

HÄFELE



www.hafeleindia.com

SLIDING DOOR SOLUTIONS



Introduction

Dear Customer,

Häfele has pioneered the way interior fittings are sold across the globe for many years now. Being a German company, our foremost concern has always been to offer our customers, premium quality products at competitive prices paired with solution based services. On the parallel, our focus has also remained to provide optimum functionality, enabling our customers to enjoy the benefits of effective utilization of space within and around their living, working or recreational environments. As a result of this, Häfele brings to you the advantage of 'space-efficiency' with its SLIDO range of Sliding Systems for internal partitions, furniture, wardrobes etc. that bring enormous versatility and design in dividing, uniting or optimizing spaces in a given area.

Sliding doors are not just for small apartments where they save space but they also add style and panache to every interior. Therefore, the demand for elegant sliding systems has grown by leaps and bounds over the past years as the market has started to appreciate the obvious advantages of such products which range from aesthetics to space saving. At Häfele, sliding fittings for all kinds of doors, Wood, Glass and Aluminium, Movable partition walls, Automatic sliding, as well as sliding fittings for sophisticated wardrobes, are an essential part of our offering. Häfele has engineered solutions for every sliding application for many years and is now one of the global leaders in this product category.

With Häfele's new and improved Wardrobe systems for wood and glass applications (Classic and Design Duo 80), you can now achieve applications with doors going as heavy as 80 kgs. Moreover, for 3 door applications, these systems now allow the central door to move in both directions offering better access to the wardrobe. Needless to mention, the new and improved Classic and Design Duo 80 systems come with integrated soft-close allowing for feather-smooth movements of heavy doors.

For Architectural Sliding, Häfele's Classic and Design 120 series (for wooden and glass doors respectively) allows the possibility of astutely installing heavy-duty doors going up to 120 kg. Moreover, with the same sliding gear, you can now create applications ranging from 500 to 1500 mm wide. These heavy-duty doors can be moved around with complete ease and flexibility; the system comes with Häfele's integrated soft-close mechanism, Smuso that makes the entire experience of moving these doors very convenient.

Häfele's SLIDO Range now also includes, for the very first time, a completely automatic door solution – the Autotec Alpha Drive. This new system comes with state-of-the-art

technology to operate doors as heavy as 125 kg with complete integrated automation. The system also includes an "energy efficiency mode" where the power consumption can be reduced to literally 0.5 W when the system moves to the "stand-by" mode.

Over the past 2 years we have launched many innovations which have made sliding doors run smoother and close softer. We have worked on making our fittings easier to install so that our customers get the best experience out of every fitting. We have expanded the range to give our customers the widest choices for every possible application. AND we make everything to last for many years of trouble free operation. With this new SLIDING DOOR SOLUTIONS catalogue, we offer you the details of these new sliding systems as well as a comprehensive guide to our entire range. This catalogue now includes all technical details including carcass dimensions, to aid easy ordering, preparation and installation of our sliding systems.

It does not stop there however. Understanding the needs of our customers, we have also further invested in qualified technical support staff to assist you and your contractor in the proper fitting of these often very advanced sliding products. In addition to this, we are now offering direct installation services to our customers and contractors under the "Meister Service" Initiative. We now have in place a highly trained technical staff who is Meister certified on some of the most sophisticated SLIDO products, stationed across South Asia. This way we want to ensure that every SLIDO product performs the way it is intended to and provides you with many years of convenience and joy of use.

So, go through the latest additions to our Sliding Range and visit our Design Showrooms for an informed dialogue with me or the Häfele team. We look forward to partnering with you and assisting every need you may have to make your dream homes a reality.

Jürgen Wolf
Managing Director
Häfele South Asia

Hafele

Reassuring Expertise



"For over 9 decades, we've been helping people make more of their homes.

Established in Germany, and now operating worldwide, we specialise in the fittings, hardware and systems that improve the way your home, works. So when you choose our products as part of your new or reformed home, you know you're getting the benefit of extensive knowledge and decades of experience.

And we're still a family business, owned and managed by family members who really care about the products and service we provide. You can rely on our commitment to the highest standards of quality and reliability, founded on a long tradition of German engineering where attention to detail is second nature.

All our home improvement ideas are built to last – day in, day out – we want you to get the very best from every corner of your home, for many years to come."

Häfele Worldwide



With its origin in 1923 in a small town named 'Nagold' from the Swabian region of Germany that nurses a passion for hardware technology, it is no surprise that Häfele has lived up to its roots through a successful presence in the architectural and furniture hardware industry for over 9 decades now. Today, Häfele's worldwide penetration includes 38 subsidiaries across Europe, America, Asia, Australia and New Zealand. With these subsidiaries and numerous other sales organisations, Häfele operates in over 150 countries. The Häfele headquarters, 4 manufacturing units and 10 sales offices are located within Germany; while 1 manufacturing unit is located at Budapest, Hungary. The company also owns one of the largest and most sophisticated warehouses in its home country. The Häfele worldwide workforce is empowered by a base of over 7800 employees.

The group services over 150,000 customers across the globe through its extensive range of hardware products and a comprehensive logistics system. In addition to this, Häfele also provides consultative services to its customers, educating and advising them about buying the correct hardware as per their requirements. With this level of market penetration and ability to handle worldwide demand, it comes as no surprise that the company is an authority in the segment of home interior solutions; what is pleasantly surprising, though, is that in spite of its size, Häfele still remains a family owned and run business with a unique, friendly and value-centric work culture which is strongly followed among all its subsidiaries.

Hafele India

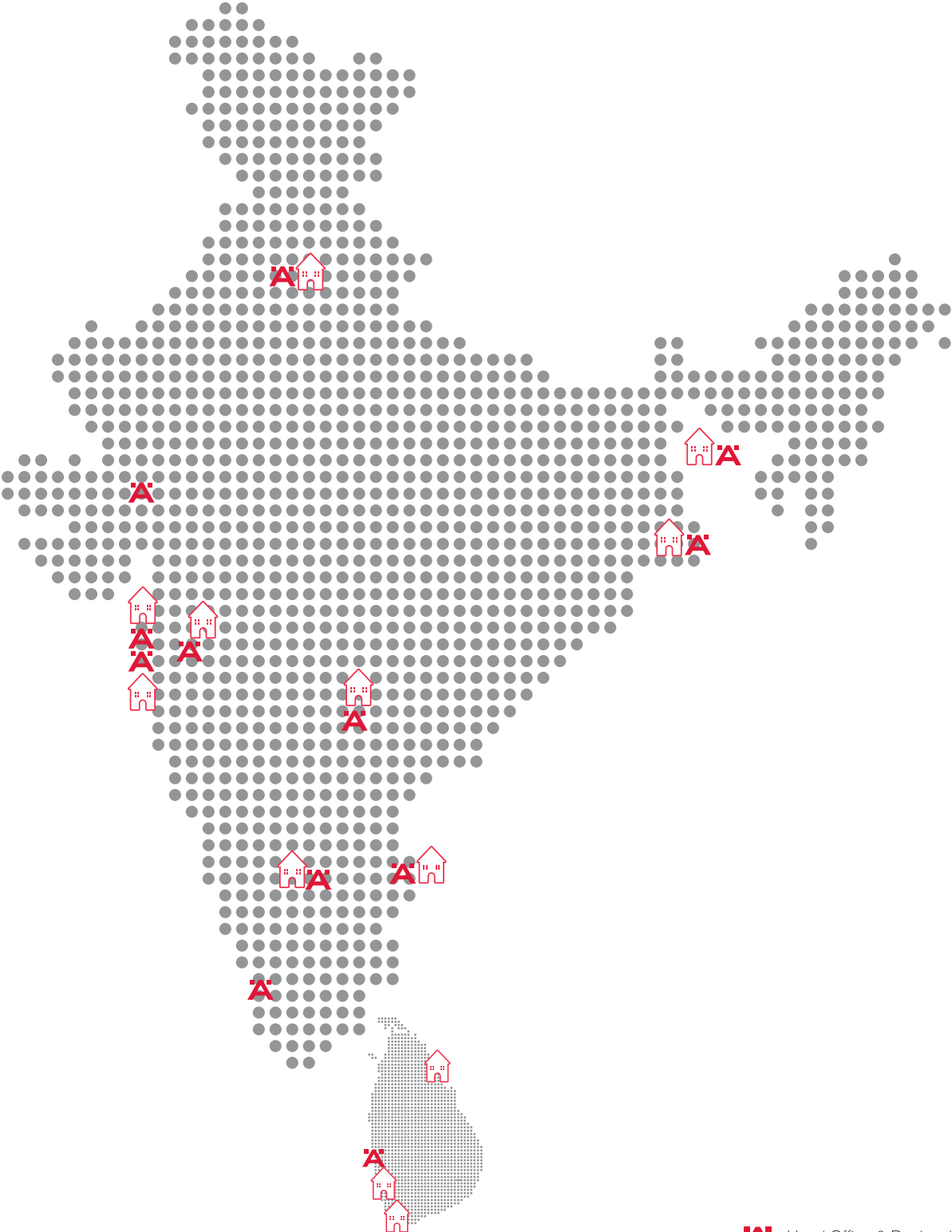

 Head Office & Regional Offices

 Hafele Design Showrooms



Häfele India is a wholly-owned subsidiary of the Häfele Global network and has been operating in India since 2003 under the leadership of Mr. Jürgen Wolf (Managing Director). The ability of the company to understand the diverse Indian market has made it an authority in the field of architectural hardware, furniture and kitchen fittings and accessories. The company also has a strong presence in synergized product categories namely Appliances, Lights, Sanitary and Surfaces catering to the focused demand from these industries.

The subsidiary has a strong nation-wide presence with offices in Mumbai, Pune, Ahmedabad, Bangalore, Chennai, Hyderabad, Delhi, Kolkata and Cochin. It has full-scale operations in Sri Lanka and Bangladesh with Regional offices and Design Showrooms in both the countries; and has also spread its operations to other regions of South Asia including Nepal, Bhutan and Maldives.

Häfele's design showrooms are hubs of international home interior trends and cutting edge designs presented in a world-class environment, where customers can see home solutions in their inherent applications. These showrooms function as a one-stop-shop for all home interior and improvement needs - from providing in-depth technical advice to kitchen and wardrobe designing services through a team of experts stationed at the showroom.

Häfele India services its customers with a base of over 850 employees, a well-networked Franchise base of over 130 shops along with over 1000 dealers situated across South Asia. The subsidiary has a sophisticated Logistics centre in Mumbai along with distribution centres in Delhi, Bangalore, Kolkata and Colombo respectively.

1

Why Häfele?

INSTANT SUPPLY

A perfectly functioning logistics system is mission-critical to an organization that carries thousands of different articles in its assortment and ships country wide. Häfele India houses a State of the Art Logistic Facility with excellent integration of information flow, material handling, packaging, inventory, transportation, warehousing, and is a hub for hardware technology all under one roof.

Located over a space of 16000 sq. mt. in Bhiwandi, the warehouse is centrally managed for India and its neighbouring countries under Indian operation. Almost 10,000 articles stored over 20000 locations within the premises are in constant inventory and are ready to be shipped from this location. A specialized team of over 30 personnel fill over 200 orders daily.

95% of orders that are received before 1 pm for package shipment are filled the same day and delivered the following day. At the Häfele Warehouse, though the dispatch is done through Surface, Air and Water, 10 vehicles run on a daily basis to ship the desired quantities in the shortest possible time.

In recent years, Häfele has widened its logistics services by opening Regional Logistics Centres in Gurgaon, New Delhi (7500 sq. mt.), Kolkata (2300 sq. mt.), Bangalore (7500 sq. mt.) and Colombo (1600 sq. mt.). These centres cater to the logistics demand from the North, East and South regions, and Sri Lanka respectively and are stocked with articles that move fast in these specific markets. These centres each, house an efficient team of employees who specialize in warehouse operations and manage timely deliveries of orders on a day-to-day basis. By achieving an extent of decentralization of services through these centres, we can now assure our customers faster, safer and more accurate delivery of orders.





SCHAEFER
WIRTSCHAFTS-TRUCK-TRAGUNG
WICHTIGE TRAGUNGSHINWEISE

Symbol	Tragungsart	Tragelast (kg)
🟡	Einseitig	1000
🟢	Zweiseitig	1000
🔴	Einseitig	500
🟡	Zweiseitig	500

WICHTIG: Die Tragelast ist nur bei korrekter Lagerung und bei Einhaltung der zulässigen Höhe zu erreichen. Bei Überladung oder falscher Lagerung kann es zu Schäden an der Ladung und an den Regalen kommen.

2

Sliding Competence Centre SCC





The Sliding systems offered by Häfele are diverse in benefits yet unique in functionality. Our offering includes the best in sliding fittings from across the globe as well as a range from Häfele's own-house assortment (OHA). Häfele's in-house Sliding Systems are engineered, designed, developed and manufactured at the Sliding Competence Center (SCC) located in Hungary, Budapest. The production plant was founded as Huwil Kft. in 1991. Today the facility is an integral part of five Häfele production plants overall, whose products are available through 37 Häfele sales offices in 150 countries worldwide.



3

Hafele difference

INTERNATIONAL PROJECTS



Hilton, Sydney, Australia



Burj Al Arab, Dubai,
United Arab Emirates



Sheraton Krabi Beach Resort,
Krabi, Thailand



Hotel Termag, Jahorina
Mountain, Bosnia-Herzegovina



The Setai South Beach,
Miami, USA



Park Hyatt Baku, Azerbaijan



JW Marriott, Seoul, Korea



Panoramahaus Hotel,
Dornbirn, Austria



H2O-Hoteltherme,
Bad Waltersdorf, Austria,

4

Hafele difference

INDIAN PROJECTS



Four Season, Mumbai



Hyatt Regency, Mumbai



Intercontinental, Mumbai



J.W.Marriot, Mumbai



Le Meridian, Mumbai

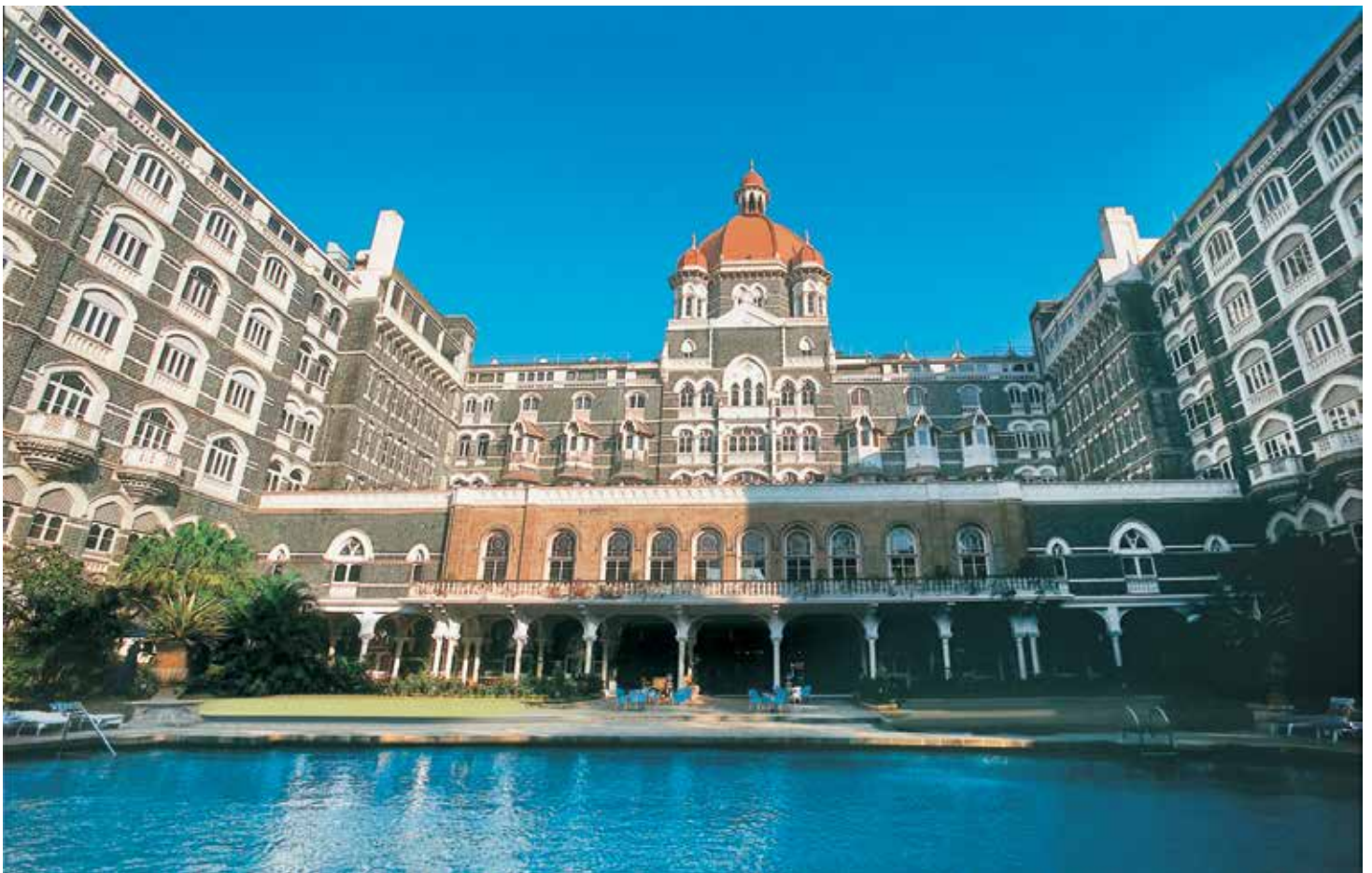

Taj Mahal Hotel, Mumbai

5

Introduction to SLIDING SYSTEMS

Sliding systems are used for doors that open horizontally. They can either be mounted on or suspended from an aluminium track. Sliding doors are primarily used for aesthetics and in places where it is not possible to install a door on Hinges or Floor Spring.

Advantages of using a Sliding system:

The biggest advantage of using sliding systems, apart from the obvious aesthetic appeal, is that they are space-efficient. While a hinged door takes up a lot of floor space when it is opened, sliding doors on the other hand move horizontally. The floor space, thus saved, can be used to add a home decorative or piece of furniture without interfering with the door movement.

The other benefits of using a sliding system can be:

- Design – Sliding doors add an element of design to home interiors; you have the option to conceal the hardware (roller sets and tracks) in false ceilings in case of some systems – which gives the door a clean, flush look.
- Functionality – Sliding Systems allow you to add new dimensions to home interiors by dividing rooms into different sections while optimizing space.
- Provide overview and access to cabinets- Sliding doors, when opened, move completely out of your way and allow for a wide opening and maximum access to even the remotest corners of wardrobes and cabinets.
- Realization of wide openings - Sliding doors can separate and unite rooms as and when required; once the leaves are folded and parked aside they allow for a wide opening, merging spaces to create a larger room.

Installation of Sliding Systems:

Sliding systems can either be installed from the top using a Top hung system or at the base using a Bottom rolling system:

Top hung: The top-hung sliding systems are very commonly used. The door is hung by two trolley hangers at the top of the door running in a concealed track and needs additional guides at the bottom. All the weight is taken by the hangers, making the door easy to move.

Bottom rolling: Bottom rolling is used when top-hung mechanism cannot be installed. It consists of two rollers at the bottom of the door running on a track and two guides at the top running in a guide channel. Weight of the door is concentrated on the two bottom wheels-more force is needed to move the door.

Components of a Sliding System:

Generally Sliding systems come with the following installation components:

1. Hanger Fitting Set
2. Top Track
3. Roller Set
4. Bottom Guide/ Bottom Pivot
5. Bottom Track (relevant in case of only some sliding systems)

NOTE: The track is NOT part of the sliding set – it has to be ordered separately. The components for each type of sliding system may vary as per the specific function of that system.

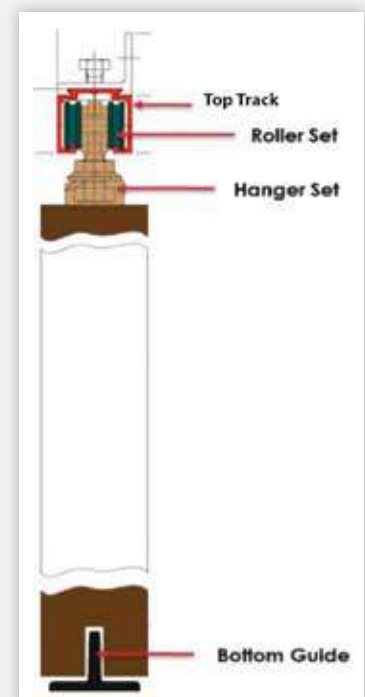

Principles of Hardware Selection

The selection of hardware depends on one or more of the following factors:

- Height
- Width
- Thickness
- Weight
- Material
- Application

The height, width and thickness are readily available however the weight needs to be calculated depending on the specific gravity of the material:

Weight calculation for wood

$$\text{HEIGHT (meters)} \times \text{WIDTH (meters)} \times \text{THICKNESS (meters)} \times 700 \text{ (kg/m}^3\text{)}$$

Weight calculation for glass

$$\text{HEIGHT (meters)} \times \text{WIDTH (meters)} \times \text{THICKNESS (meters)} \times 2500 \text{ (kg/m}^3\text{)}$$

Important Conversions:

- Feet to Millimeters - Feet x 12 x 25.4 = Millimeters
- Inches to Millimeters - Inches x 25.4 = Millimeters
- Centimeters to Millimeters - Centimeters x 10 = Millimeters
- Millimeters to Meters - Millimeters / 1000

Key Principles for Selection of Sliding Systems:

- Weight is the most important criterion for selection of any sliding system
- Once the weight of the material is ascertained, the next most important factor to be considered is the application.

Types of sliding door systems:

As per the application of the door, sliding systems can be classified into the following 3 categories:

- **Straight Sliding** - The door moves in a straight direction either to the left or right – can use one door panel only in one direction
- **Sliding & Folding** - The door slides and folds and can be parked on one side of the door opening - can use multiple door panels
- **Syncro Sliding** - Two doors open simultaneously in opposite directions; when you open one door the other door opens automatically.

Straight Sliding System



- **Function:** Moves in a straight direction either to the left or right depending on the installation of the door
- **Applications:** Internal doors, Wardrobes

Weight Calculation: The weight is calculated for a single door and the sliding fitting is selected accordingly.

- One pair of rollers carries the weight of one door
- In case the door is too wide then an additional set can be used to compensate the weight.

Sliding-Folding Sliding System - End Fixing

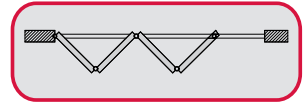

- **Function:** Slides, folds and parks itself to one side (left or right depending on the installation) of the opening width.
- **Applications:** Garden or Balcony Doors where a full opening view is required.

Weight Calculation: The weight of both the doors is necessary.

- Each roller carries the weight of two doors (or panels) hence the total weight must be equally distributed. E.g. If the roller can carry 50kg then each door (or panel) must not exceed 25kg.

Sliding-Folding Sliding System - Center Fixing

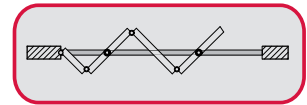

- **Function:** Slides, folds and parks itself to one side (left or right depending on the installation) of the opening width; with center fixing, there is enough space available on either side of the panels.
- **Applications:** Internal Doors in corridors or between two rooms (kitchen and dining room or dining and drawing room).

Weight Calculation: The weight of both the doors is necessary.

- Each roller carries the weight of two doors (or panels) hence the total weight must be equally distributed. E.g. If the roller can carry 50kg then each door (or panel) must not exceed 25kg.

Syncro Sliding System

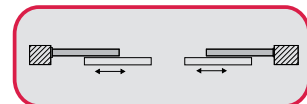

- **Function:** Two doors synchronized to slide in opposite directions; if you move one door, the other one moves automatically; this system can be plugged with a sensor system that automatically opens the doors on sensing the presence of an object or person
- **Applications:** External Doors to Malls, Offices, Hotels etc.

Weight Calculation: The weight is calculated for a single door and the sliding fitting is selected accordingly.

- One pair of rollers carries the weight of one door
- In case the door is too wide then an additional set can be used to compensate the weight.



Door Weight

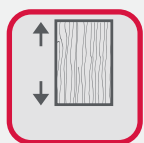

Wooden Door Height

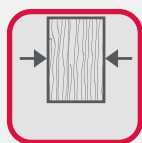

Wooden Door Width

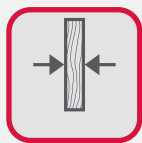

Wooden Door Thickness



System can be used for Wood & Glass Doors

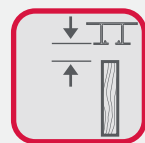

Gap between Track and Door

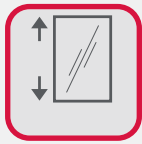

Glass Door Height

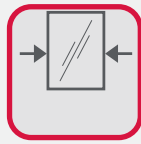

Glass Door Width

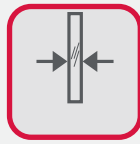

Glass Door Thickness



2 Door Application

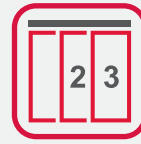

3 Door Application

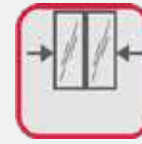

Bi-parting Door



Telescopic Progressive - 2 Doors



Telescopic Progressive - 3 Doors



E Drive



Vertical Sliding

Comparison:

	Straight Sliding	Sliding & Folding	Syncro Sliding
Bottom track	Not mandatory; bottom guide is sufficient	Is mandatory with a bottom pivot perpendicularly below the roller set	Not mandatory; bottom guide is sufficient
Sliding Carriage and rollers	One set – Pair of rollers + carriage	One Piece for alternate Shutters	Two sets – 2 Pairs of rollers, carriage
Length of tracks (top & bottom)	Width of panel X 2	Width of total opening	Width of one panel X 4



Hafele's Range of Sliding Systems:

Häfele's range of sliding systems is divided into two categories Architectural and Furniture Sliding, Architectural sliding is used for external or internal doors such as bedroom door, balcony door etc. Furniture sliding is used for cabinets, wardrobes and other furniture units.

Our range of Architectural and Furniture Sliding systems provide the following 3 applications:

Architectural Sliding	Furniture Sliding
Straight	Straight
Syncro	Syncro
Folding (end fixing and center fixing)	Folding (end fixing and floating)

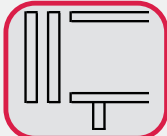
The Furniture sliding doors may be installed in any of the 3 ways:

Vor Front	In Front	Mix Front
Shutter is fixed in a way that it covers the cabinet sides	Shutter is fixed inside the cabinet	Shutter is fixed in a way that it falls inside the cabinet, on the top (In front) while it covers the base of the cabinet (Vor front)
		

Product Range Specifications

Criterion	Available In
Sliding Gears	Top Hung and Bottom Rolling
Sliding Systems for Applications	Straight Sliding, Sliding & Folding, Syncro Sliding
Sliding and Folding Systems	End fixing and Center fixing
Door Materials	Timber, Glass, Aluminium profiles, combination of any of these 3
Applications	Doors, Wardrobes, Furniture units and Shower Cubicles
Material of rollers	Nylon

WOOD - HOW TO ORDER?

Step 1: Calculate the weight of the door.

Step 2: Check if the weight carrying capacity of the system is compatible with the weight of the door.

Step 3: Find the width of the door and order the kit.

Step 1 SAMPLE CALCULATION

Height	Width	Thickness	S= Specific gravity of wood	Calculation H x W x T
2.5m (2500mm)	1.2m (1200mm)	0.035 m (35mm)	700 Kg/m ³	2.5 x 1.2 x 0.035 x 700 = 73.5 Kg

Step 2 COMPATIBILITY

Checking the specification:

Classic 80W - Weight carrying capacity 80kg: Compatible

Step 3 ORDERING OF ARTICLES

KIT TO ORDER

Width of Door	Length of track (width of the door x 2)	Kit to order	Ordering Description
1200mm	2400mm	XXX.XX.XXX	Classic 80 with 3m track

BOM FITTING SET

Article No.	Description	Quantity
XXX.XX.XXX	Classic 80 W with 2.1m track	1 Set

CONSISTING OF

Article No.	Description	Quantity
XXX.XX.XXX	Complete set of accessories for Classic 80 W	1 Set
XXX.XX.XXX	2.1 Meters silver aluminium anodized track	1 Pc

Article No.	Description	Quantity
XXX.XX.XXX	Classic 80 W with 3m track	1 Set

CONSISTING OF

Article No.	Description	Quantity
XXX.XX.XXX	Complete set of accessories for Classic 80 W	1 Set
XXX.XX.XXX	3 Meters silver aluminium anodized track	1 Pc

GLASS - HOW TO ORDER?

- Step 1: Calculate the weight of the door.
- Step 2: Check if the weight carrying capacity of the system is compatible with the weight of the door.
- Step 3: Find the width of the door and order the kit.

Step 1 SAMPLE CALCULATION

Height	Width	Thickness	S= Specific gravity of glass	Calculation H x W x T
3 m (3000 mm)	1.5 m (1500 mm)	0.008 m (8 mm)	2500 Kg/m ³	3 x 1.5 x 0.008 x 2500 = 90 Kg

Step 2 COMPATIBILITY

Checking the specification:
 Design 120 J - Weight carrying capacity 120kg: Compatible

Step 3 ORDERING OF ARTICLES

KIT TO ORDER

Width of Door	Length of Track (width of the door x 2)	Kit to order	Ordering Description
1500 mm	3000 mm	XXX.XX.XXX	Design 120 J

WARDROBE- HOW TO ORDER?

- Step 1: Calculate the weight of the door.
- Step 2: Check if the weight carrying capacity of the system is compatible with the weight of the door.
- Step 3: Find the width of the door and order the kit.

Step 1 SAMPLE CALCULATION

Height	Width	Thickness	S= Specific gravity of wood	Calculation H x W x T
2 m (2000 mm)	1.5 m (1500 mm)	0.018 m (18 mm)	700 Kg/m ³	2 x 1.5 x 0.018 x 700 = 37.8 Kg

Step 2 COMPATIBILITY

Checking the specification:
 Classic IF 45 Weight carrying capacity 45 kg: Compatible

Step 3 ORDERING OF ARTICLES
TRACK

Width of Door	Length of Track (width of the door x 2)	Kit to order	Ordering Description
1500 mm	3000 mm	XXX.XX.XXX	Classic IF 45 with 3 m track

BOM FITTING SET

Article No.	Description	Quantity
XXX.XX.XXX	Classic IF 45 with 3m track for single door	1 Set
CONSISTING OF		
Article No	Description	Quantity
XXX.XX.XXX	Fitting set for Classic IF 45	1 Set
XXX.XX.XXX	Brake stop for Classic IF 45	1 pc
XXX.XX.XXX	Single track for Classic IF 45 - 3 m silver anodised, height- 26 mm	1 pc



CONTENTS

SLIDO WOOD - ARCHITECTURAL

PAGE

26-94

Classic 80 W	28
Classic 80 XL	31
Classic 120 W	34
Classic 120 F	37
Classic 120 XL	40
Classic 60 W/120 W Sumso	43
Classic 120 XL Sumso	46
Classic 175	50
Classic 300 W	53
Classic 500	56
Classic 120 S	59
Fold 50 EF T	62
Weatherfold 100 EF	65
Fold 80 EF	70
Fold 150 CF	75
Classic 80 M	78
Classic Telescopic Progressive 80	84
Insect Screen	90

SLIDO GLASS - ARCHITECTURAL

PAGE

96-163

Design Ergo 80	98
Design Ergo 120	101
Design Ergo 120 Smuso	104
Design 120 J	107
Design 120 J Sumso	111
Design 120 SS	115
Design 120 SS Smuso	118
Design 80 L	121
Design 80 SVX	124
Design 80 M	128
Design 85 SV	133
Design 100 C	136
Design 80 SYTL	139
Design 80 SY	142
Design 200	145
Design 100 SF 101	149
Design Telescopic Progressive 80	155
Eclipse 40	160
Eclipse 150	162

SLIDO WARDROBE - FURNITURE

PAGE

164-238

WOOD

Classic IF 45	168
Classic IF 50	173
Classic 50 VF S (ST-18)	178
Classic 50 VF SR (ST-18)	183
Smuso CD Soft Closing Mechanism	187
Classic 60 VF	189
Classic Duo 80 VF	195
Fold 40 MF	202
Slide Fold 25/50	206
Saliscendi	214
Dumezzi	217

GLASS

Design 50 VF SR (ST-18)	219
Design 60 VF	224
Design Duo 80 VF	232

SLIDO AUTOMATIC

PAGE

239-268

E-Drive	239
Autotec Alpha	252
Autoslide	262

ARCHITECTURAL WOODEN DOOR SLIDING SYSTEMS

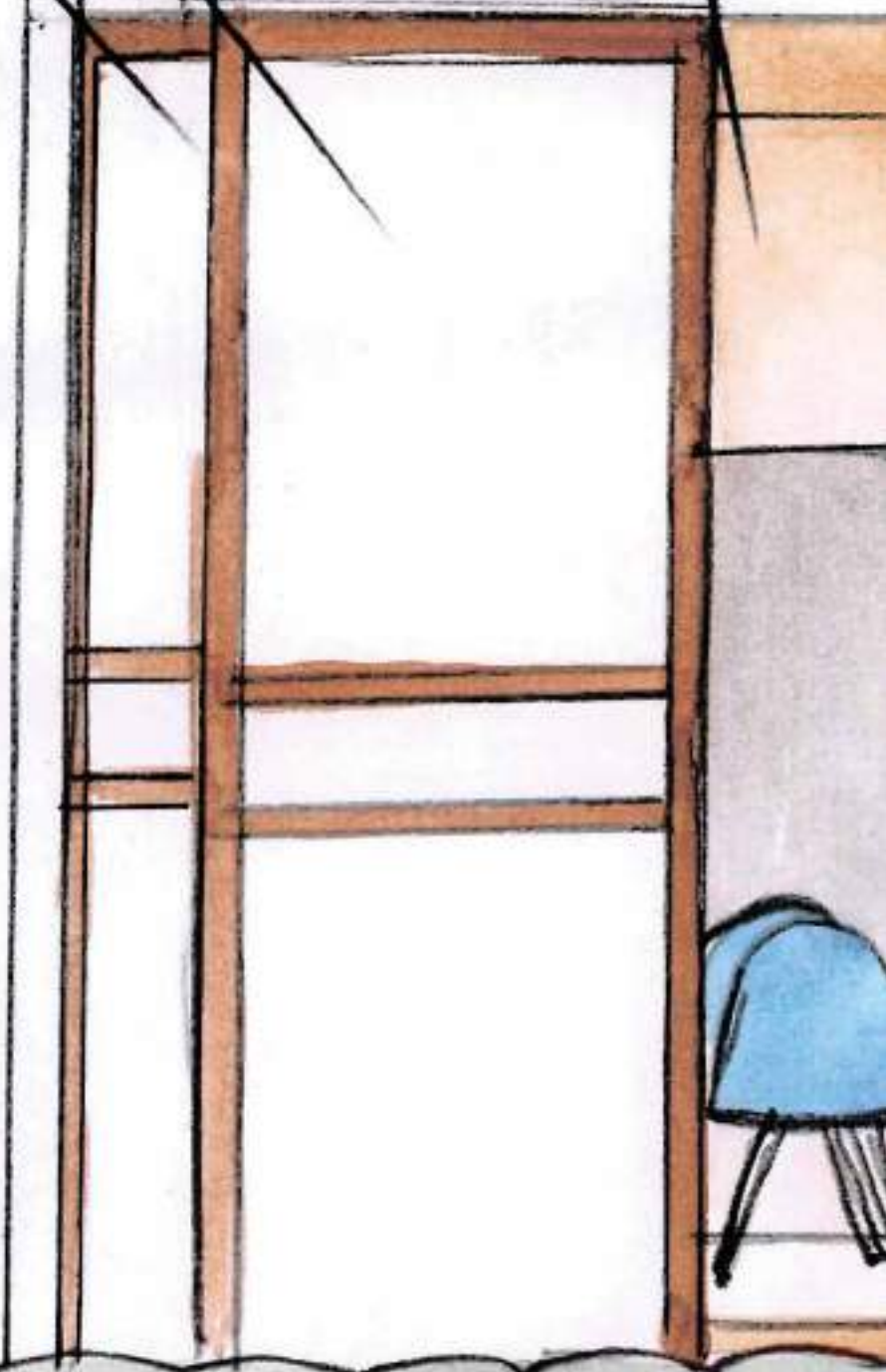
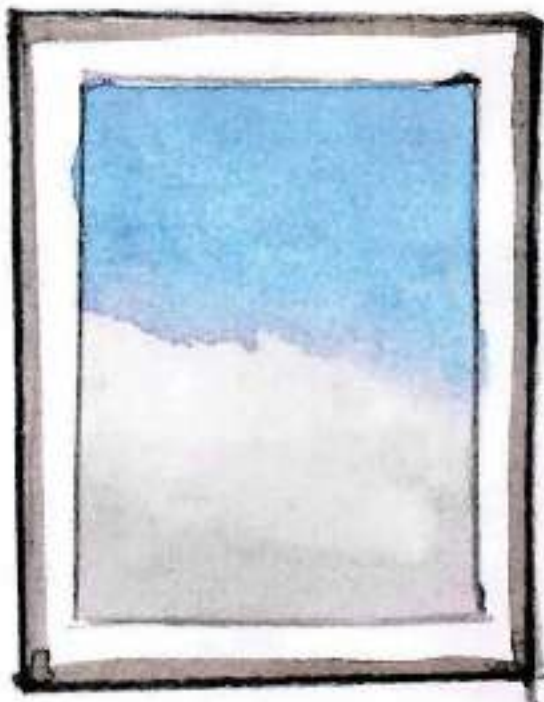



Classic 80 W

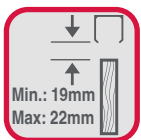
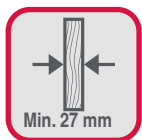
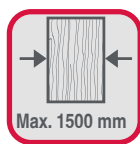
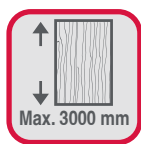

Straight sliding system for wooden doors.

Hardware Specification:





- Ideal for dividers and internal doors
- An elegantly designed top quality system
- Concealed lower guide
- Rollers come with an elastic system for absorbing the irregularities of profile (If any)
- High quality Zamak aluminium body
- Proven smooth and silent rolling, thanks to our special anti dust ball bearing system
- Rollers for long lasting rolling durability

Note: If you place the order using the individual components (as listed below), please order the track separately. Alternately if you place the order using the BOM Articles (mentioned in the BOM LIST table), the track is included.



Article No.: 409.79.020
 Sliding door kit consists of:

- 2 Rollers with Bracket
- 1 Bottom Guide
- 2 Adjustable Stoppers and other fittings

Product Name	Article No.	 L mm	
Aluminium anodized top track	409.50.602	2100 mm	
Aluminium anodized top track	941.27.432	3000 mm	
OPTIONAL			
Product Name	Article No.	Thickness	
Wall mounting bracket	940.66.060	3 mm	

BOM LIST (Track Included)	
Description	Article No.
Classic 80 W with 2.1 m track	940.99.304
Classic 80 W with 3 m track	940.99.305

**Section View:
Wall Mounting**

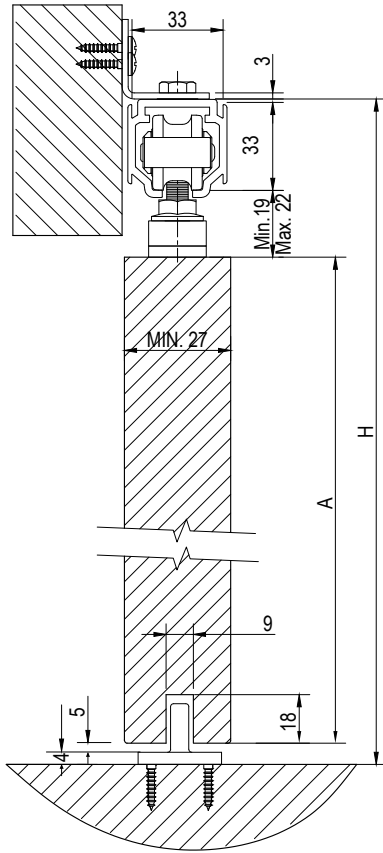

Ceiling Mounting

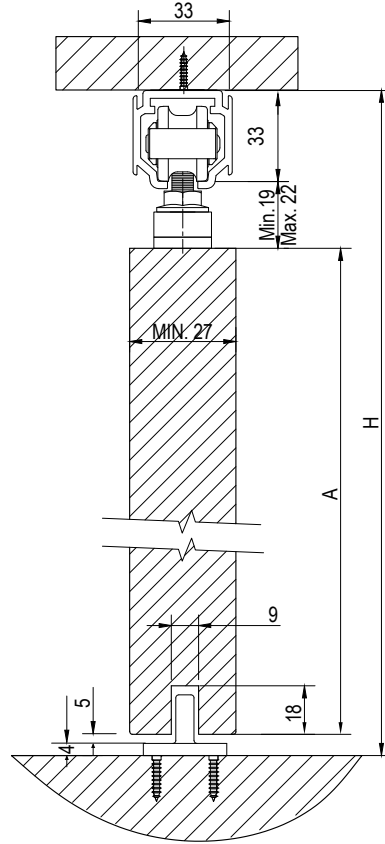

Door Height (A) = Total Height Clearance (H) - [Track Height (Non Concealed) + Desired Gap (Top+ Bottom)]

Track Dimension:

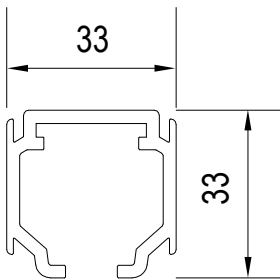

Bottom Guide Cross Section:

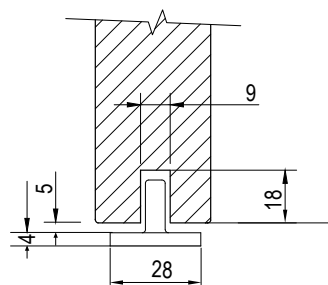

Classic 80 XL

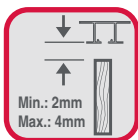
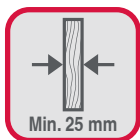
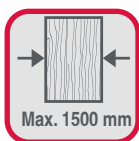
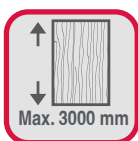

Straight sliding system for wooden doors.
Track concealed in false ceiling.

Hardware Specification:

- Ideal for dividers and internal doors
- An elegantly designed top quality system
- Silent-running rollers
- Vertical adjustment mechanism
- Concealed lower guide
- Rollers come with an elastic system for absorbing the irregularities of profile (If any)

Note: If you place the order using the individual components (as listed below), please order the track separately. Alternately if you place the order using the BOM Articles (mentioned in the BOM LIST table), the track is included.



Article No.: 940.99.000

Sliding door kit consists of:

- 2 Rollers with Concealed Bracket
- 1 Bottom Guide
- 2 Adjustable Stoppers and other fittings



Product Name	Article No.	L mm	
Aluminium anodized top track concealed	940.99.230	3000 mm	
Aluminium anodized top track	941.27.432	3000 mm	

BOM LIST (Track Included)	
Description	Article No.
Classic 80 XL with 3 m track concealed	940.99.235
Classic 80 XL with 3 m track	940.99.302

**Section View:
Concealed Mounting**

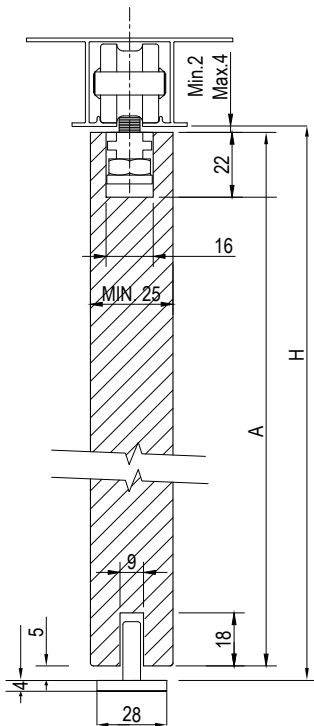

Door Height (A) = Total Height From The False Ceiling (H) - Desired Gap (Top+Bottom)

Wall Mounting

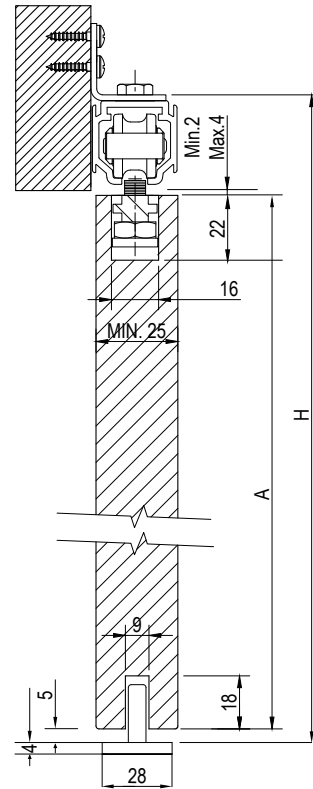

Door Height (A) = Total Height Clearance (H) - [Track Height (Non Concealed) + Desired Gap (Top+ Bottom)]

Elevation View:

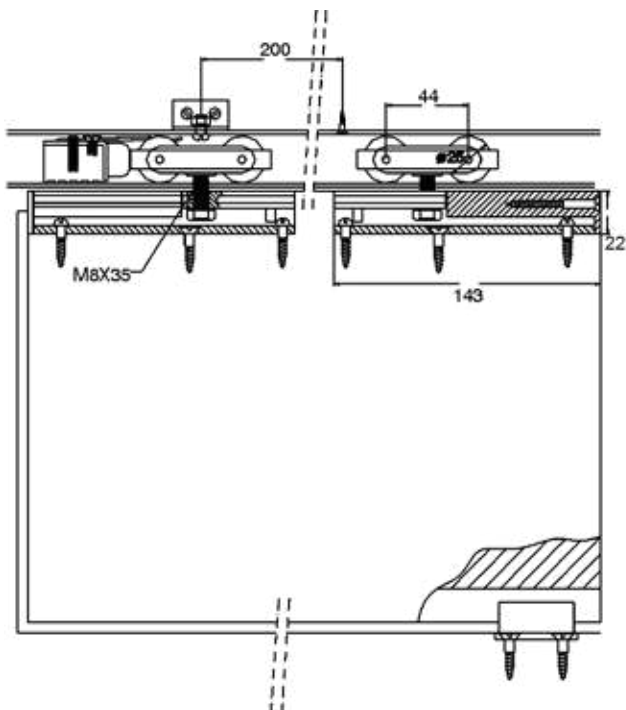

Track Dimension:

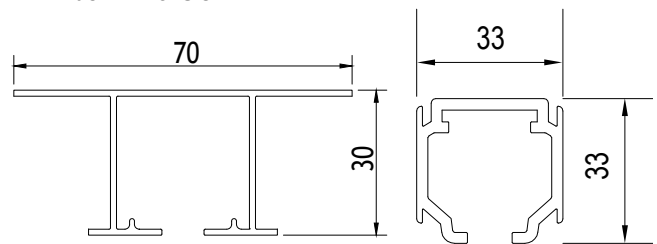

Bottom Guide Cross Section:

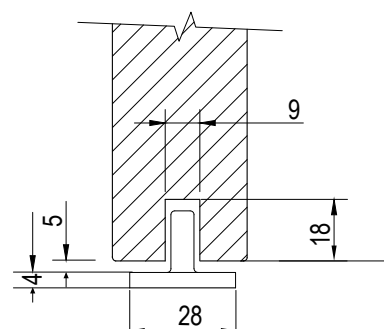

NEW Classic 120 W

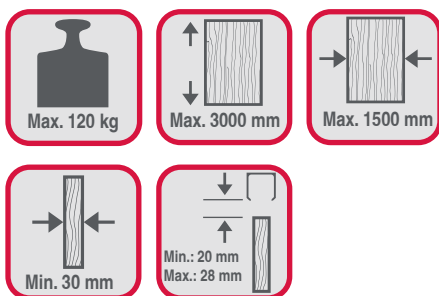

Straight sliding system for wooden doors.

Hardware Specification:

- Solid rollers made of high quality Zamak one piece die casting
- Ground Shielded ball bearing for silent sliding
- Wheel made up of Delrin, special anti wear compound
- High tech hanger made of high quality Zamak alloy with solid structure and discrete design
- Adjustable bottom guide for perfect alignment of the door run







Article No.: 941.10.027
Sliding door kit consists of:

- 2 Rollers with Bracket
- 1 Bottom Guide
- 2 Adjustable Stoppers and other fittings



Product Name	Article No.		
Aluminium anodized top track (Note: Track to be ordered separately)	941.10.915	1524 mm	
	941.10.918	1828 mm	
	941.10.921	2134 mm	
	941.10.924	2438 mm	
	941.10.927	2743 mm	
	941.10.930	3048 mm	
	941.10.936	3657 mm	
OPTIONAL			
Product Name	Article No.	Thickness	
Wall mounting bracket	940.66.060	3 mm	



Classic 120 F

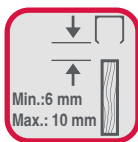
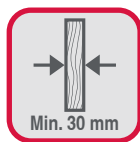
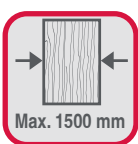
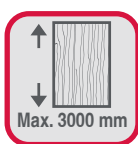

Straight Flush sliding system for wooden doors.



Hardware Specification:

- Brackets are flushed in the door thus reducing the gap between the track and door to 6mm
- Solid rollers made of high quality Zamak one piece die casting
- High tech hanger made of high quality Zamak alloy with solid structure and discrete design
- Adjustable bottom guide for perfect alignment of the door run
- Height Adjustment $\pm 4\text{mm}$

Article No.: 941.10.036
Sliding door kit consists of:

- 2 Rollers with Flush Bracket
- 1 Bottom Guide
- 2 Adjustable Stoppers and other fittings



Product Name	Article No.	 L mm	
Aluminium anodized top track (Note: Track to be ordered separately)	941.10.915	1524 mm	
	941.10.918	1828 mm	
	941.10.921	2134 mm	
	941.10.924	2438 mm	
	941.10.927	2743 mm	
	941.10.930	3048 mm	
	941.10.936	3657 mm	
OPTIONAL			
Product Name	Article No.	Thickness	
Wall mounting bracket	940.66.060	3 mm	

**Section View:
Wall Mounting**

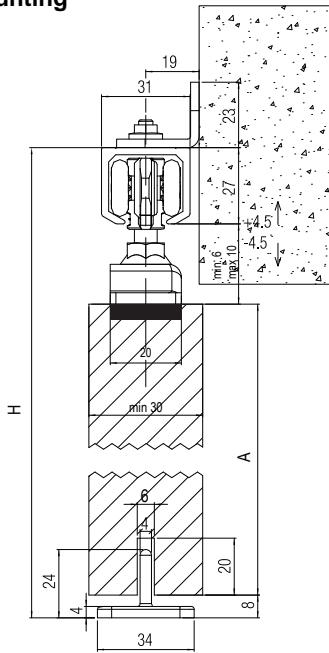

Ceiling Mounting

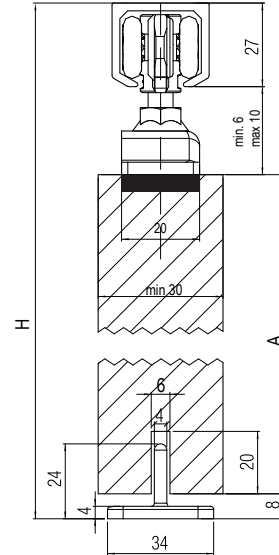

Door Height (A) = Total Height Clearance (H) - [Track Height (Non Concealed) + Desired Gap (Top+ Bottom)]

Elevation View:

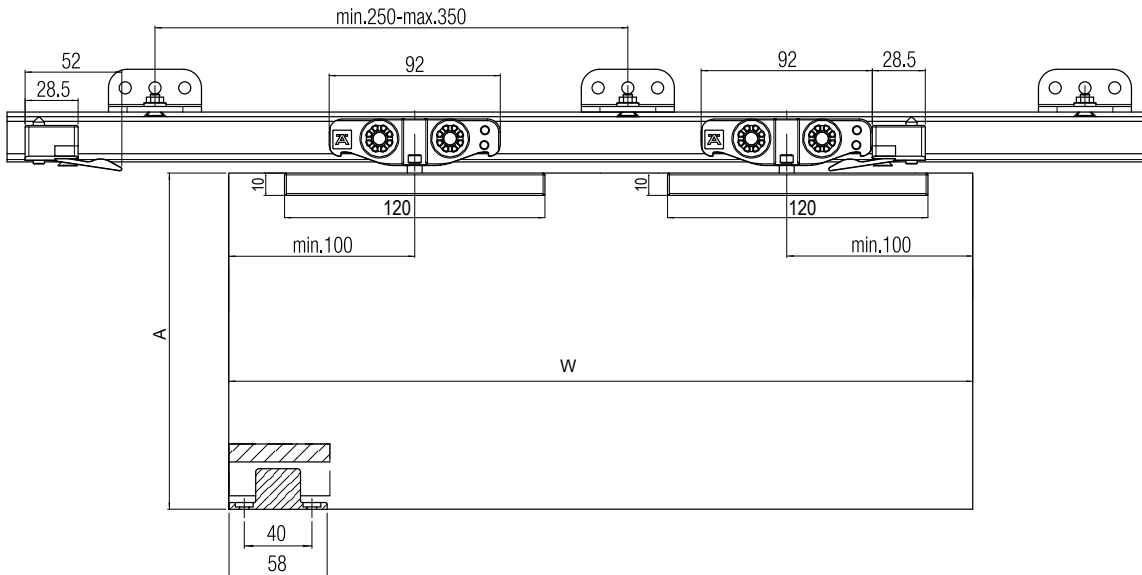

Track Dimension:

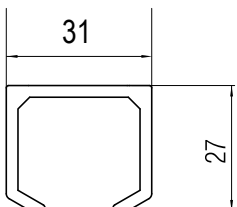

Bottom Guide Cross Section:

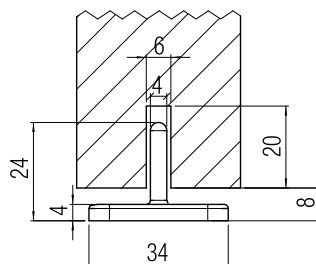

Door Cut-out:

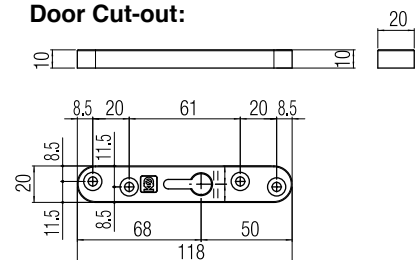

NEW Classic 120 XL

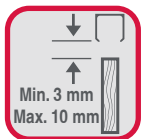
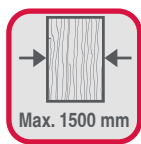
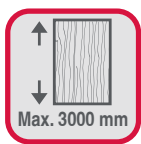

Straight flush sliding system for wooden doors.

Hardware Specification:

- Brackets are flushed in the door thus reducing the gap between the track and door to 3 mm
- Solid rollers made of high quality Zamak one piece die casting
- High tech hanger made of high quality Zamak alloy with solid structure and discrete design
- Adjustable bottom guide for perfect alignment of the door run
- Height Adjustment $\pm 3\text{mm}$





Article No.: 941.10.029

Sliding door kit consists of:

- 2 Rollers
- 2 Brackets concealed in door
- 1 Bottom guide
- 2 Adjustable stoppers and other fittings



Product Name	Article No.		
Aluminium anodized top track (Note: Track to be ordered separately)	941.10.915	1524 mm	
	941.10.918	1828 mm	
	941.10.921	2134 mm	
	941.10.924	2438 mm	
	941.10.927	2743 mm	
	941.10.930	3048 mm	
	941.10.936	3657 mm	
OPTIONAL			
Product Name	Article No.	Thickness	
Wall mounting bracket	940.66.060	3 mm	



Classic 60 W/120 W SMUSO



Classic 60 W SMUSO

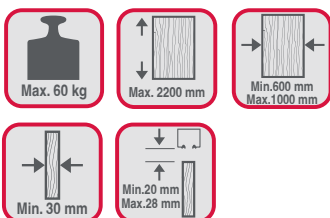

Classic 120 W SMUSO

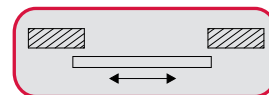
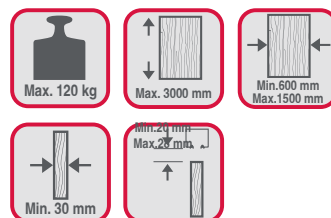

Straight sliding system with soft close
for wooden doors

Hardware Specification:

- Highly efficient double-sided soft close technology embedded into the track
- Good quality Zamak (zinc alloy) roller, hanger and carriage set body
- Ground shielded ball bearings around the wheel for silent and smooth sliding
- High tech two-way suspension brackets made of zinc coated steel. The suspension screw can be inserted from the front or the side for easy installation
- Open structure of the rail prevents dust accumulation
- Compact form of stopper does not afflict the roller wheels hence the wheels do not get damaged when the roller set hits the stopper
- Adjustable bottom guide (up to 2 mm towards the left or right) for perfect alignment



Classic 60 W SMUSO

941.10.026

Sliding door kit consists of:

- 1 Roller
- 2 Adjustable Stoppers
- 1 Bottom Guide
- 2 Brackets
- 1 Two way 60 kg Smuso with rollers
- 2 Activator
- Fixing Accessories
- Instruction Manual



Classic 120 W SMUSO

941.10.028

Sliding door kit consists of:

- 1 Roller
- 2 Adjustable Stoppers
- 1 Bottom Guide
- 2 Brackets
- 1 Two way 120 kg Smuso with rollers
- 2 Activator
- Fixing Accessories
- Instruction Manual



Product Name	Article No.		
Aluminium anodized top track (Note: Track to be ordered separately)	409.50.603	2000 mm	
	409.50.604	2400 mm	
	409.50.605	3000 mm	
	409.50.606	3600 mm	
OPTIONAL			
Product Name	Article No.	Thickness	
Wall mounting bracket	940.66.060	3 mm	

**Section View
Wall Mounting**

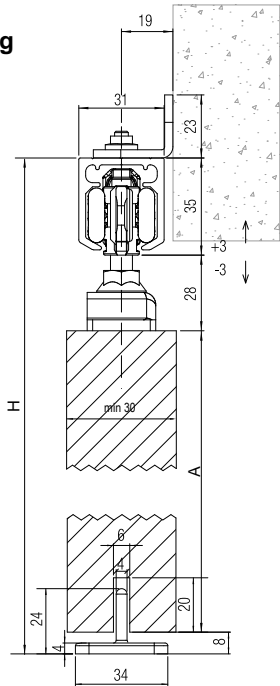

Ceiling Mounting

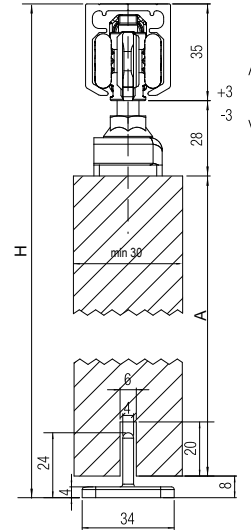

Door Height (A) = Total Height Clearance (H) - [Track Height (Non Concealed) + Desired Gap (Top+ Bottom)]

Elevation View

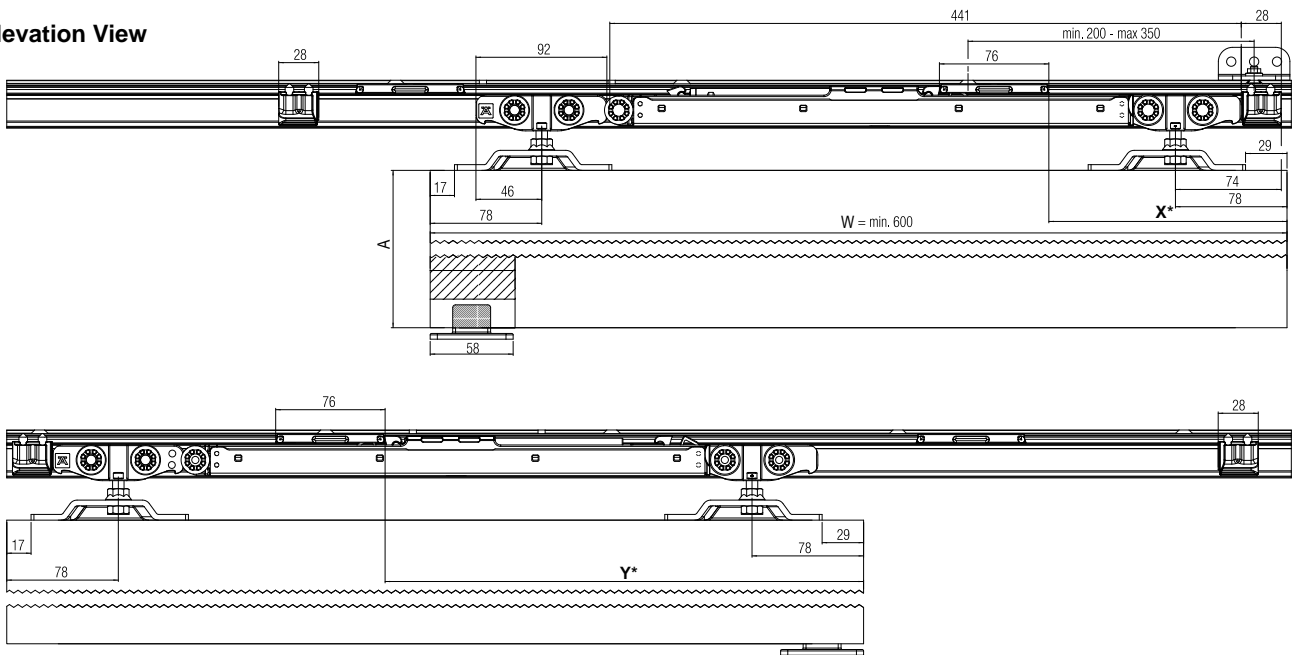

≤ 0-100 kg	≥ 100 kg
X* = 166	X* = 151
Y* = 334	Y* = 349

Track Dimension:

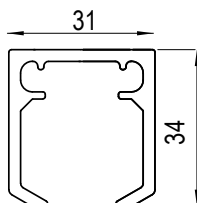

Bottom Guide Cross Section:

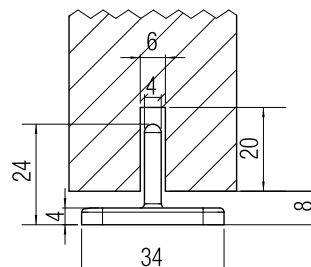

NEW Classic 120 XL
SMUSO

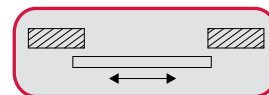
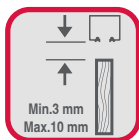
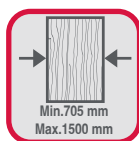
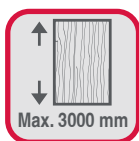

Straight sliding system with soft close for wooden doors

Hardware Specification:

- Highly efficient Double-sided Soft Close technology embedded into the track
- Good quality Zamak (zinc alloy) roller, hanger and carriage set body
- Ground shielded ball bearings around the wheel for silent and smooth sliding
- Brackets are flushed into the door, reducing the gap between track and door to 3mm
- Open structure of the rail prevents dust accumulation
- Compact form of stopper does not afflict the roller wheels hence the wheels do not get damaged when the roller set hits the stopper
- Adjustable bottom guide (up to 2 mm towards the left or right) for perfect alignment





941.10.030

Sliding door kit consists of:

- 1 Roller
- 2 Adjustable Stoppers
- 1 Bottom Guide
- 2 Concealed Brackets
- 1 Two-way 120kg Smuso with Rollers
- 2 Activators
- Fixing Accessories
- Instruction Manual



Product Name	Article No.		
Aluminium anodized top track (Note: Track to be ordered separately)	409.50.603	2000 mm	
	409.50.604	2400 mm	
	409.50.605	3000 mm	
	409.50.606	3600 mm	
OPTIONAL			
Product Name	Article No.	Thickness	
Wall mounting bracket	940.66.060	3 mm	

**Section View:
Wall Mounting**

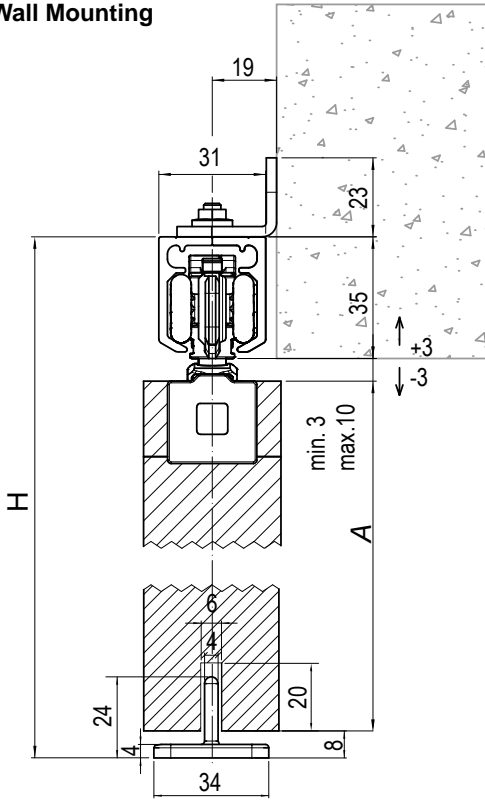

Ceiling Mounting

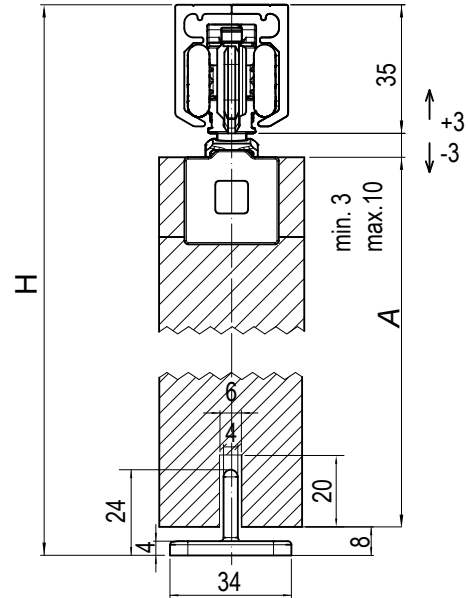

Door Height (A) = Total Height Clearance (H) - [Track Height (Non Concealed) + Desired Gap (Top+ Bottom)]

Elevation View:

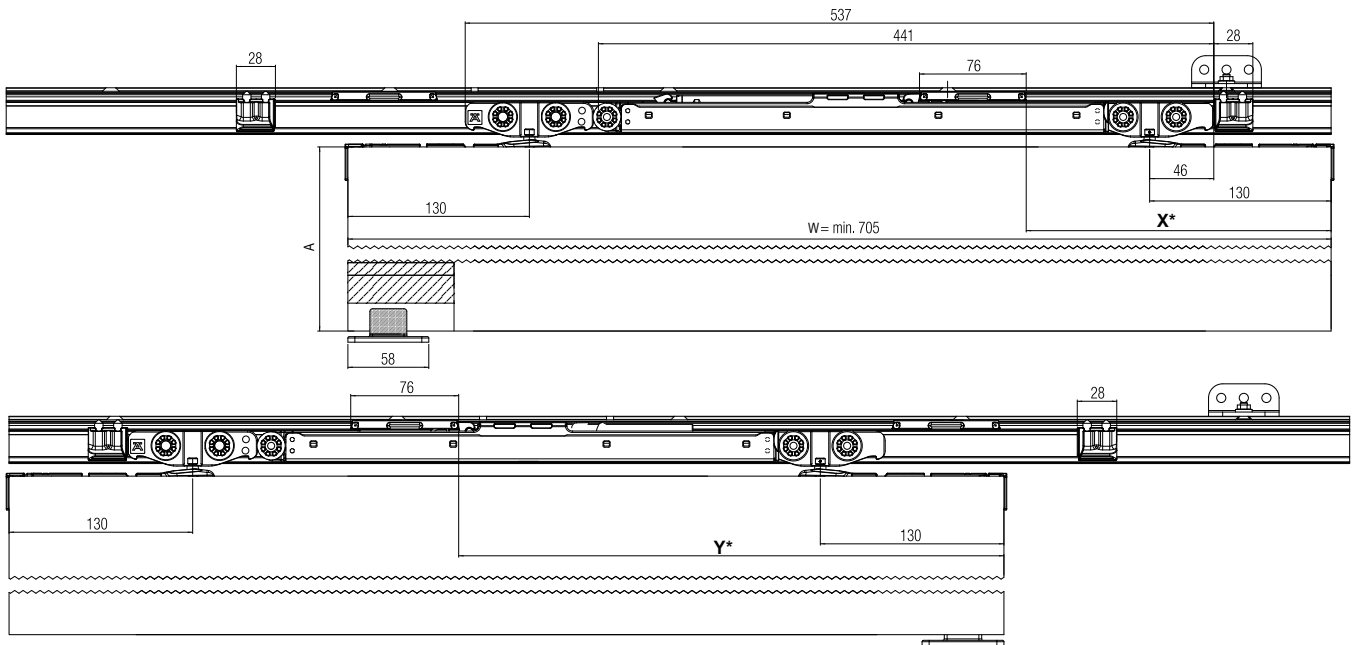

0-100 kg	≥ 100 kg
X* = 218	X* = 203
Y* = 386	Y* = 401

Track Dimension:

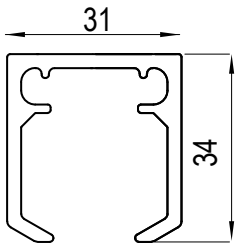

Bottom Guide Cross Section:

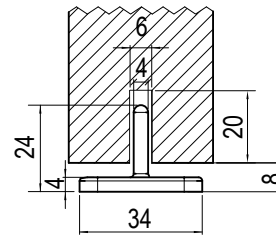

Door Cut-out:

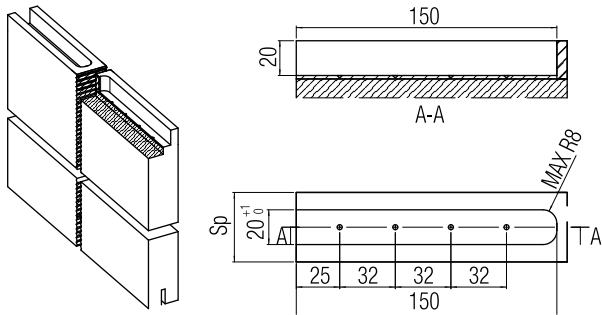

Classic 175

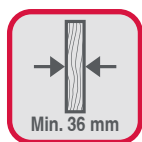
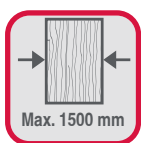

Straight sliding system for wooden doors.

Hardware Specification:

- Solid rollers made of high quality Zamak one piece die casting
- Ground Shielded ball bearing for silent sliding
- Wheel made up of Delrin, special anti wear compound
- High tech hanger made of high quality Zamak alloy with solid structure and discrete design
- Adjustable bottom guide for perfect alignment of the door run
- Height Adjustment 10mm

Note: If you place the order using the individual components (as listed below), please order the track separately. Alternately if you place the order using the BOM Articles (mentioned in the BOM LIST table), the track is included.



Article No.: 941.75.001

Sliding door kit consists of:

- 2 Rollers with Bracket
- 1 Bottom Guide
- 2 Adjustable Stoppers and other fittings

Product Name	Article No.	L mm ← →	
Aluminium anodized top track	941.75.920	2000 mm	
	941.75.930	3000 mm	
	941.75.604	4000 mm	
OPTIONAL			
Product Name	Article No.	Thickness	
Wall mounting bracket	940.66.060	3 mm	

BOM LIST (Track Included)	
Description	Article No.
Classic 175 with track 2 m	940.99.248
Classic 175 with track 3 m	940.99.249
Classic 175 with track 4 m	940.99.250

Section View:
Wall Mounting

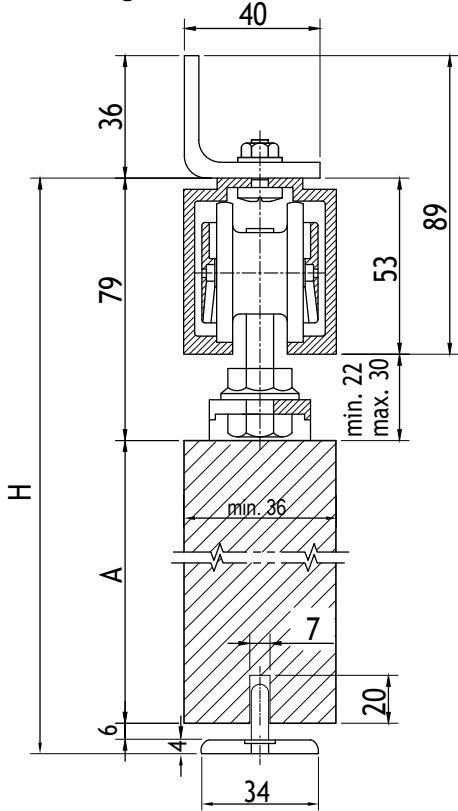

Ceiling Mounting

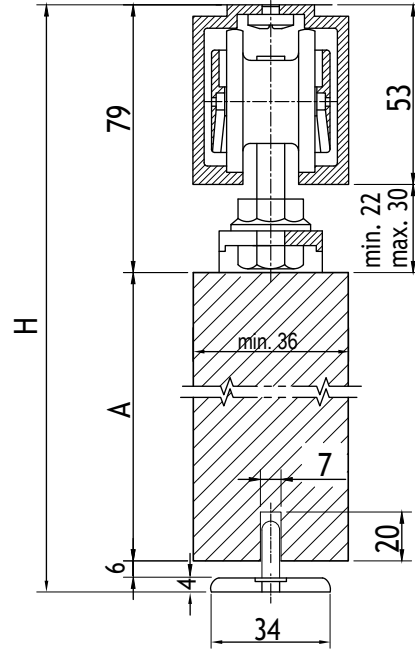

Door Height (A) = Total Height Clearance (H) - [Track Height (Non Concealed) + Desired Gap (Top+ Bottom)]

Elevation View:

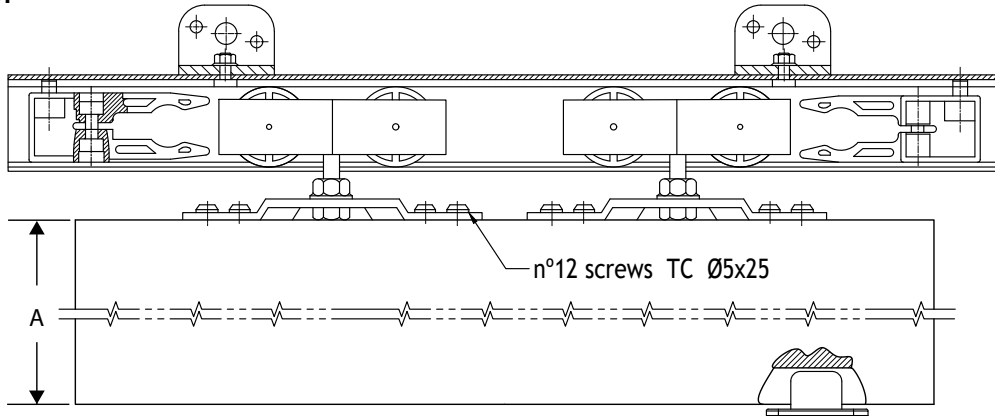

Track Dimension:

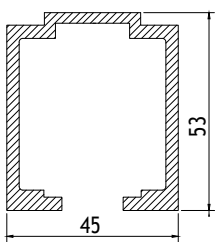

Bottom Guide Cross Section:

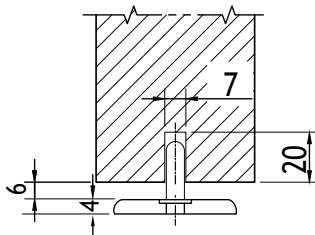

Mounting Bracket:

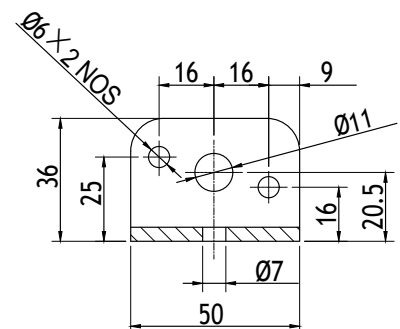

Classic 300 W

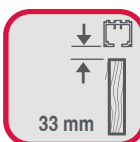
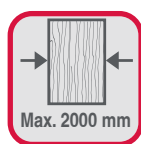
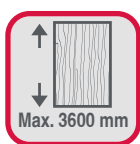

Straight sliding system for wooden doors.

Hardware Specification:

- Rollers with ball bearings fitted on the nylon wheels
- For internal doors up to 300kgs weight
- System with vertical adjustment mechanism
- Optional lower profile with hidden lower pivot

Note: If you place the order using the individual components (as listed below), please order the track separately. Alternately if you place the order using the BOM Articles (mentioned in the BOM LIST table), the track is included.





Article No.: 942.63.009



Sliding door kit consists of:

- 2 Rollers with Bracket
- 1 Bottom Guide
- 2 Adjustable Stoppers and other fittings





Product Name	Article No.	 L mm	
Aluminium anodized top track	943.39.930	3000 mm	
	943.39.945	4500 mm	
Aluminium lower profile (Note: Optional components to be ordered separately) (PC.: 1)	942.63.750	5000 mm	

OPTIONAL			
Product Name	Article No.	Thickness	
Wall mounting bracket	940.66.060	3mm	
Lower pivot	942.63.031		

BOM LIST (Track Included)	
Description	Article No.
Classic 300 W with 3 m track	940.99.251
Classic 300 W with 4.5 m track	940.99.252

Section View:

Wall Mounting:

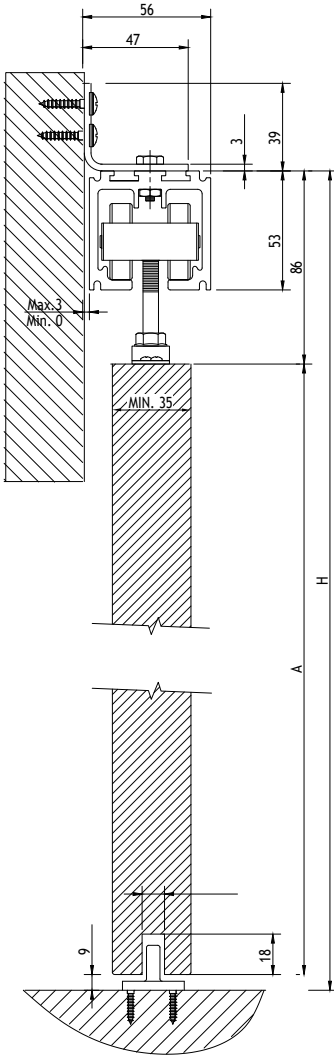

Ceiling Mounting:

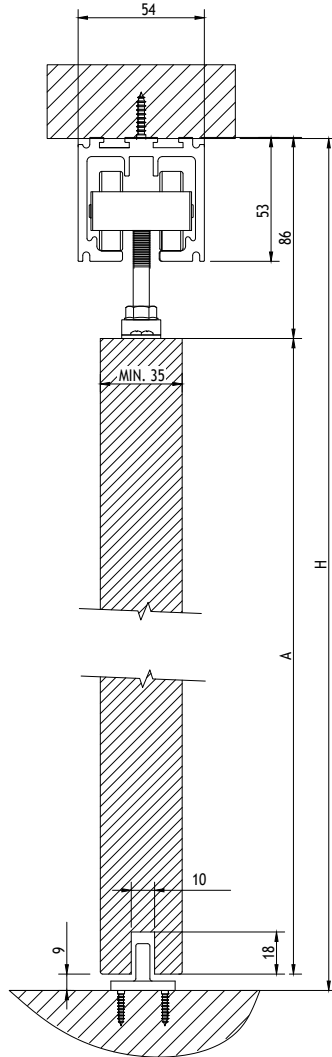

Concealed Mounting:

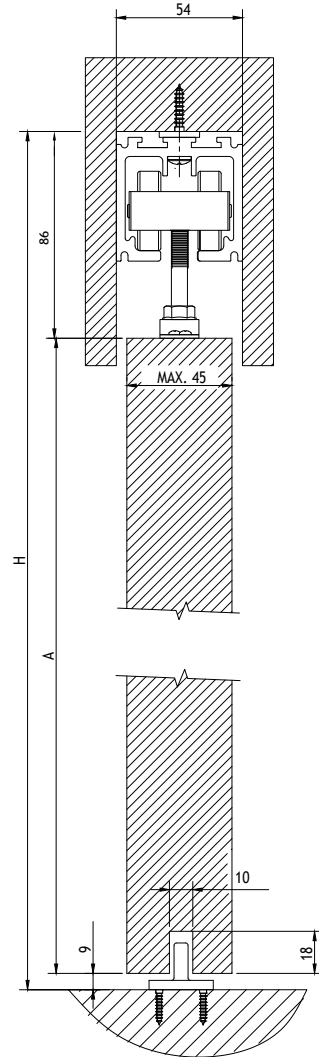

$$\text{Door Height (A)} = \text{Total Height Clearance (H)} - [\text{Track Height (Non Concealed)} + \text{Desired Gap (Top+ Bottom)}]$$

Track Dimension:

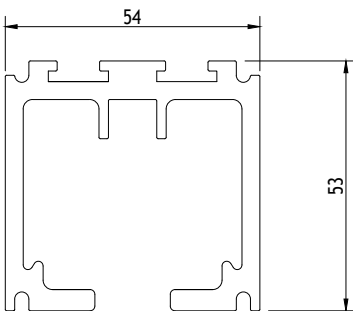

Bottom Guide Cross Section:

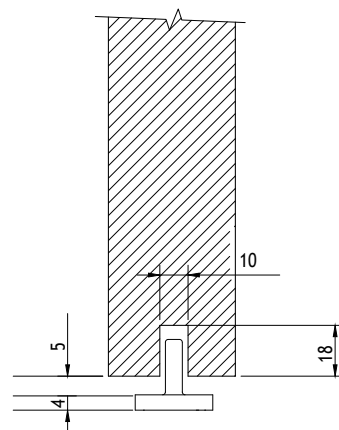

Classic 500

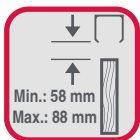
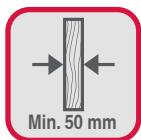
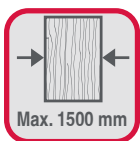
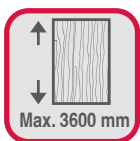
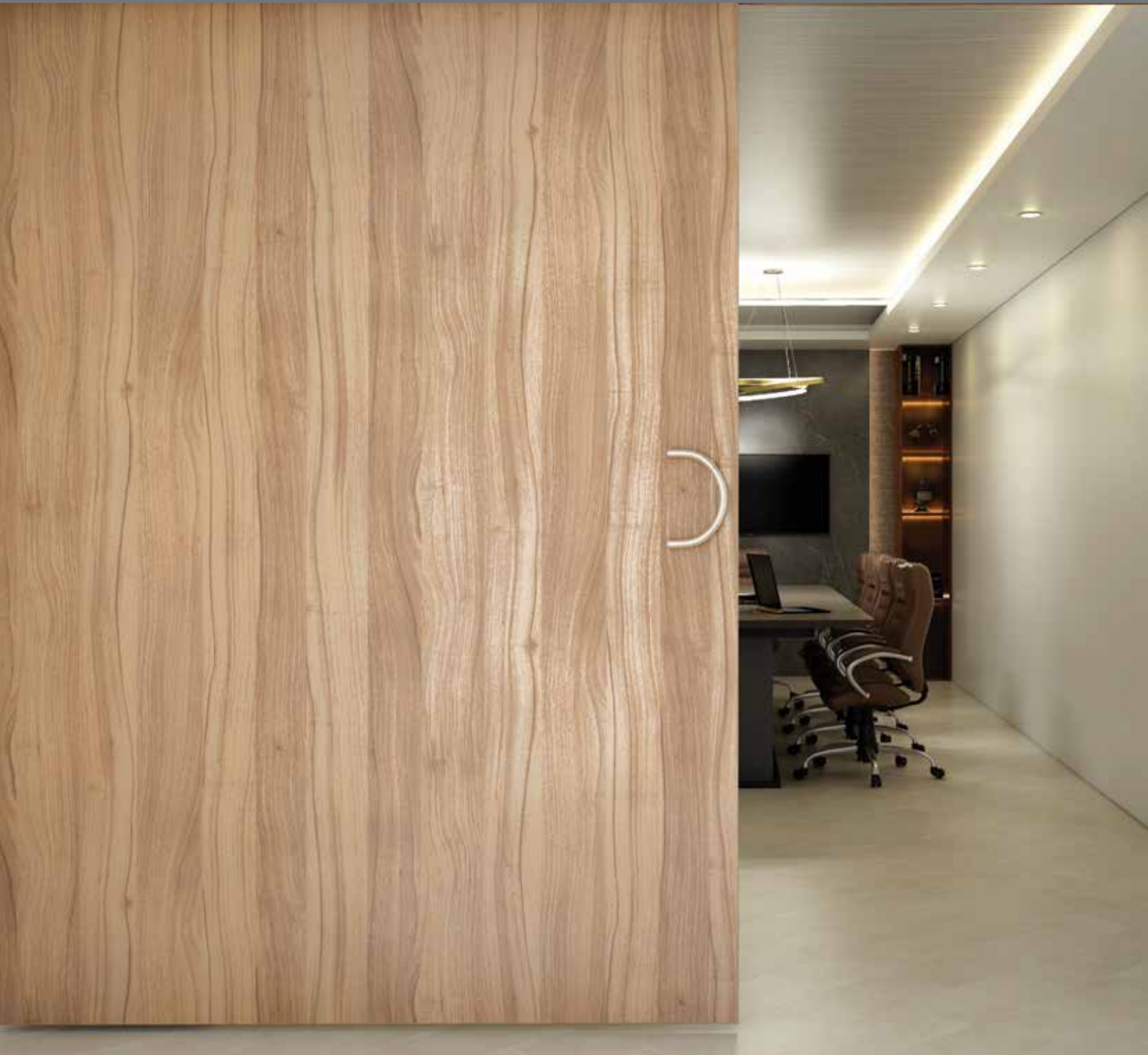









Straight sliding system for wooden doors.

Hardware Specification:



- Rollers with ball bearings fitted on smooth nylon wheels
- For doors up to 500kg weight
- System with vertical adjustment mechanism
- Lower guide with hidden lower pivot

Note: If you place the order using the individual components (as listed below), please order the track separately. Alternately if you place the order using the BOM Articles (mentioned in the BOM LIST table), the track is included.

Product Name	Article No.	Pcs	
Rollers	942.63.012	2	
Adjustment Plate M-16	942.63.092	2	
Adjustment Screw	942.63.091	2	
Stop and Brake	942.63.040	1	
Lower Pivot	942.63.070	1	

Product Name	Article No.	 L mm	
Galvanized top track	942.63.630	3000 mm	
Galvanized bottom track	942.63.550	3000 mm	

OPTIONAL

Product Name	Article No.	Pc.	
Wall mounting bracket	942.63.062	1	
Ceiling bracket	942.63.063	1	

Note: Optional components to be ordered separately

BOM LIST (Track Included)	
Description	Article No.
Classic 500 with 3 m top track without bottom track	940.99.253
Classic 500 with 3 m top track with bottom track	940.99.271

Section View:

Wall Mounting:

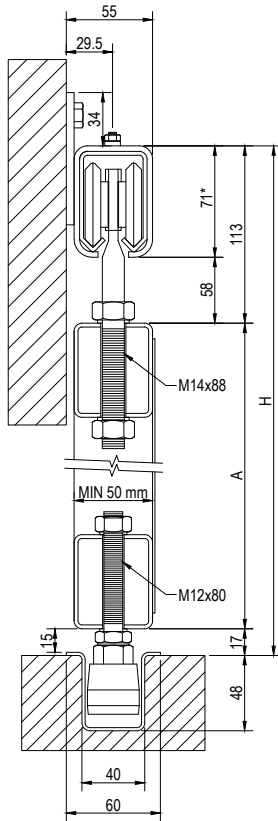

Ceiling Mounting:

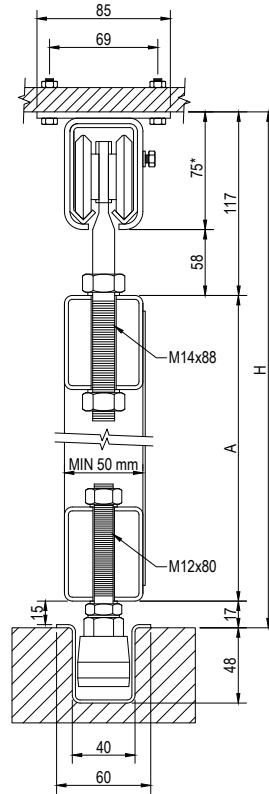

Door Height (A) = Total Height Clearance (H) - [Track Height (Non Concealed) + Desired Gap (Top+ Bottom)]

*Note: Height of the track + Height of the (wall/ceiling) bracket

Elevation View:

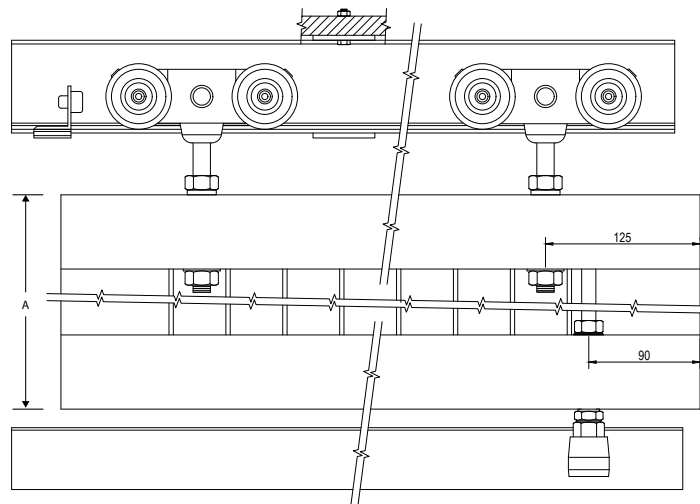

Track Dimension:

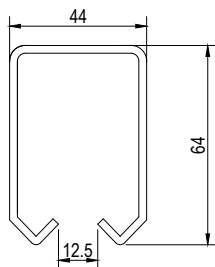

Bottom Track Cross Section:

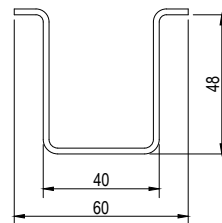



Classic 120 S

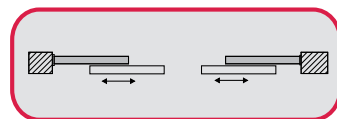
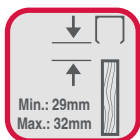
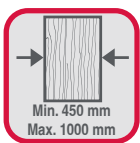

Straight synchro sliding system for wooden doors.

Hardware Specification:

- Synchro system for simultaneous opening of both the doors
- Solid rollers made of high quality Zamak one piece die casting
- High tech hanger made of high quality Zamak alloy with solid structure and discrete design





Article No.: 941.10.035

Sliding door kit consists of:

- 4 Rollers with Bracket
- 2 Bottom Guides
- 2 Pulley Door Profiles
- 2 Cable Brackets
- 8 m Steel Cable
- 2 Stoppers and other fittings



Product Name	Article No.		
Aluminium anodized top track (Note: Track to be ordered separately)	941.10.915	1524 mm	
	941.10.918	1828 mm	
	941.10.921	2134 mm	
	941.10.924	2438 mm	
	941.10.927	2743 mm	
	941.10.930	3048 mm	
	941.10.936	3657 mm	

Section View:

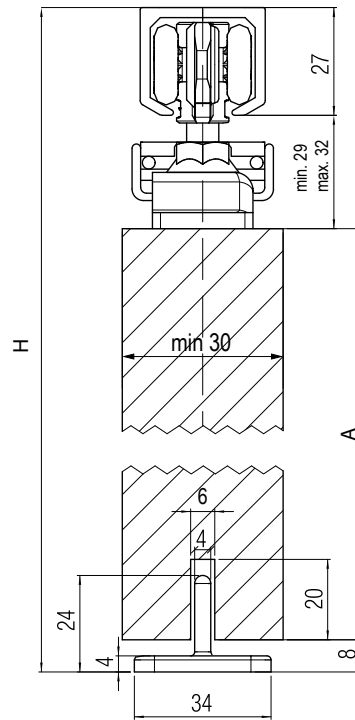

Door Height (A) = Total Height Clearance (H) - [Track Height (Non Concealed) + Desired Gap (Top+ Bottom)]

Elevation View:
Front Elevation

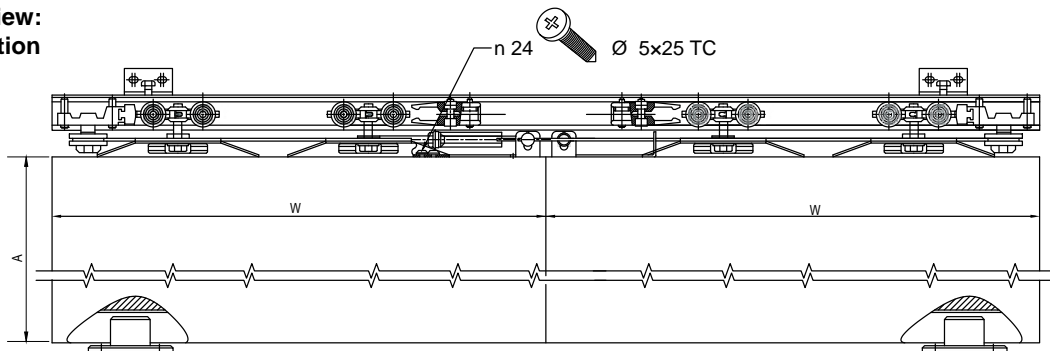

Top Elevation

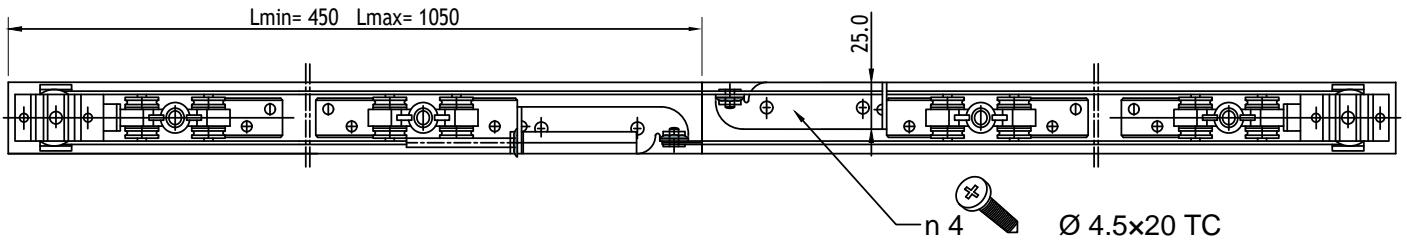

Track Dimension:

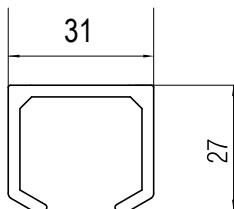

Bottom Guide Cross Section:

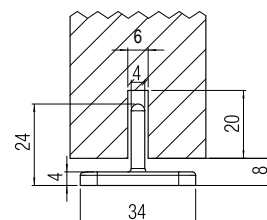



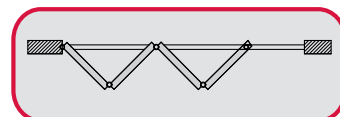
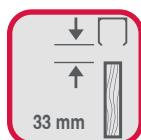
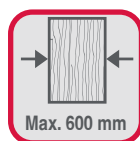
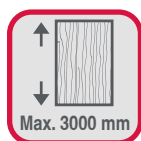

Fold 50 EF T







End fixing sliding folding system for wooden doors.

Hardware Specification:

- Fold 50 EF T is designed for internal doors & room dividers in residential or commercial application with up to 6 panels folding in one direction
- Quiet running action is possible by the use of precision ball bearings and special plastic wheels
- Plastic wheels having higher anti wear performance
- Lower profile with hidden lower pivot
- Lower pivot is allied with a end supporting bracket

System Components	Article No.	Pc.	
Running Gear with M8 Bolt (Pivot Type)	943.17.013	1	
End Support Bracket (Top)	943.17.040	1	
End Support Bracket (Bottom)	943.17.041	1	
Product Name	Article No.	Size	
SS Ball Bearing Butt Hinge for Max. Door Weight 60 kg (3 Hinges Required)	926.32.160	102 X 76 X 3mm	

Product Name	Article No.		
Aluminium anodized top track (Note: Track to be ordered separately)	941.10.915	1524 mm	
	941.10.918	1828 mm	
	941.10.921	2134 mm	
	941.10.924	2438 mm	
	941.10.927	2743 mm	
	941.10.930	3048 mm	
	941.10.936	3657 mm	

Product Name	Article No.		
Aluminium anodized bottom track (Note: Track to be ordered separately)	943.33.720	2000 mm	
	943.33.730	3000 mm	
	943.33.740	4000 mm	

Section View:

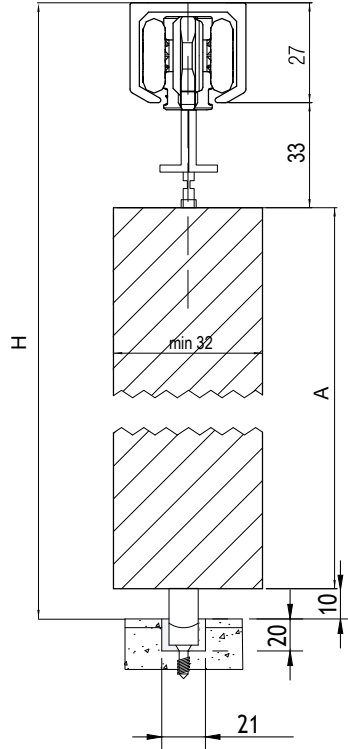

$$\text{Door Height (A)} = \text{Total Height Clearance (H)} - [\text{Track Height (Non Concealed)} + \text{Desired Gap (Top+ Bottom)}]$$

Elevation View:

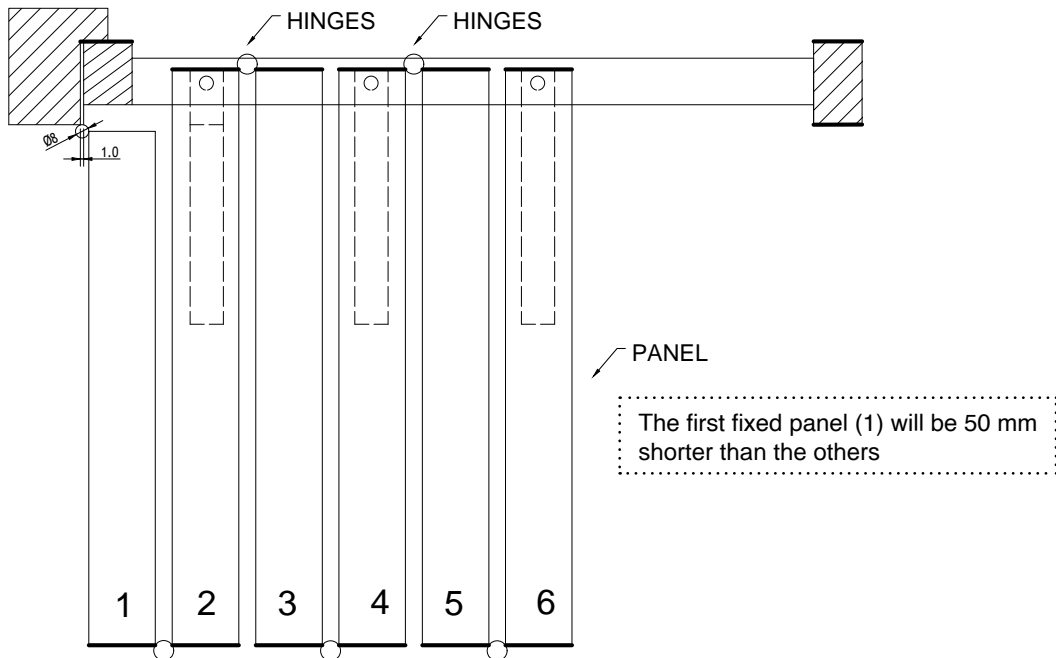

Track Dimension:

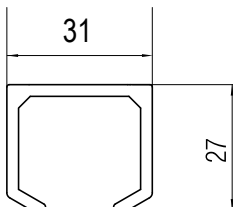

Bottom Track Cross Section:

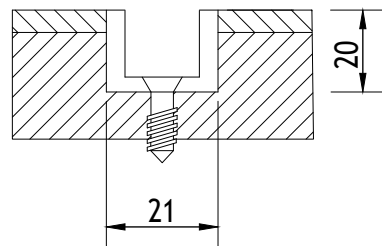

Weatherfold 100 EF

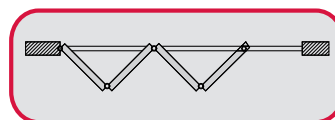
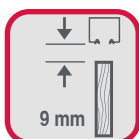
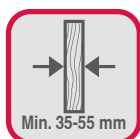
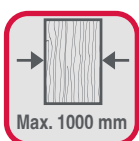
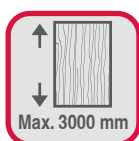



End fixing sliding folding system for wooden doors.

Please use weatherfold calculator for ordering



Hardware Specification:



- For 2 to 16 panels folding door with max. 8 panels folding each side Suitable for 80-100 kg panel
- Full corrosion resistant construction
- 316 marine grade Stainless Steel parts for improved strength and maximum corrosion resistance
- Mortise & non-mortise hinges
- Precision bearing top and bottom to reduce rolling resistance
- New push button system on all pivot sets, intermediate sets and hanger sets



Product Name	Article No.	
Mortised square pivot set	943.34.008	
Mortised square hinge (Pc.)	943.34.162	
Offset hinge mortise (Pc.)	943.34.186	
Hinge handle set	943.34.101	
Offset hinge handle set	943.34.137	
Intermediate hanger set	943.34.076	
End hanger set	943.34.052	



Product Name	Article No.	
Offset hinge (inward opening)	943.34.125	
Mortised square hinge set	943.34.113	

OPTIONAL		
Product Name	Article No.	
Jamb pivot (Note: To be used for height above 2400 mm)	943.34.145	



Product Name	Article No.		
Aluminium anodized top track (Note: Track to be ordered separately)	943.34.920	2000 mm	
	943.34.930	3000 mm	
	943.34.940	4000 mm	
	943.34.950	5000 mm	

Product Name	Article No.		
Aluminium anodized bottom track (Note: Track to be ordered separately)	943.33.720	2000 mm	
	943.33.730	3000 mm	
	943.33.740	4000 mm	

Product Name	Article No.		
Polypropylene bottom track (Note: Track to be ordered separately)	943.33.920	2000 mm	
	943.33.930	3000 mm	
	943.33.940	4000 mm	
Flush handle, Satin finish	901.01.096	-	

Product Name	Article No.		
Poly-support aluminium anodized bottom track (Note: Track to be ordered separately)	943.33.120	2000 mm	
	943.33.130	3000 mm	
	943.33.140	4000 mm	

Product Name	Article No.		
Flush Bolt for Weatherfold Stainless Steel Matt (316) (Note: Slide Flush Bolt to be ordered separately)	911.62.501	150 mm	
	911.62.507	190 mm	
	911.62.519	450 mm	
	911.62.516	450 mm	
	911.62.525	600 mm	
	911.62.769	1000 mm	
Flush Bolt with Offset Bolt, Top Mounting	911.62.522	450 mm	
	911.62.513	190 mm	

WEATHERFOLD SEALS			
Product Name	Article No.	UOM	
Track Seal	950.06.293	Metre	
Frame Seal Brown	950.06.203	Metre	
Door Seal Brown	950.06.213	Metre	

Note: Seals to be ordered separately

Installation:



(Note: Total 8 panels on one side)

Track Dimension:

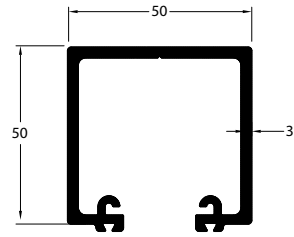

Bottom Track Options:

Option 1

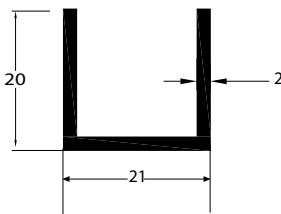

Aluminium Anodised Track

Option 2

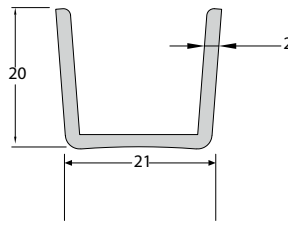

Polypropylene Track

Option 3

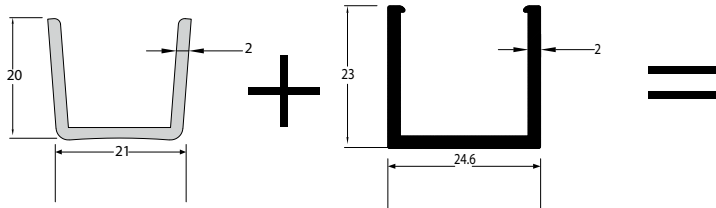

Polypropylene Track

Aluminium Anodised Track

Poly- Support Aluminium Anodised Bottom Track

Jamb Pivot:

Installation

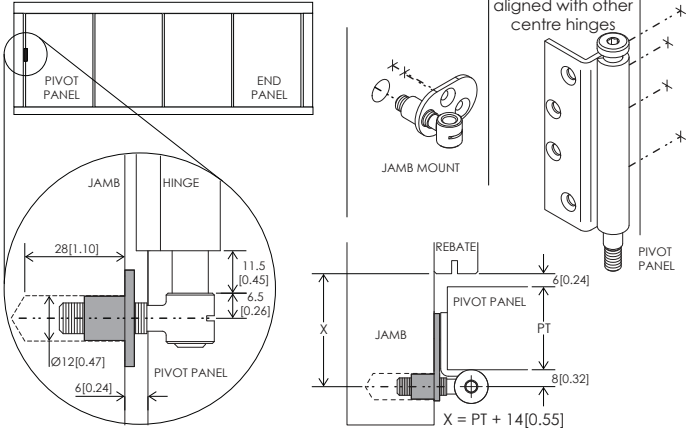

Adjustment

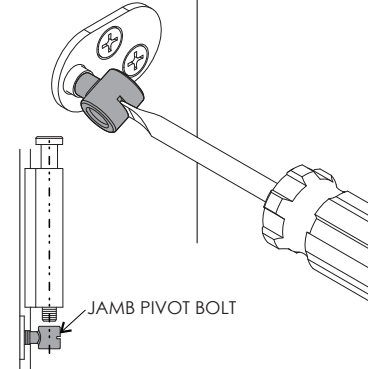

Wind jamb pivot bolt in or out until it aligns with hinge on panel after top and bottom pivot are set

Section View:

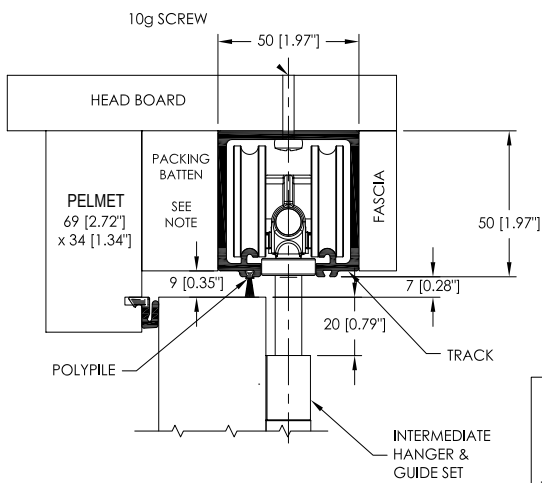

* PACKING BATTEN THICKNESS

100kg TRACK: -
11mm [0.43"] LESS THAN
DOOR THICKNESS

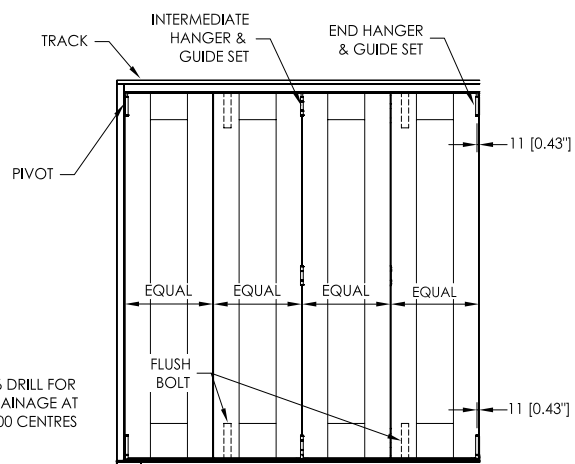
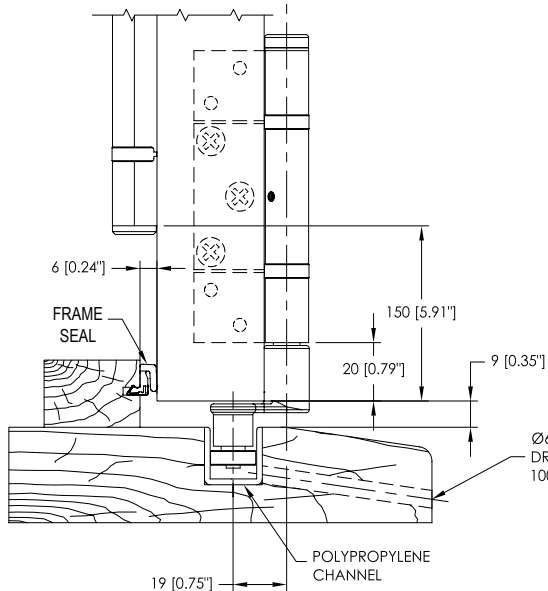
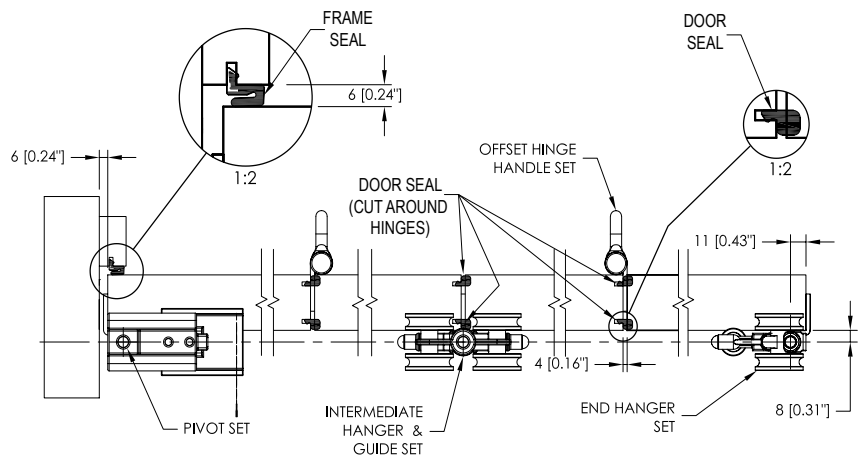
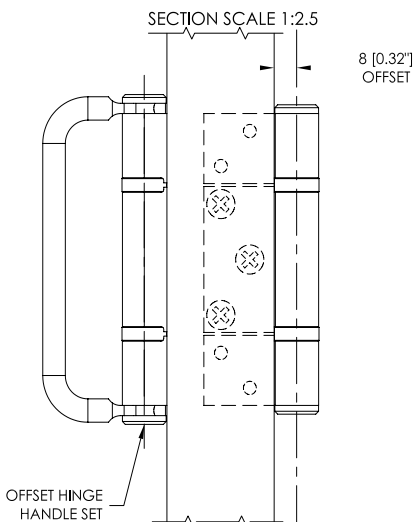
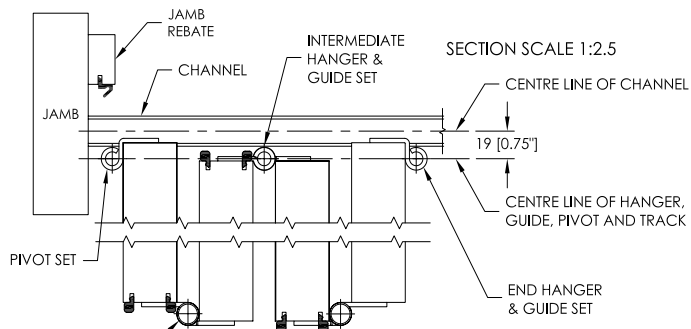

TYPICAL OUTSIDE ELEVATION



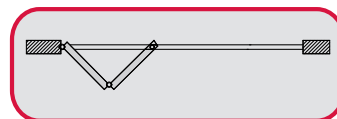
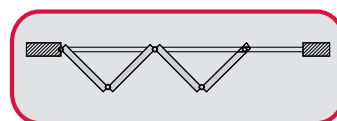
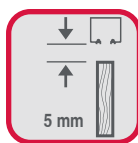
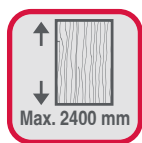





Fold 80 EF

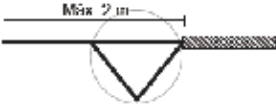

End fixing sliding folding system for wooden doors.

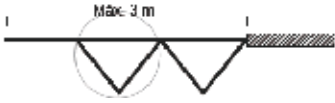
Hardware Specification:

- Top hangers with high quality double rollers ball bearings an elastic action to ensure an exceptionally smooth and quiet sliding folding action
- Breaking plate to hold door(s) in fully closed position

Product Name	Article No.		
Set of accessories for 2 doors	943.03.000		
Set of accessories for additional hinged door	943.03.001		
Set of accessories for 2 additional doors	941.27.439		
Concealed Hinge	927.91.544*		
Aluminium anodized top track (Note: Track to be ordered separately)	940.99.932	3000 mm	
OPTIONAL			
Product Name	Article No.	Size	
SS Ball Bearing Butt Hinge	926.32.160	102 X 76 X 3 mm	

*Note: Max. door weight with 3 hinges (927.91.544): 40 kg
Max. door weight for 3 hinges (926.32.160): 120 kg

Section View:

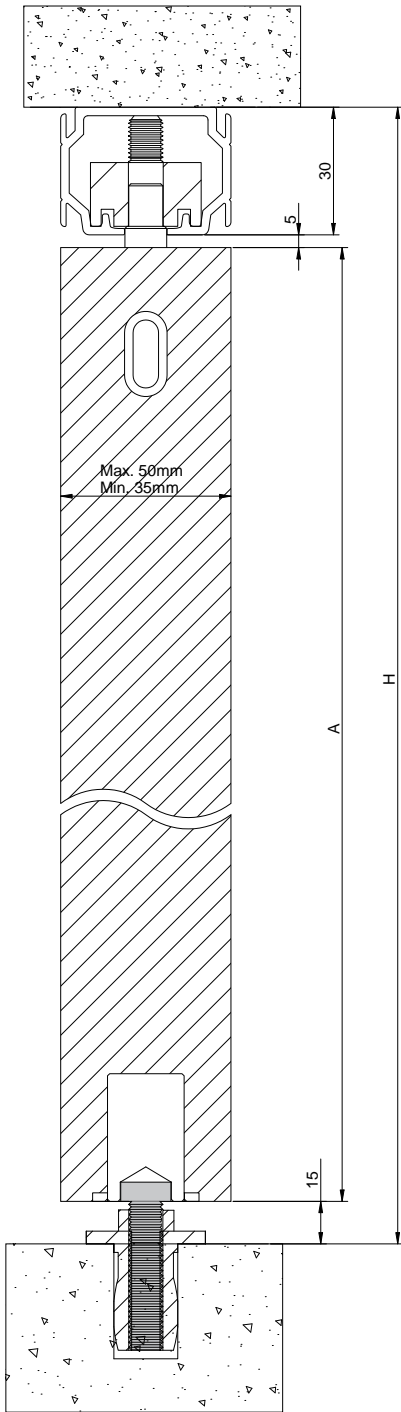

$$A = H - 50$$

Track Dimension:

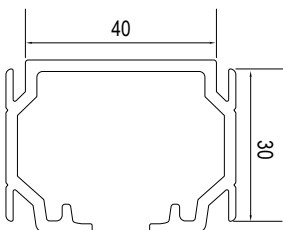

Door Calculation:

For 1 Pair

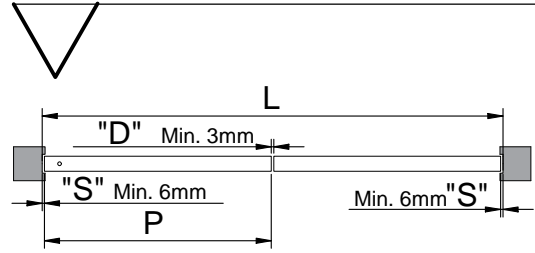

$$P = \frac{L - (2 \times S) - D}{2}$$

For 2 +1 Doors

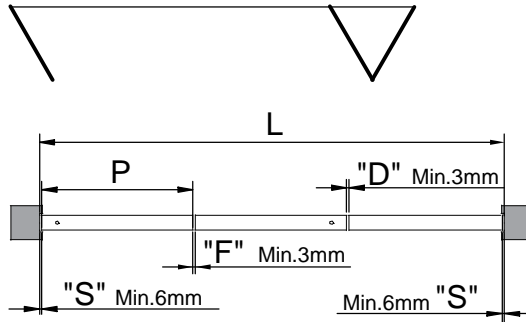

$$P = \frac{L - (2 \times S) - D - F}{3}$$

For 2 Pairs

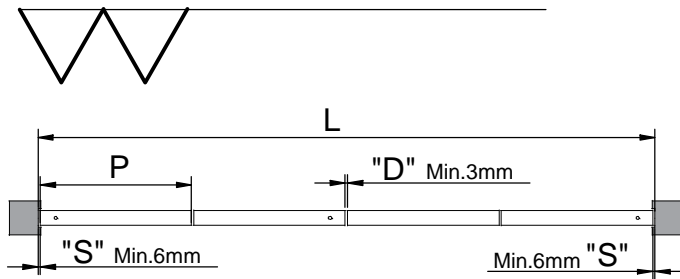

$$P = \frac{L - (2 \times S) - (3 \times D)}{4}$$

35-40	6mm
40-45	7mm
45-50	8mm

- L = Overall width
- P = Leaf width
- F = Central gap
- D = Hinges separation
- C = Door thickness
- S = Minimum gap

Fold 150 CF

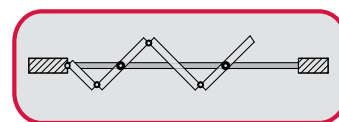
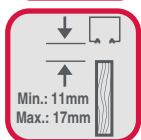
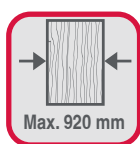
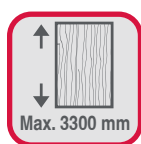

Center fixing sliding folding system for wooden doors.

Hardware Specification:

- Panels are hung centrally under the support and can fold to one or both sides of the opening
- Hangers are fitted with nylon tier wheels on ball race bearings
- Easy vertical adjustment
- Guide incorporates a precision bearing
- Folding door with max. 6 panels folding each side suitable for max. 75 kgs per panel

Sliding System Components	Article No.	Pcs.	
Hanger	943.34.441	1	
Ball Bearing Butt Hinges	926.32.160	1	
Flush Handle	902.01.422	1	
Bottom Guide	943.34.442	1	

*Note: Max. door weight for 3 hinges (926.32.160): 120 kg

OPTIONAL			
Product Name	Article No.	L mm	
Slide Flush Bolt Stainless Steel Matt (304) (Note: Slide Flush Bolt to be ordered separately)	911.62.670	190 mm	
	911.62.671	450 mm	
	911.62.672	600 mm	

SEALS			
Product Name	Article No.		
Track Seal	950.06.293		
Frame Seal Brown	950.06.203		

Note: Seals to be ordered separately

Product Name	Article No.	L mm		Product Name	Article No.	L mm	
Aluminium anodized top track (Note: Track to be ordered separately)	943.34.920	2000 mm		Aluminium anodized bottom track (Note: Track to be ordered separately)	943.33.720	2000 mm	
	943.34.930	3000 mm			943.33.730	3000 mm	
	943.34.940	4000 mm			943.33.740	4000 mm	
	943.34.950	5000 mm					

Section View:

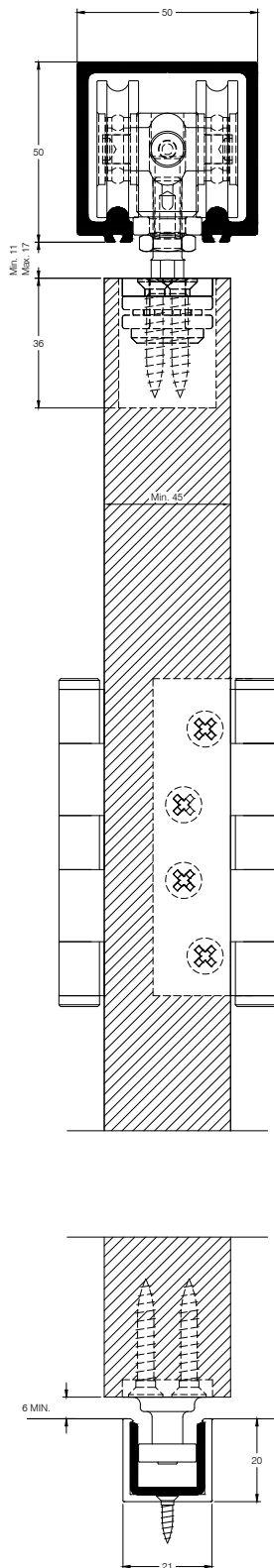

Elevation View:

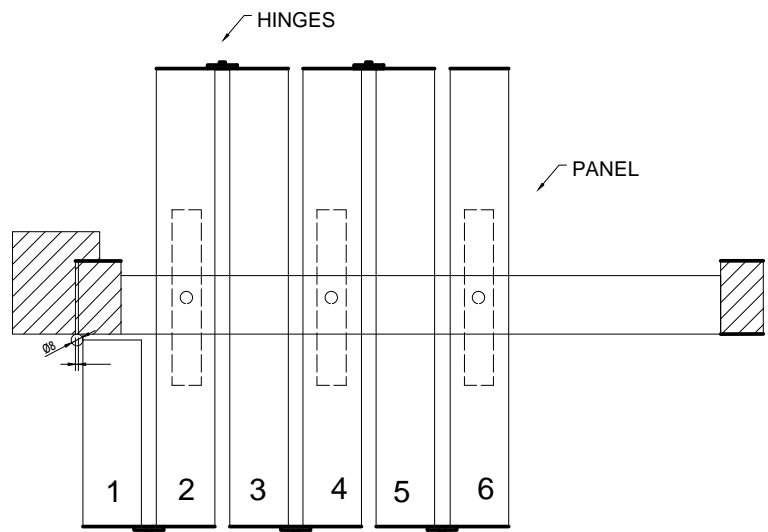

Track Dimension:

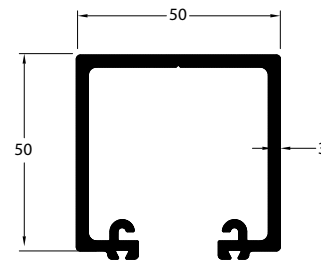

Bottom Track Cross Section:

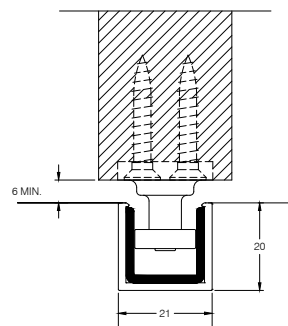

Door Height (A) = Total Height Clearance (H) - [Track Height (Non Concealed) + Desired Gap (Top+ Bottom)]

FORMULA FOR PANEL WIDTH CALCULATIONS

FULL PANEL WIDTH	$= \frac{\text{WIDTH BETWEEN POSTS}}{\text{NUMBER OF PANELS}} + \frac{1}{2} \text{ PANEL THICKNESS}$
PANEL HINGED TO A POST	$= \left(\frac{1}{2} \text{ FULL PANEL WIDTH} - \frac{1}{2} \text{ PANEL THICKNESS} \right)$
SUBTRACT GAP CLEARANCE FROM FULL PANEL AND HALF PANEL	

FOR EXAMPLE:
 1 UNITS OF 3 1/2 PANELS
 PANEL THICKNESS = 50 MM
 1 PANELS HINGED
 DISTANCE BETWEEN POSTS = 3000
 GAP 4MM CLEARANCE

FULL PANEL WIDTH = $(3000 + 25) / (3.5) = 864.28$ MM
 PANEL WIDTH HINGED TO POST = $(864.28 / 2) - (50 / 2) = 407.14$ MM
 GAP SUBTRACT AS PER THE CLEARANCE
 FULL PANEL WITH CLEARANCE = $864.28 - 4 = 860.28$ MM
 HALF PANEL WITH CLEARANCE = $407.14 - 4 = 403.14$ MM

NEW Classic 80 M

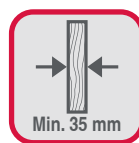
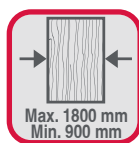
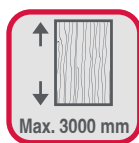

Straight sliding system for wooden doors.

Hardware Specification:

- Patented product that guarantees functionality and aesthetical renovation
- Track and sliding gear are completely concealed - all you can see is the clean, flush door fronts
- Advanced operational technology yet easy to install
- High quality system components guarantee durability and operational functionality
- Come with breaking dampers for smooth and soft opening and closing of the doors



Article No.: 940.59.009

Sliding door kit consists of:

- Top Track
- Housing for Bottom Running Gear
- Bottom Track
- Bottom Running Gear
- Fixing brackets for Top Gear
- Top Running Gear
- Cover Caps for Top Track
- Damping mechanism for Top Track
- Flush Handles
- Distance Spacers
- Allen Key and Fixing Screws
- Bottom Guide

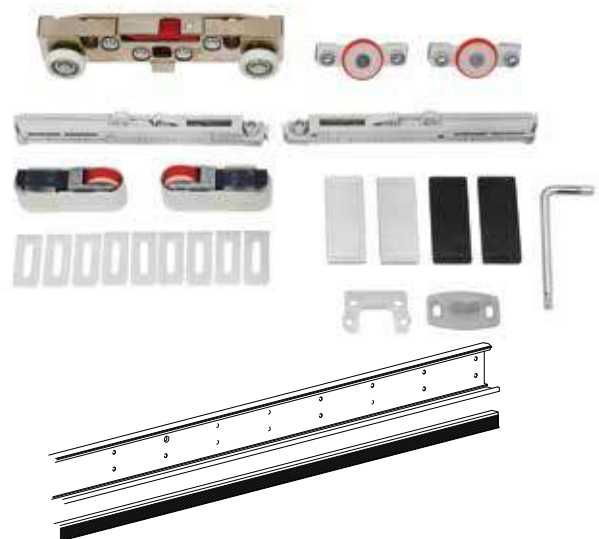

Door Cut-out:

Option 1
STANDARD MILLED

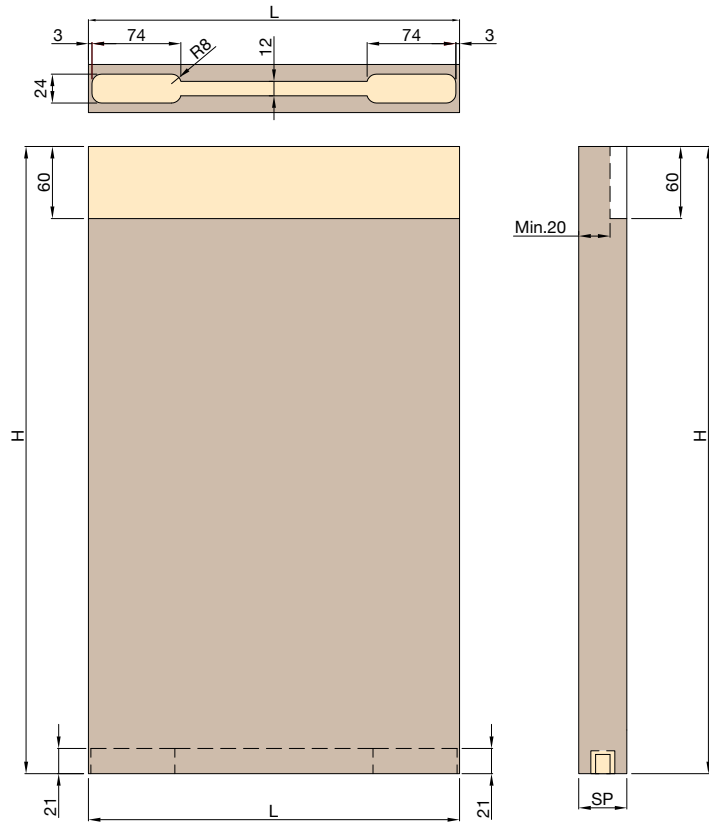

Option 2
HIDDEN MILLED

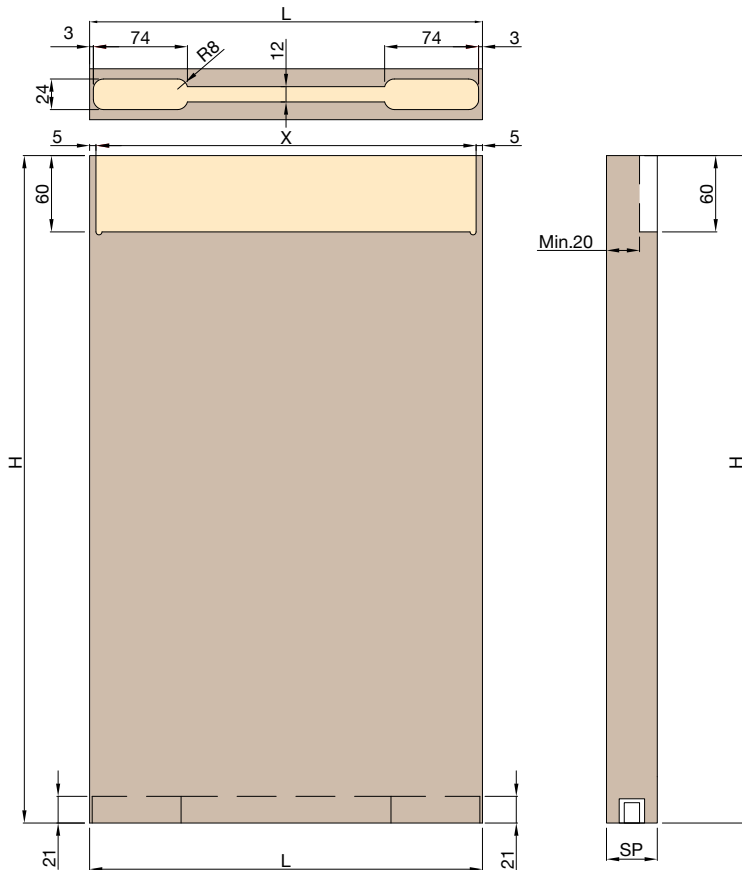

Section View:
Description of measures

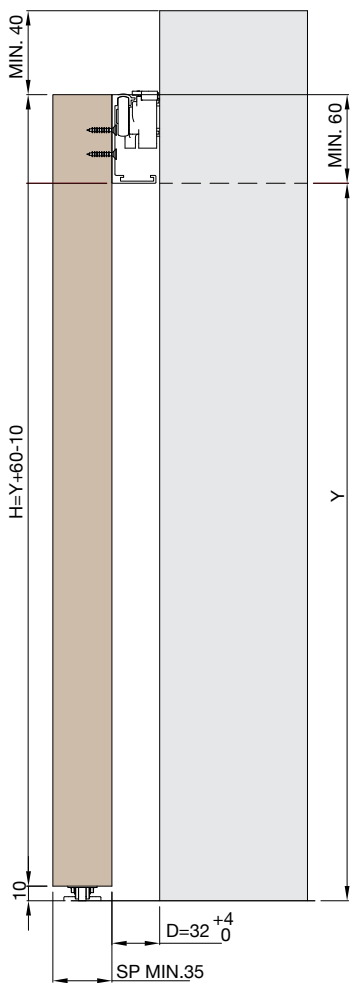

**Hidden track installation
directly onto the sliding
panel**

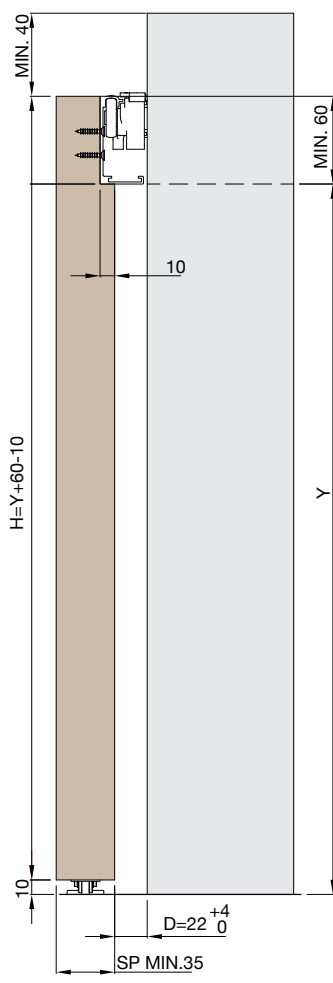

**Hidden track installed
in the 10 mm groove of the
sliding panel**

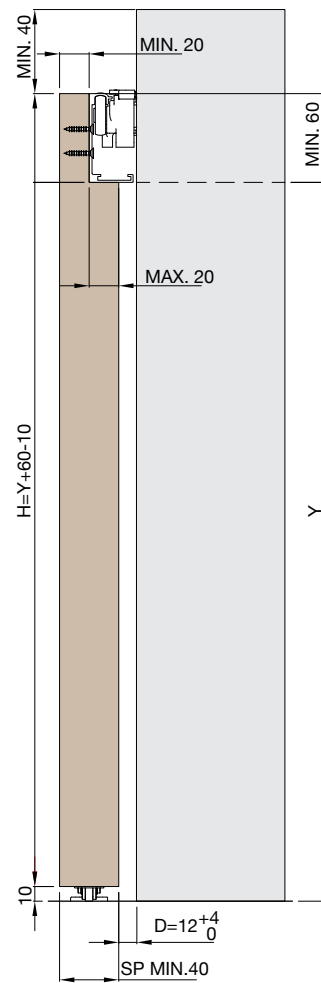

**Hidden track installed
in the 10 - 20 mm groove of
the sliding panel**

H = Door Height
Y = Opening Clearance (Height)

Standard Position

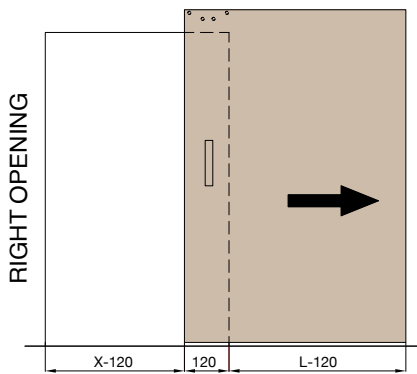
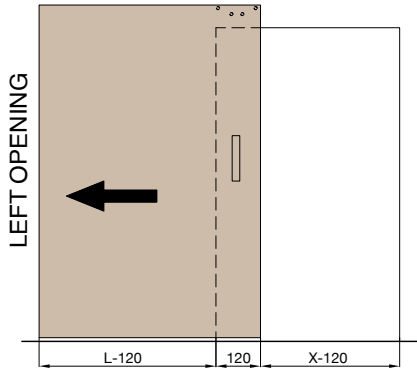

B = 0 mm (Min.)
B = 50 mm (Suggested)

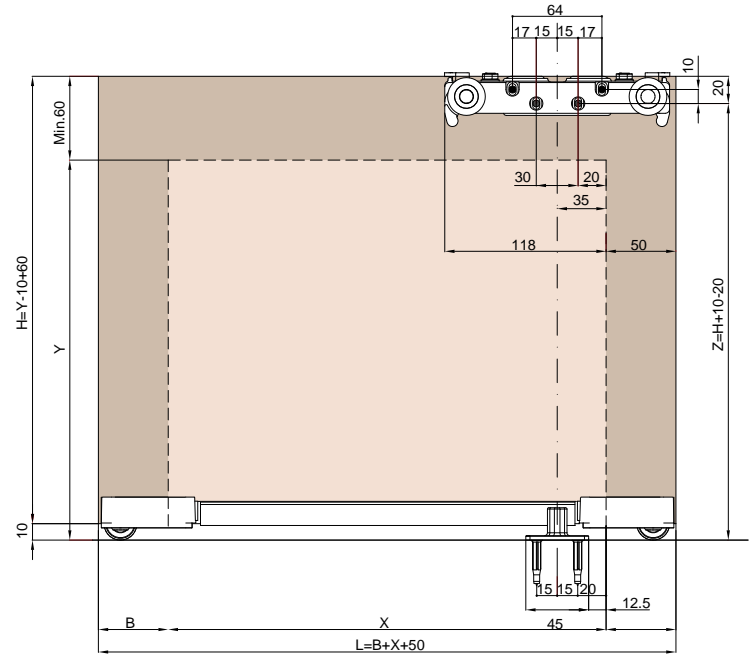

B=0
X= MIN. 800 (L=850) / X= MAX. 1750 (L=1800)

B=50
X= MIN. 800 (L=900) / X= MAX. 1700 (L=1800)

Intermediate Position

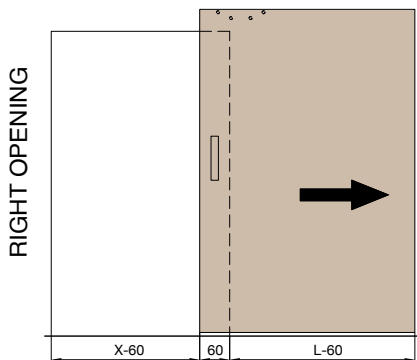
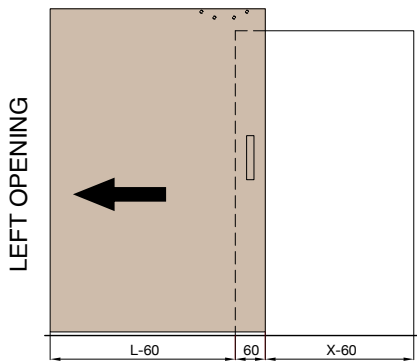

B = 0 mm (Min.)
B = 50 mm (Suggested)

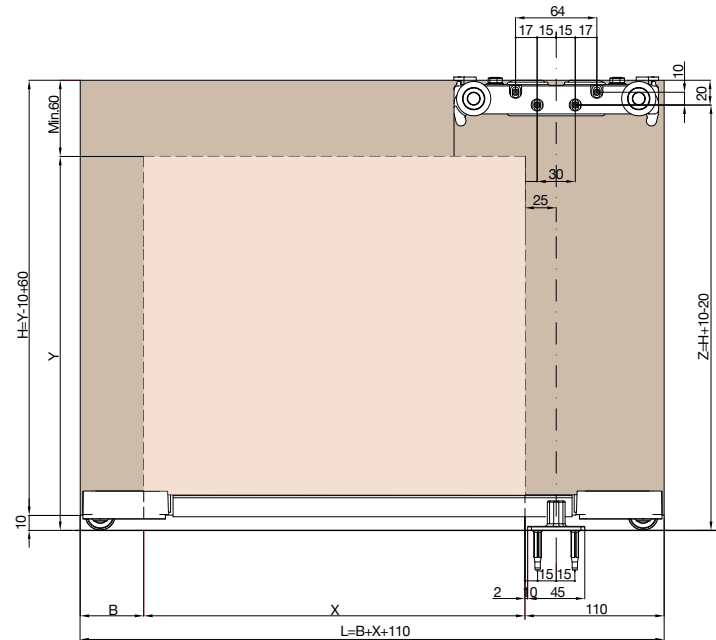

B=0
X= MIN. 740 (L=850) / X= MAX. 1690 (L=1800)

B=50
X= MIN. 740 (L=900) / X= MAX. 1640 (L=1800)

Total Opening Position

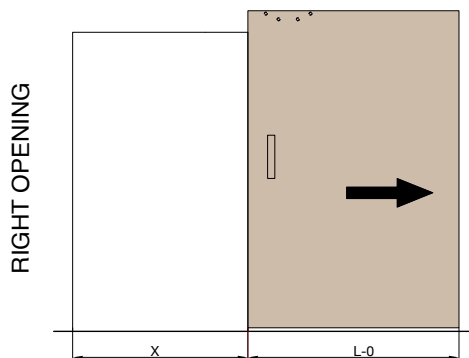
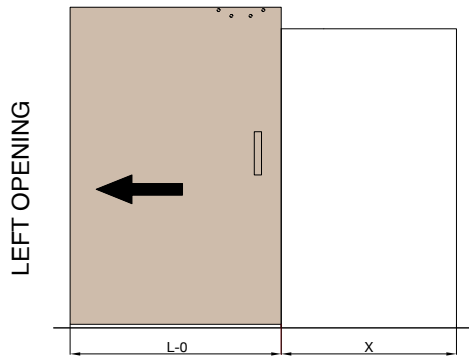

B = 0 mm (Min.)
B = 50 mm (Suggested)

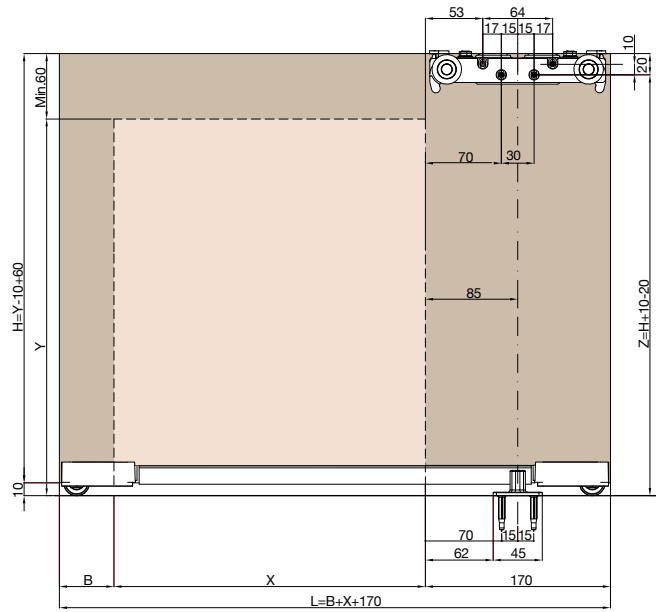

B=0
X= MIN. 680 (L=850) / X= MAX. 1630 (L=1800)

B=50
X= MIN. 680 (L=900) / X= MAX. 1580 (L=1800)

Classic Telescopic Progressive 80

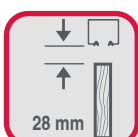
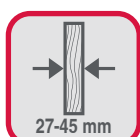
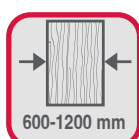
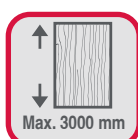

Telescopic progressive sliding system for wooden doors

Hardware Specification:

- Top hung straight sliding system for wooden doors in internal spaces
- High quality parts and components manufactured in Europe
- Maximum 3 doors on one side are allowed
- When one door is pushed or pulled, the other doors move simultaneously in tandem
- The floating bottom guides are installed on the sliding doors keeping them hidden when the doors are parked. This leaves a completely free passage
- The roller and hanger are made of Zamak which reduces the risk of rusting and damage
- Ground shielded ball bearings inside the rollers enable silent and smooth operation
- Roller wheels are made of DELRIN – a special anti-wear compound that offers higher tensile strength, stiffness and impact resistance
- Mechanism is available for both left hand and right hand doors



Kit for two doors - **941.27.002**
Sliding door kit consists of:



- 4 Rollers
- 4 Bracket set
- 4 Stoppers
- 1 Fixed Bottom Guide
- 1 Floating Bottom Guide
- 2 Pulley
- 1 Belt
- 1 Supporting Brackets and accessories



Kit for three doors - **941.27.003**
Sliding door kit consists of:

- 6 Rollers
- 6 Bracket set
- 6 Stoppers
- 1 Fixed Bottom Guide
- 2 Floating Bottom Guides
- 4 Pulleys
- 2 Belts
- 1 Supporting Bracket and accessories



Product Name	Article No.		
Aluminium anodized top track (Note: Track to be ordered separately)	940.99.604	3600 mm	

THE MOVEMENT OF THE DOORS
Classic 80 Telescopic Progressive

Three Doors

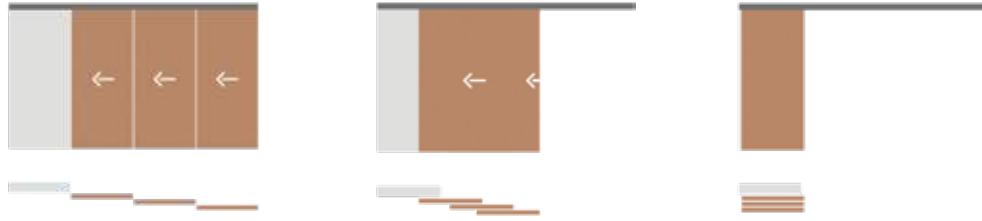

Two Doors

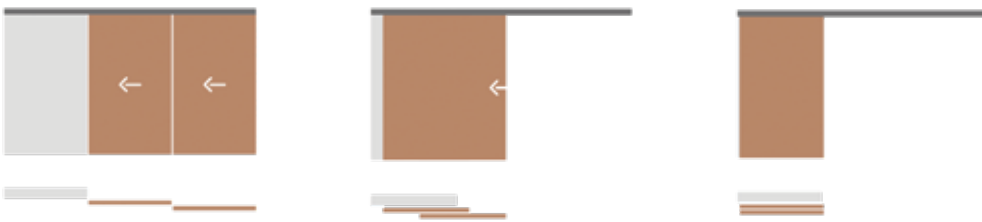

INSTALLATION POSSIBILITIES FOR TELESCOPIC PROGRESSIVE SYSTEMS

For Two Doors

Levelled System

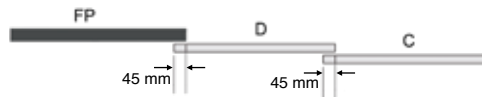

Overlap System

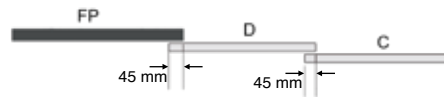

For Three Doors

Levelled System

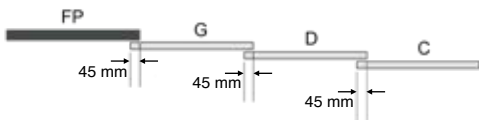

Overlap System

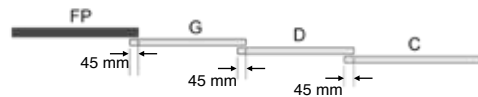

Note 1: The fixed panel can be wood or glass for both the Telescopic Progressive systems. The overlap system is useful when you want to install handles on both the sides of the exterior door

Installation

Classic 80 Telescopic Progressive

A = Height of Sliding Door; H = Total Opening Height

For Two Doors
Section View:

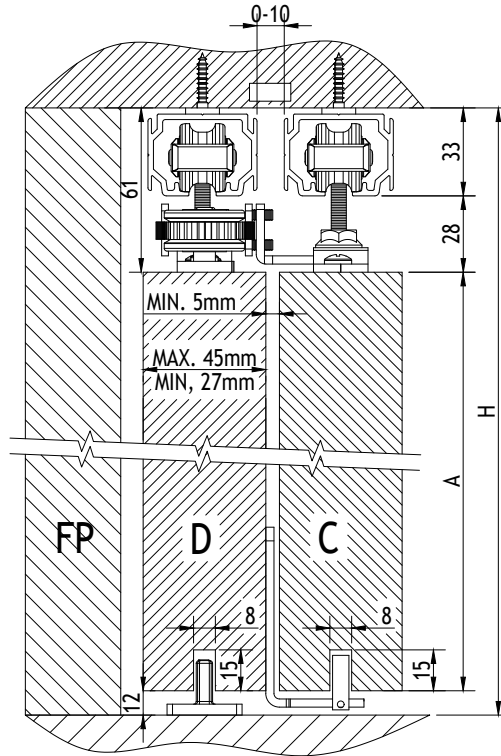

$A = H - 73$

LEFT

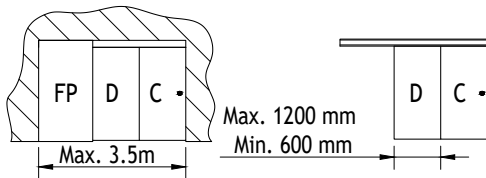

RIGHT

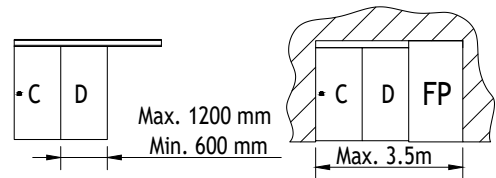

Leveled

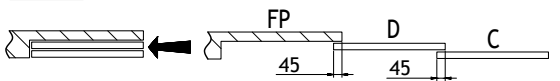

Leveled

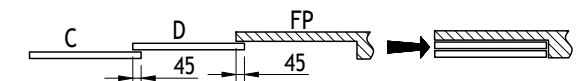

Overlap

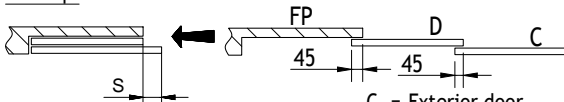

Overlap

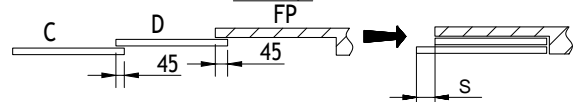

C = Exterior door
D = Interior door
FP = Fixed sheet
S = Overlap width of exterior door

Track Dimension:

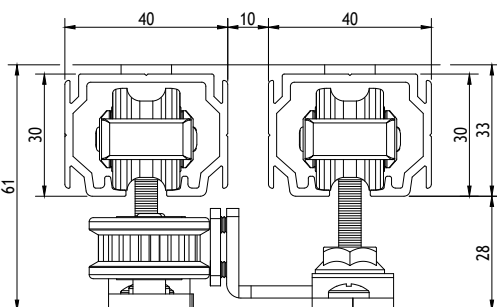

Bottom Guide Cross Section:

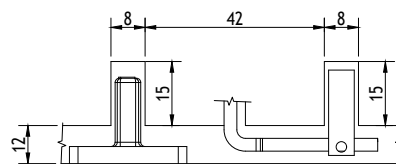

For Three Doors

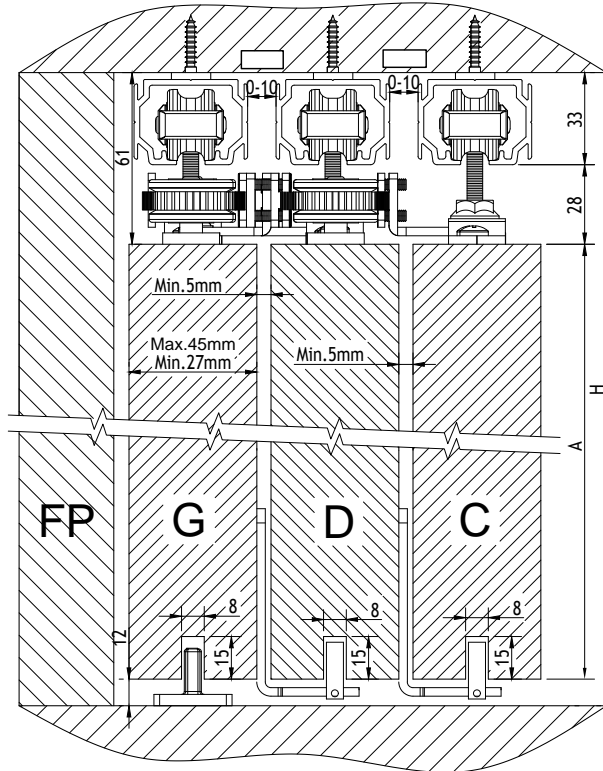

$A = H - 73$

LEFT

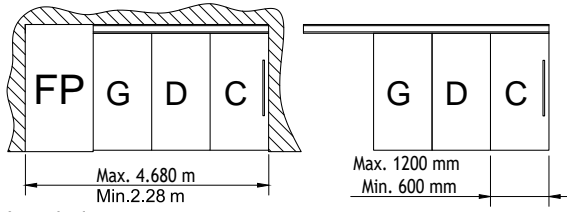

Leveled

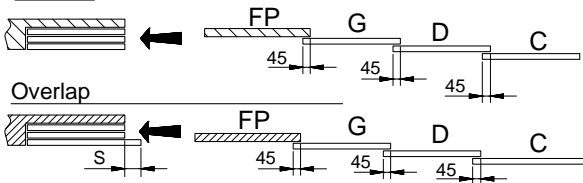

C = Exterior door
D = Central door

RIGHT

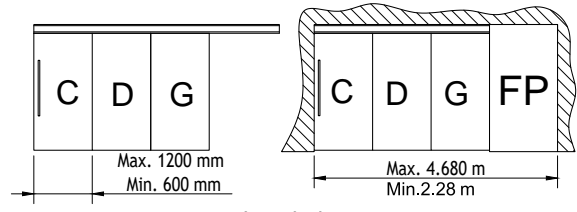

Leveled

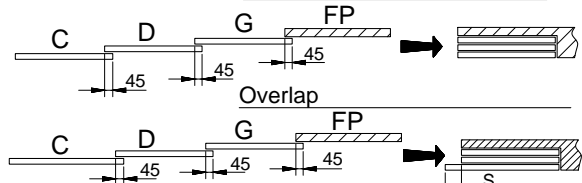

G = Interior door
FP = Fixed sheet
S = Overlap width of exterior door

Track Dimension:

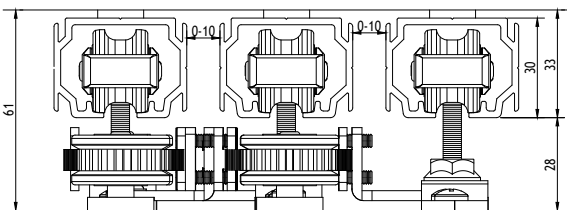

Bottom Guide Cross Section:

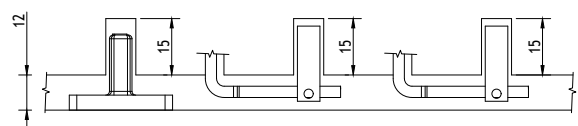





Special Order

Insect Screen

To protect from annoying insects and harmful UV Rays
Highest quality European PVC-coated retractable pleated polyester mesh with water resistance.



Insect Screen

Features:



- The screen is fitted with high strength tension cords made from Vectran® braids which run horizontally across the opening to:
 - Provide stability to the screen.
 - Control the vertical orientation of the handle bar.
 - Help prevent the mesh from blowing out of its channels in windy conditions.
- Wind test withstanding wind gusts up to 30kph.
- The mesh has a 20mm wide pleat set at an angle of 45 degrees which adds stability to the screen making it inherently more stable to sag than flat mesh roller screens.
- Low operating force that slides to any position along the opening.
- Up to 10 stainless steel precision bearings on all wear points are used.
- Designed to be easily integrated into the joinery frame.
- Only 30mm deep channel.
- Designed & Assembled in Australia.
- Patent protected cassette adjustment system.
- Tested to over 150,000 cycles.
- 5 Year Limited Warranty.
- Quality Control.



Offers to be based on the jamb to jamb opening and the height of the opening.

HAFELE INSECT SCREEN SELECTION CHART

		Width Range			
		900-1100	1100-1500	1500-2000	
Min - Max mm	KIT	Article No.	Article No.	Article No.	
Height Range	3000 - 3200	Screen Kit	976.02.414	976.02.415	976.02.416
	2800 - 3000	Screen Kit	976.02.412	976.02.413	976.02.380
	2600-2800	Screen Kit	976.02.409	976.02.410	976.02.411
	2400-2600	Screen Kit	976.02.406	976.02.374	976.02.375
	2200-2400	Screen Kit	976.02.404	976.02.370	976.02.405
	2000-2200	Screen Kit	976.02.364	976.02.365	976.02.366
	1800-2000	Screen Kit	976.02.400	976.02.401	976.02.362
	1600-1800	Screen Kit	976.02.360	976.02.397	976.02.361
	1400-1600	Screen Kit	976.02.395	976.02.358	976.02.353
	1200-1400	Screen Kit	976.02.357	976.02.392	976.02.393
	1000-1200	Screen Kit	976.02.355	976.02.356	976.02.390
	800-1000	Screen Kit	976.02.387	976.02.388	976.02.389
600-800	Screen Kit	976.02.354	976.02.385	976.02.386	

Performance

Insect Screen uses only the finest quality materials including European Polyester Mesh. Tensioning cords run horizontally over multiple precision bearings. The tensioning cords provide stability to the screen and control the vertical orientation of the handle bar. The precision bearings significantly increase the life of the screen and keep operating force very low, enabling effortless opening and closing.

		Width Range			
		2000-2700	2700 - 3600	3600 - 4500	
Min - Max mm	KIT	Article No.	Article No.	Article No.	
Height Range	3000 - 3200	Screen Kit	976.02.352	976.02.417	976.02.384
	2800 - 3000	Screen Kit	976.02.381	976.02.382	976.02.383
	2600-2800	Screen Kit	976.02.377	976.02.378	976.02.379
	2400-2600	Screen Kit	976.02.376	976.02.407	976.02.408
	2200-2400	Screen Kit	976.02.371	976.02.372	976.02.373
	2000-2200	Screen Kit	976.02.367	976.02.368	976.02.369
	1800-2000	Screen Kit	976.02.363	976.02.402	976.02.403
	1600-1800	Screen Kit	976.02.398	976.02.399	
	1400-1600	Screen Kit	976.02.359	976.02.396	
	1200-1400	Screen Kit	976.02.394		
	1000-1200	Screen Kit	976.02.391		
	800-1000	Screen Kit			
600-800	Screen Kit				

Postless Corner Application

Now here is a feature that we know many Specifiers appreciate. Insect Screen can screen corner openings without the need for a corner post, providing stunning uninterrupted views.



Section View:

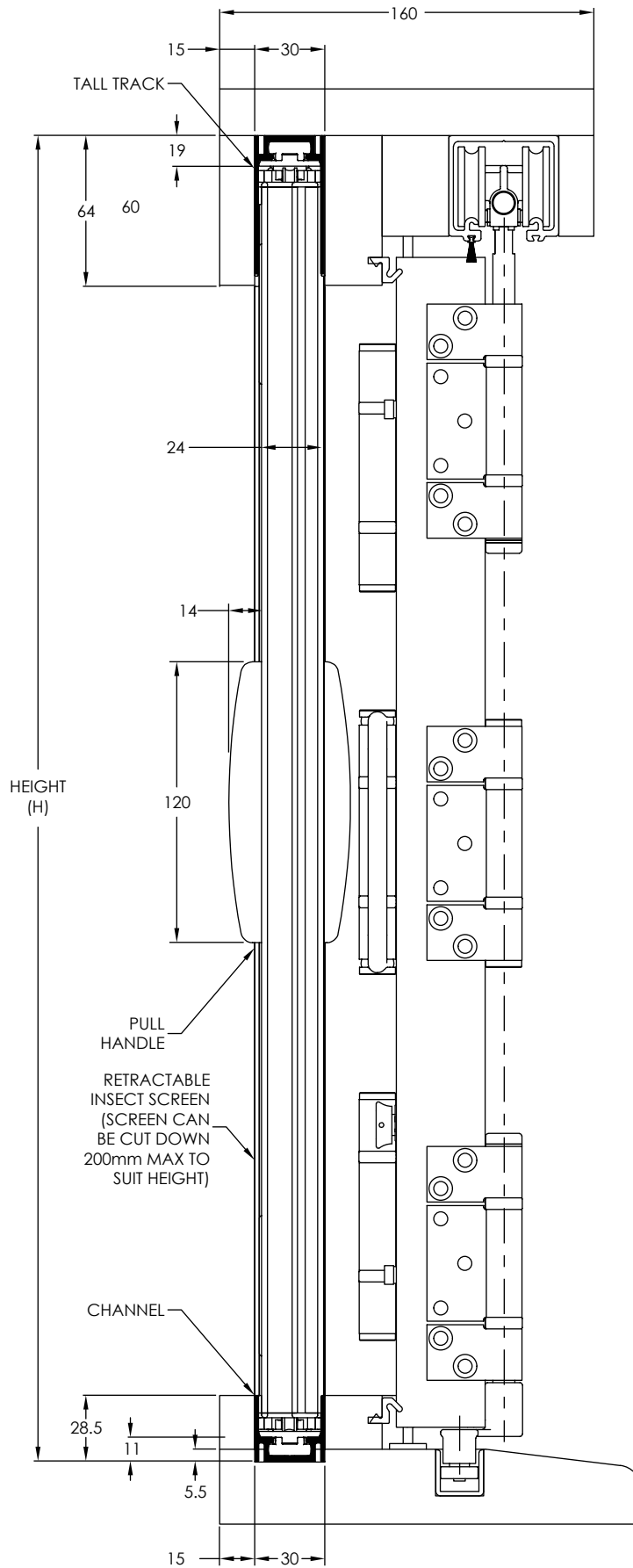



ARCHITECTURAL GLASS DOOR SLIDING SYSTEMS

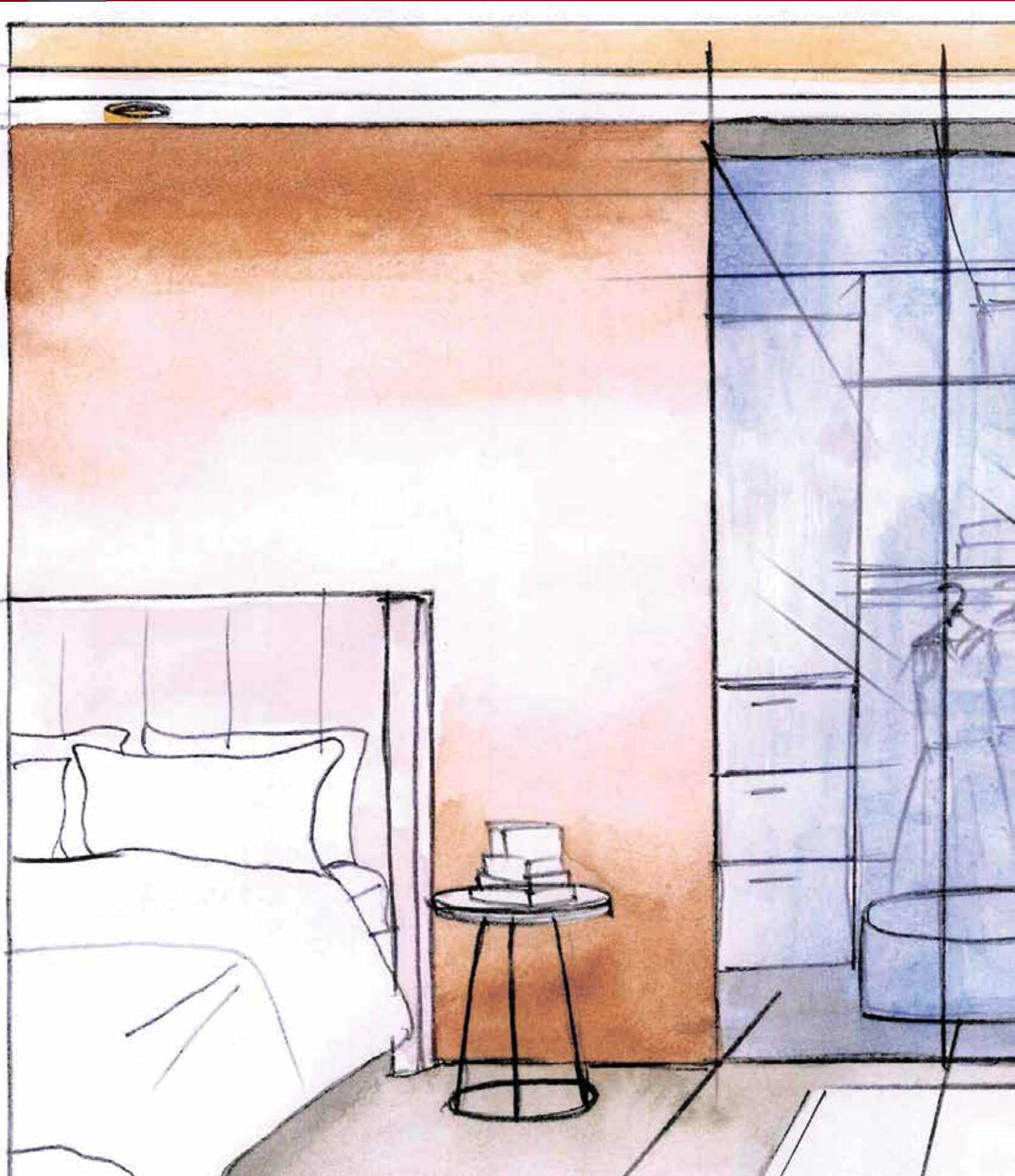





Design Ergo 80

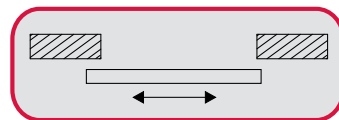
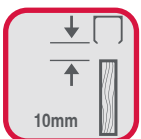
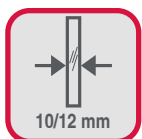
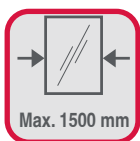

Straight sliding system for glass doors.

Hardware Specification:

- Ideal for dividers and internal doors
- An elegantly designed top quality system
- Concealed lower guide
- Rollers come with an elastic system for absorbing the irregularities of profile (If any)
- High quality Zamak aluminium body
- Proven smooth and silent rolling, thanks to our special anti dust ball bearing system
- Rollers for long lasting rolling durability

Glass Clamp Specification:





- Material: SS304
- Finish: SS polish
- Glass thickness: 10/12 mm
- Adjustable plastic bottom guide



Article No.: 941.10.037
Sliding door kit consists of:

- 2 Rollers with Bracket
- 1 Bottom Guide
- 2 Adjustable Stoppers and other fittings
- 2 Glass Clamps
- 4 Seals



Product Name	Article No.	 L mm	
Aluminium anodized top track (Note: Track to be ordered separately)	409.50.602	2100 mm	
Aluminium anodized top track (Note: Track to be ordered separately)	941.27.432	3000 mm	
OPTIONAL			
Product Name	Article No.	Thickness	
Ergo sliding patch- 22 mm diameter Finish: SS Polished, SS 304	941.10.101		
Wall mounting bracket	940.66.060	3 mm	

Section View:

Wall Mounted

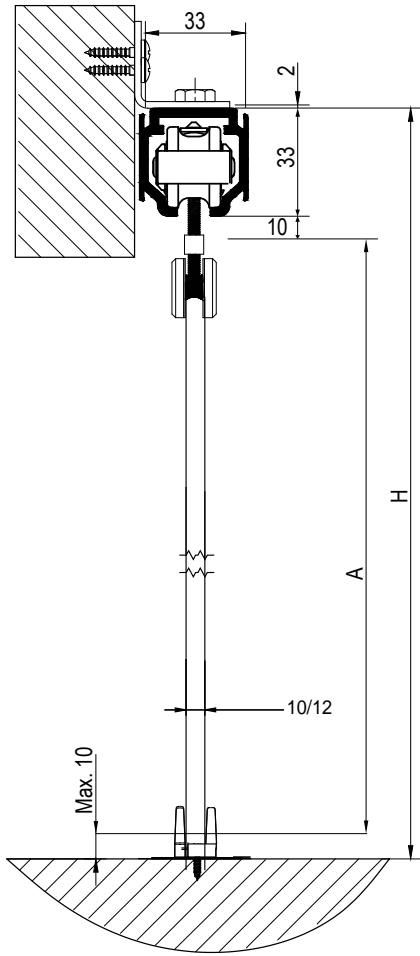

Ceiling Mounted

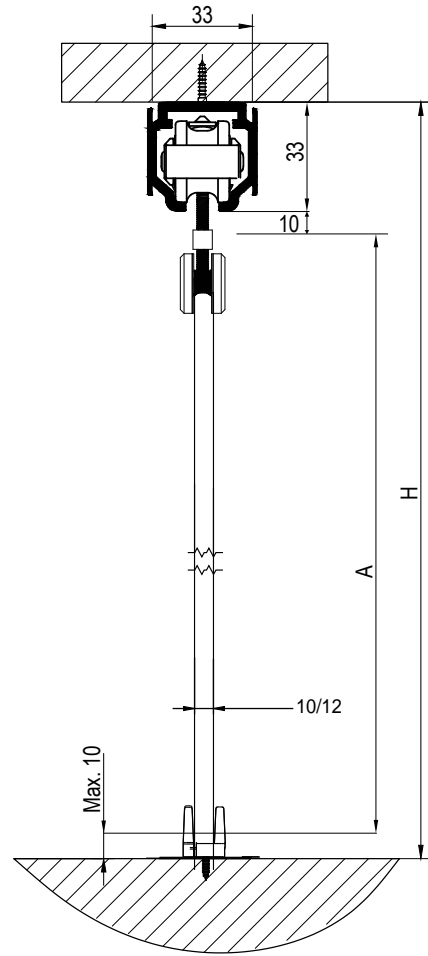

$A = H - 53$

Cut-out Dimensions:

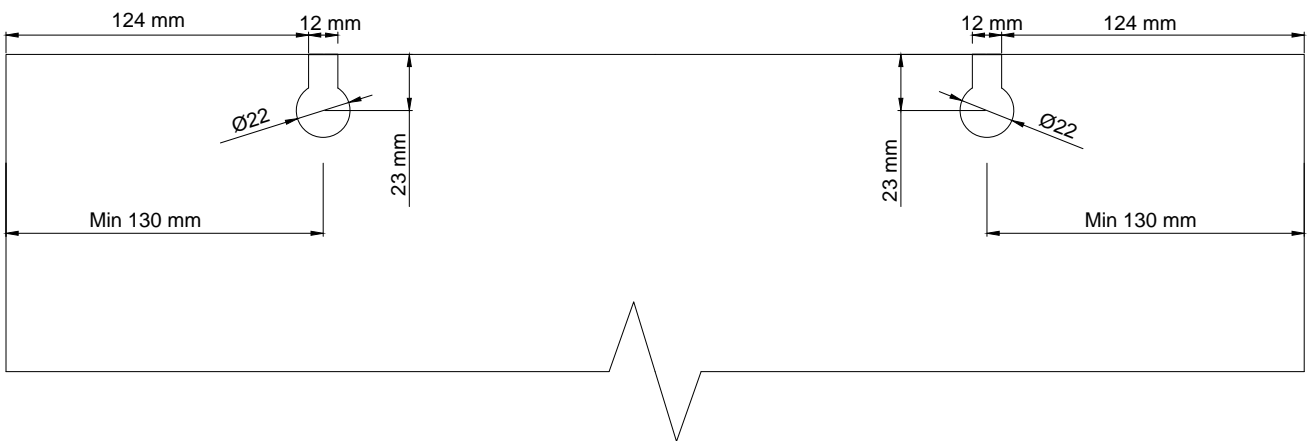

Track Dimension:

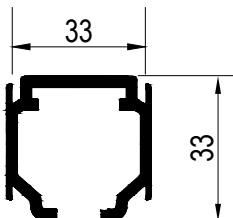

Bottom Guide Cross Section:

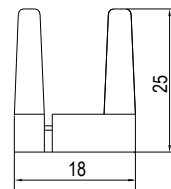

NEW Design Ergo 120

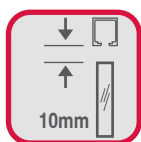
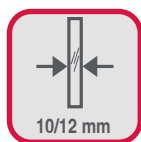
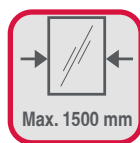

Straight sliding system for glass doors.

Hardware Specification:

- Solid rollers made of high quality Zamak one piece die casting
- Ground shielded ball bearing for silent sliding
- Wheel made up of Delrin, special anti wear compound
- High tech hanger made of high quality Zamak alloy with solid structure and discrete design
- Adjustable bottom guide for perfect alignment of the door run

Glass Clamp Specification:





- Material: SS304
- Finish: SS polish
- Glass thickness: 10/12 mm
- Adjustable plastic bottom guide



Article No.: 941.10.038
Sliding door kit consists of:

- 2 Rollers with Bracket
- 1 Bottom Guide
- 2 Adjustable Stoppers and other fittings
- 2 Glass Clamp
- 4 Seal



Product Name	Article No.		
Aluminium anodized top track (Note: Track to be ordered separately)	941.10.915	1524 mm	
	941.10.918	1828 mm	
	941.10.921	2134 mm	
	941.10.924	2438 mm	
	941.10.927	2743 mm	
	941.10.930	3048 mm	
	941.10.936	3657 mm	
OPTIONAL			
Product Name	Article No.	Thickness	
Wall mounting bracket	940.66.060	3 mm	
Ergo sliding patch- 22 mm diameter Finish: SS Polished, SS 304	941.10.101		

**Section View:
Wall Mounting**

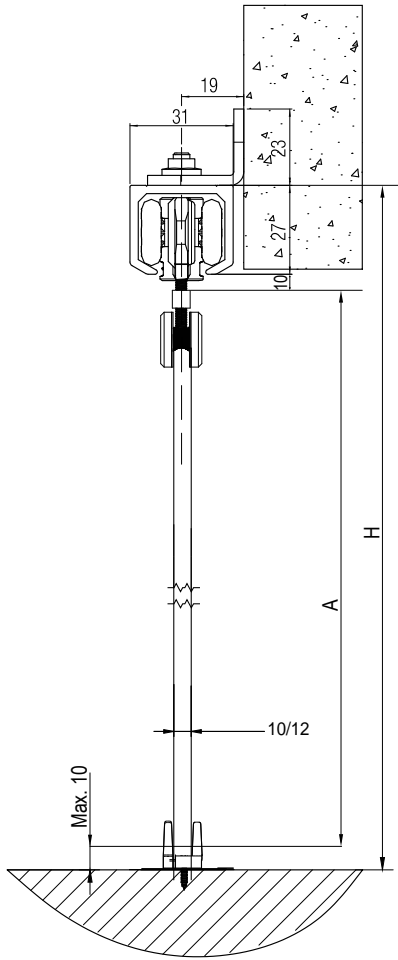

Ceiling Mounting

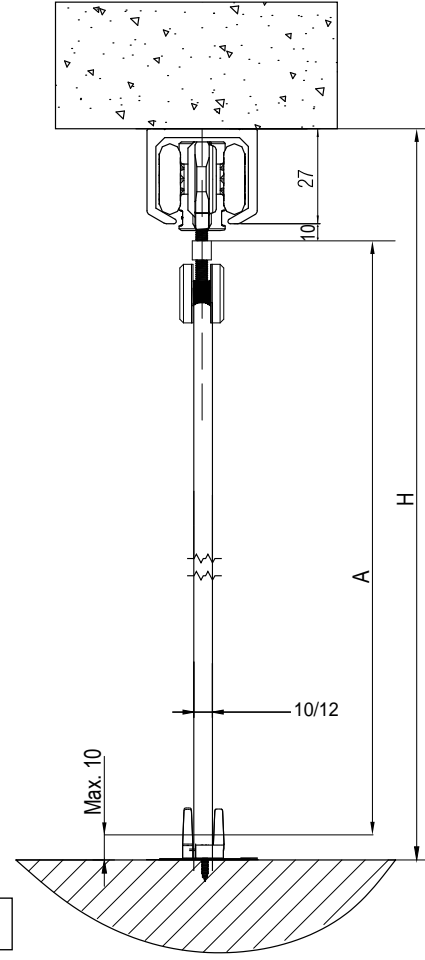

$A = H - 47$

Cut-out Dimensions:

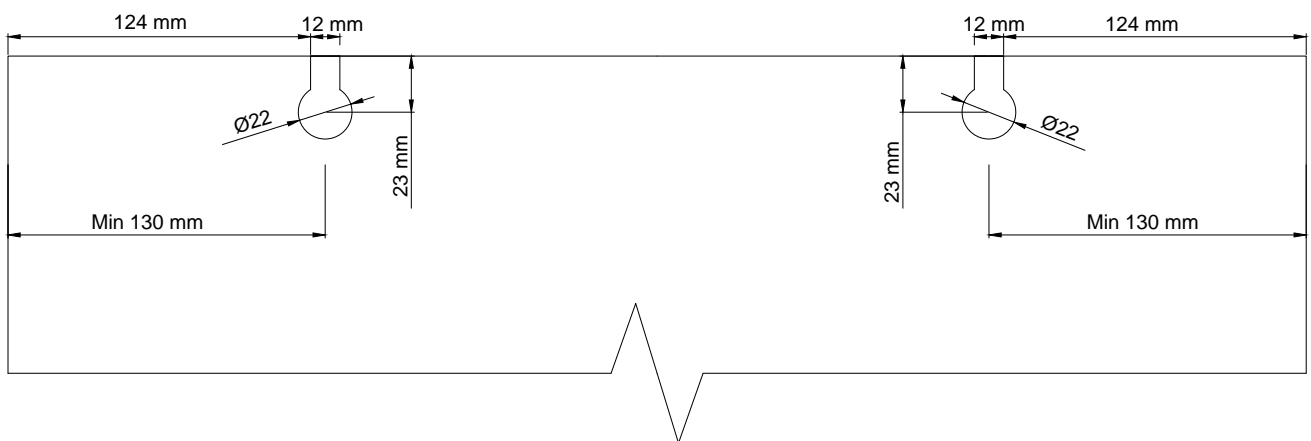

Track Dimension:

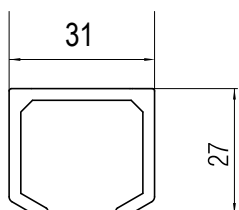

Bottom Guide Cross Section:

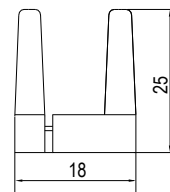

NEW Design Ergo 120
Smuso

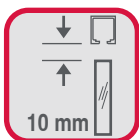
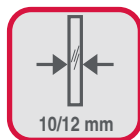
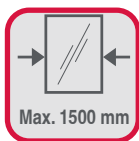

Straight sliding system with soft close for glass doors.

Hardware Specification:

- Highly efficient Double-sided Soft Close technology embedded into the track
- Good quality Zamak (zinc alloy) roller, hanger and carriage set body
- Ground shielded ball bearings around the wheel for silent and smooth sliding
- Wheels made of DELRIN – a special anti-wear compound that offers higher tensile strength, stiffness, resistance, and significantly outperforms on impact resistance
- High tech two-way suspension brackets made of zinc coated steel. The suspension screw can be inserted from the front or the side for easy installation
- Open structure of the rail – prevents dust accumulation
- Compact form of stopper does not afflict the roller wheels – so the wheels do not get damaged when the roller set hits the stopper
- Adjustable bottom (up to 2 mm towards the left or right) for perfect alignment

Glass Clamp Specification:

- Material: SS304
- Finish: SS polish
- Glass thickness: 10/12 mm
- Adjustable plastic bottom guide







Article No.: 941.10.042

Sliding door kit consists of:

- 1 Roller
- 2 Adjustable Stoppers and other fittings
- 1 Two-way Smuso with Rollers
- 2 Activators
- 2 Glass Clamps
- 1 Bottom Guide
- 4 Seals



Product Name	Article No.		
Aluminium anodized top track (Note: Track to be ordered separately)	409.50.603	2000 mm	
	409.50.604	2400 mm	
	409.50.605	3000 mm	
	409.50.606	3600 mm	
OPTIONAL			
Product Name	Article No.	Thickness	
Wall mounting bracket	940.66.060	3 mm	
Ergo sliding patch- 22 mm diameter Finish: SS Polished, SS 304	941.10.101		



Design 120 J

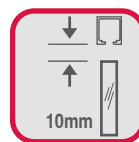
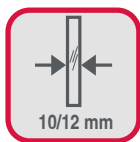
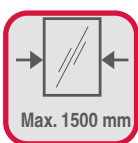

Straight sliding system for single sliding glass doors.

Hardware Specification:

- Solid rollers made of high quality zamak one piece die casting
- Ground shielded ball bearing for silent sliding
- Wheel made of Delrin a special anti wear compound
- Open structure of rail avoids dust accumulation and allows self adjusting running
- Adjustable Stopper: The shape of the stopper doesn't affect the wheel so that the wheel is always free

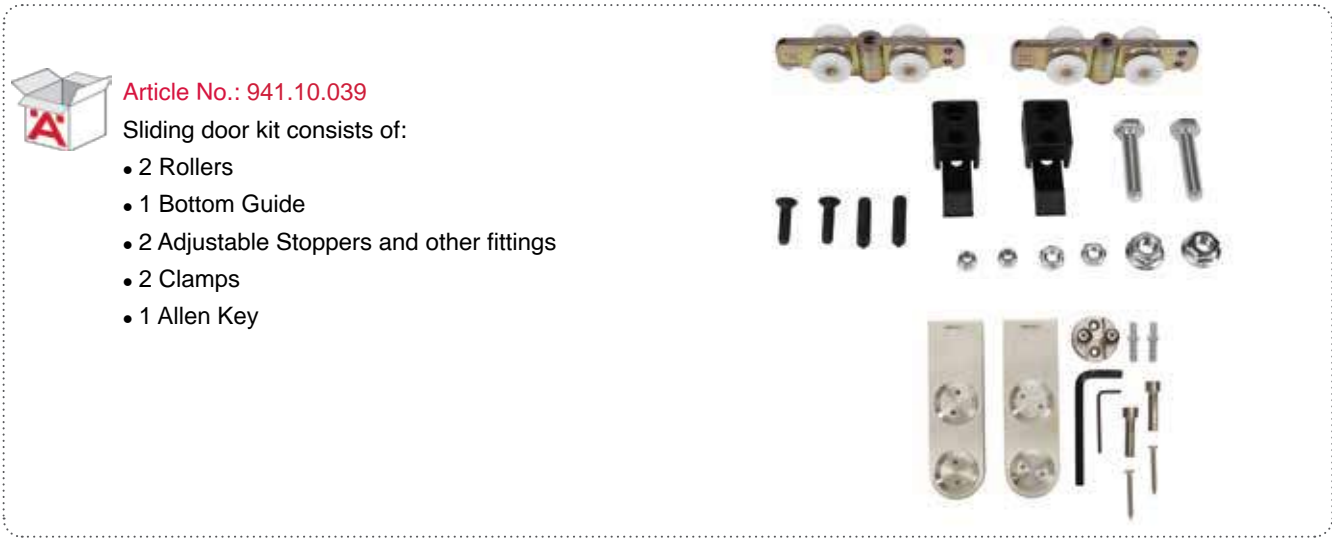

Product Name	Article No.	L mm	
Aluminium anodized top track (Note: Track to be ordered separately)	941.10.915	1524 mm	
	941.10.918	1828 mm	
	941.10.921	2134 mm	
	941.10.924	2438 mm	
	941.10.927	2743 mm	
	941.10.930	3048 mm	
	941.10.936	3657 mm	
OPTIONAL			
Wall mounting bracket	940.66.060	3 mm	
SS 304 Clamp SS Matt Finish	941.10.020		

Section View:
Wall Mounting

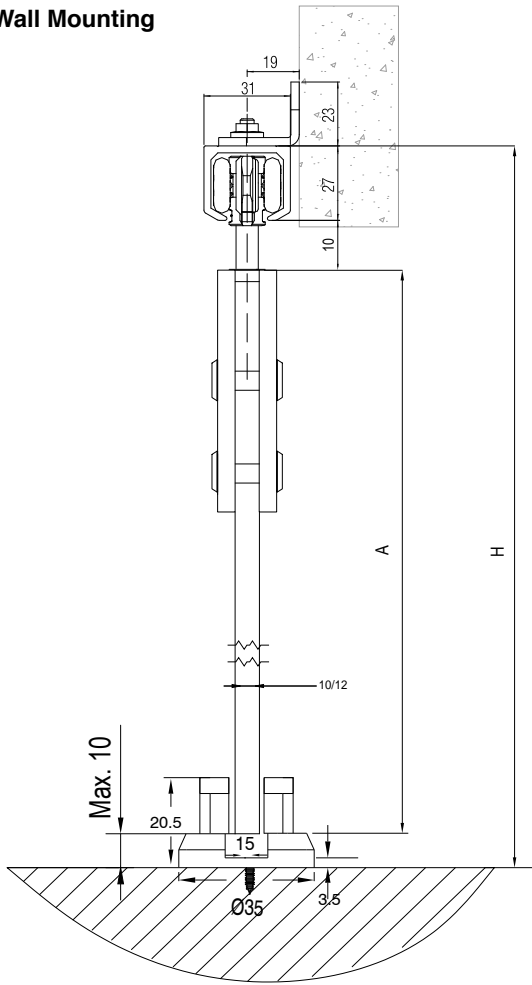

Ceiling Mounting

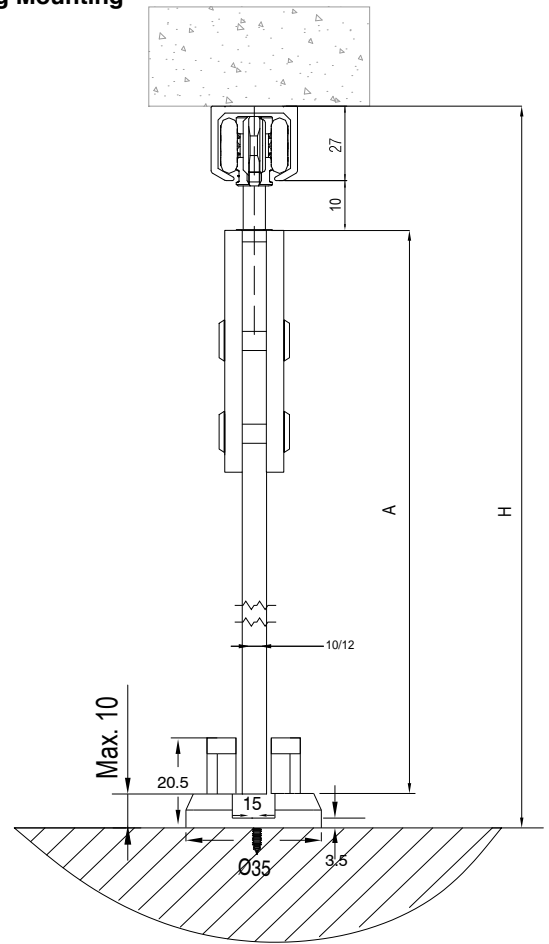

$A = H - 47$

Elevation View:

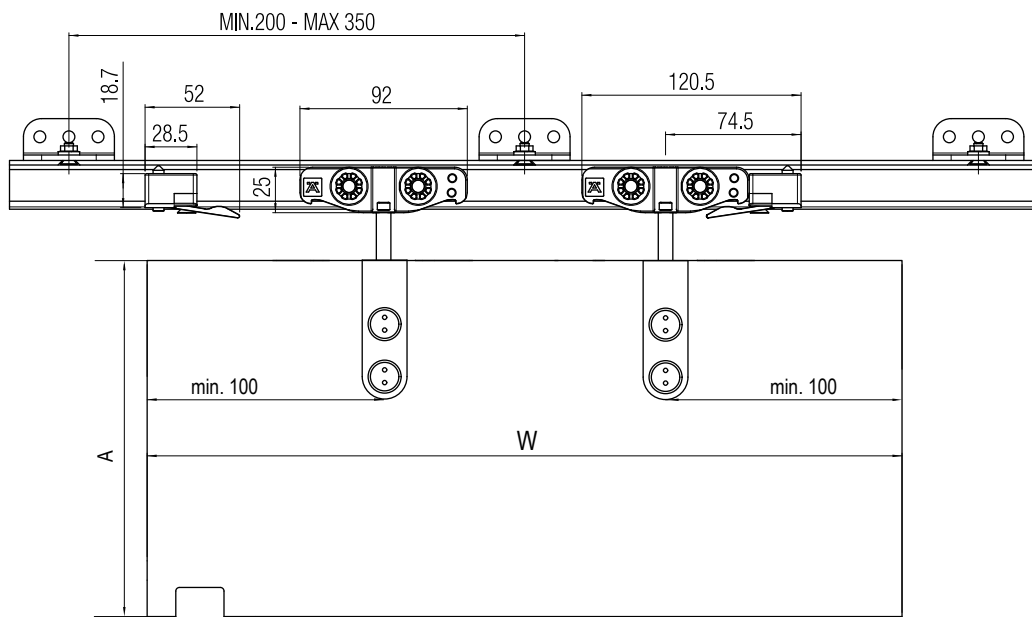

Cut-out Dimension:

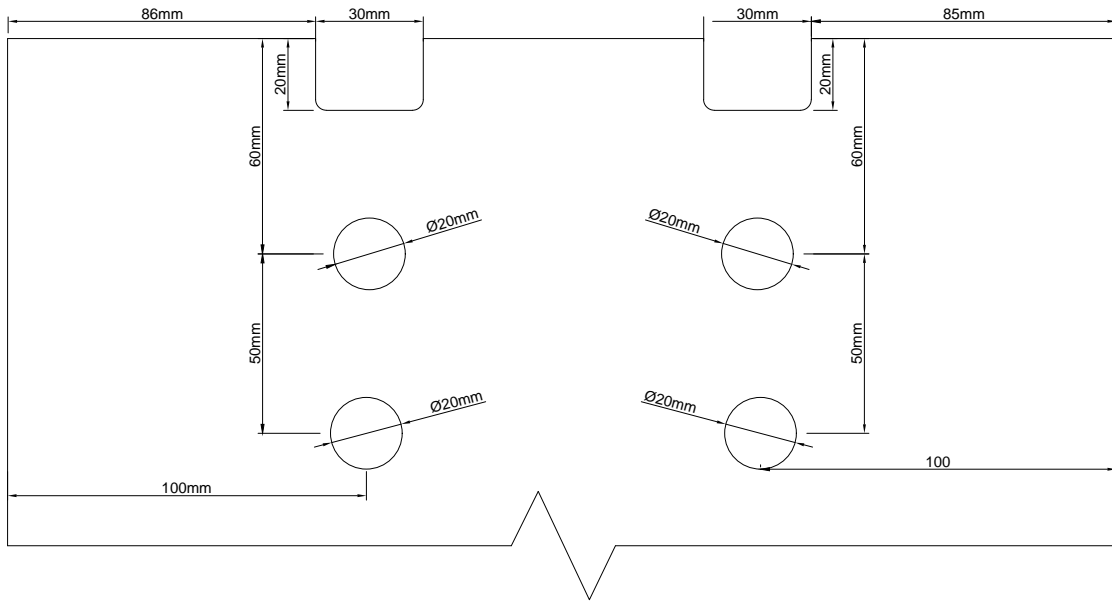

Track Dimensions:

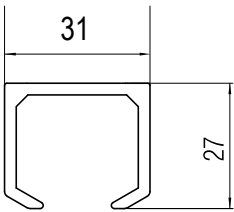

Bottom Guide Cross Section:

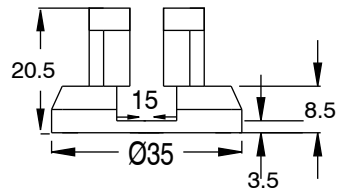



Design 120 J Smuso

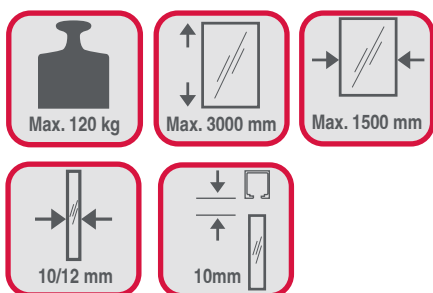

Straight sliding system with soft close for single sliding glass doors.

Hardware Specification:

- Solid rollers made of high quality zamak one piece die casting
- Ground shielded ball bearing for silent sliding
- Wheel made of Delrin a special anti wear compound
- Open structure of rail avoids dust accumulation and allows self adjusting running
- Adjustable Stopper: The shape of the stopper doesn't affect the wheel so that the wheel is always free







Article No.: 941.10.043

Sliding door kit consists of:

- 1 Rollers
- 1 Two-way Smuso with Rollers
- 2 Activators
- 2 Adjustable Stoppers and other fitting
- 2 Clamps
- 1 Bottom Guide
- 1 Allen Key



Product Name	Article No.		
Aluminium anodized top track <small>(Note: Track to be ordered separately)</small>	409.50.603	2000 mm	
	409.50.604	2400 mm	
	409.50.605	3000 mm	
	409.50.606	3600 mm	
OPTIONAL			
Wall mounting bracket	940.66.060	3 mm	
SS 304 Clamp SS Matt Finish	941.10.020		

Section View:
Wall Mounting

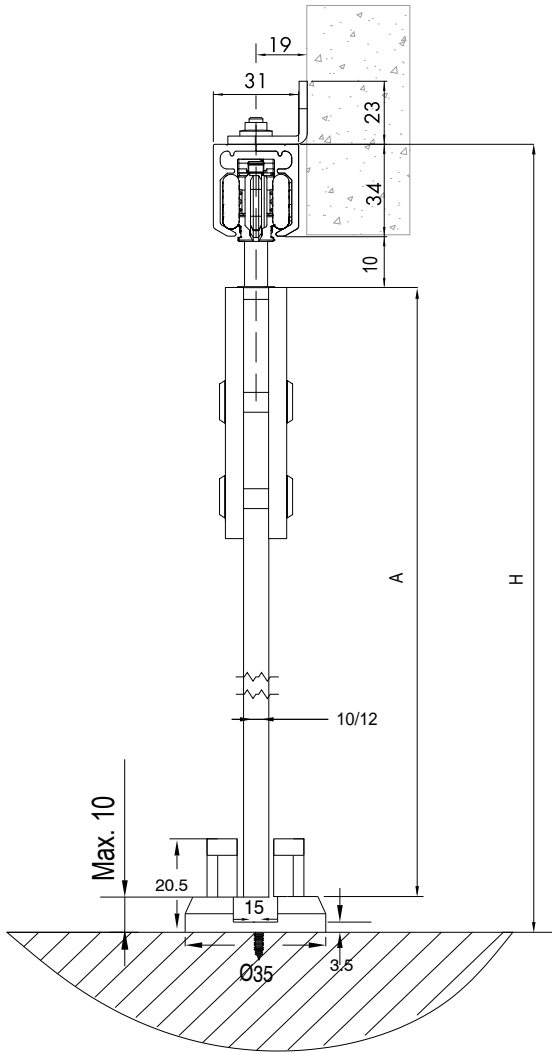

Ceiling Mounting

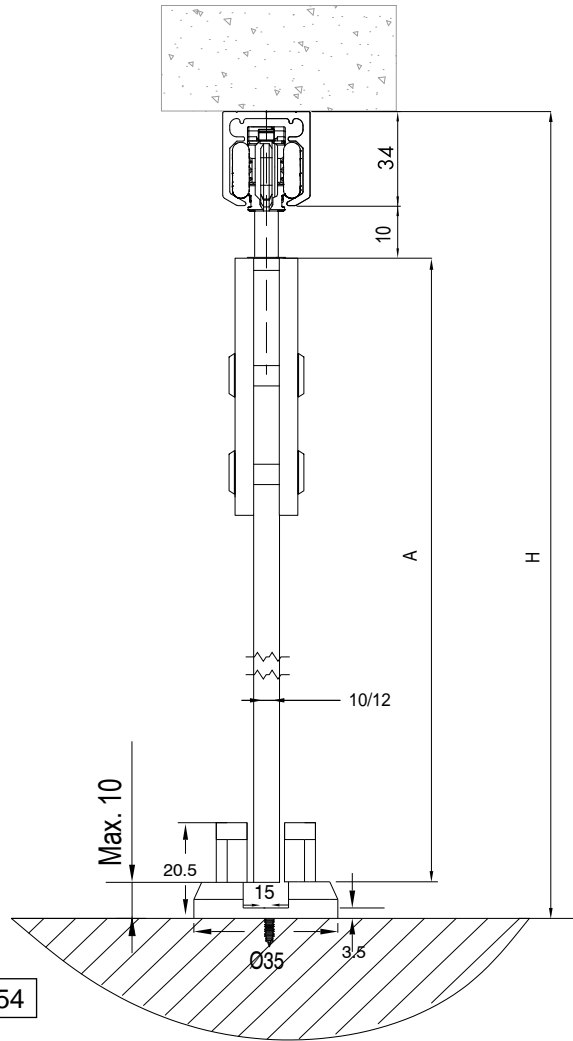

$A = H - 54$

Elevation View:

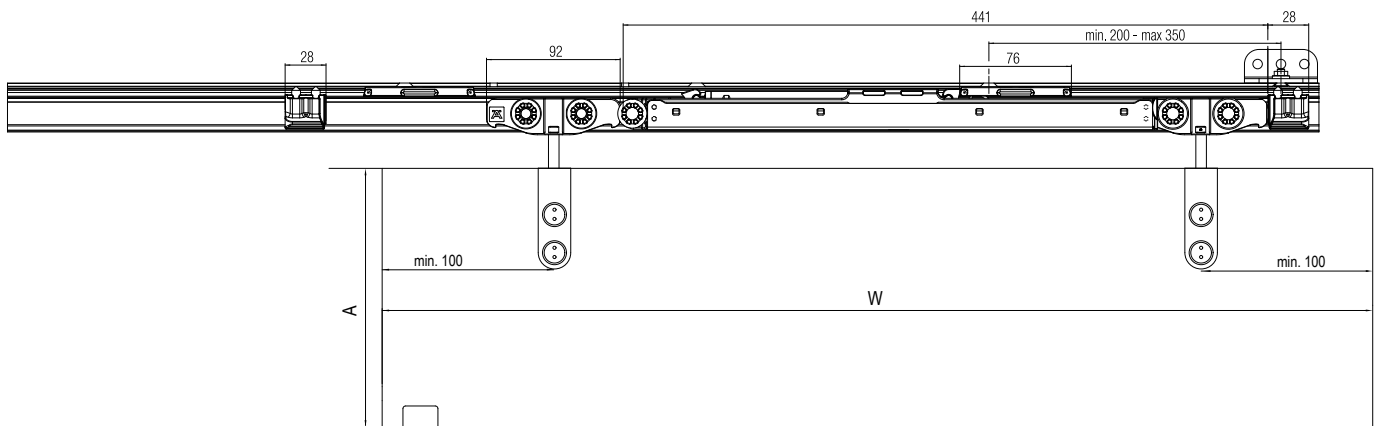

Cut-out Dimension:

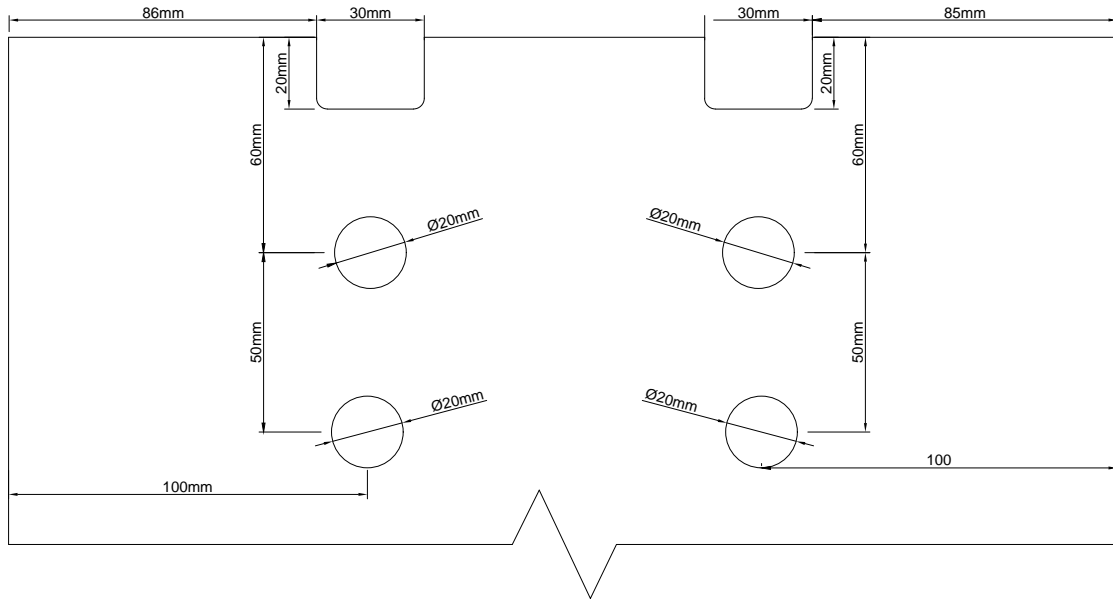

Track Dimension:

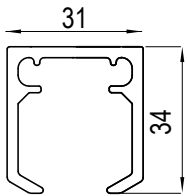

Bottom Guide Cross Section:

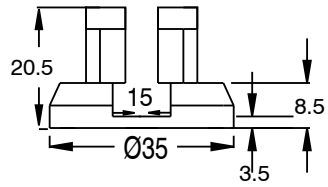



Design 120 SS

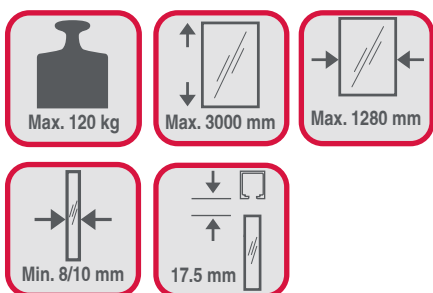

Straight sliding system for glass doors.

Hardware Specification:



- The rollers are made up of die cast alloy with delrin covered ground shielded ball bearing wheels
- The glass grippers can be adjusted for different glass thickness
- The clamping shoes have a safety pin to prevent the door slipping with time
- Separate aluminium profile to cover the glass grippers



Article No.:941.10.040
Sliding door kit consists of:

- 1 Bottom Guide
- 1 1280mm Aluminium Profile
- 2 Side Covers
- 2 Fixing Clamps
- 2 Rollers
- 2 Adjustable Stoppers and other fittings



Product Name	Article No.	L mm 	
Aluminium anodized top track (Note: Track to be ordered separately)	941.10.915	1524 mm	
	941.10.918	1828 mm	
	941.10.921	2134 mm	
	941.10.924	2438 mm	
	941.10.927	2743 mm	
	941.10.930	3048 mm	
	941.10.936	3657 mm	

**Section View:
Ceiling Mounting**

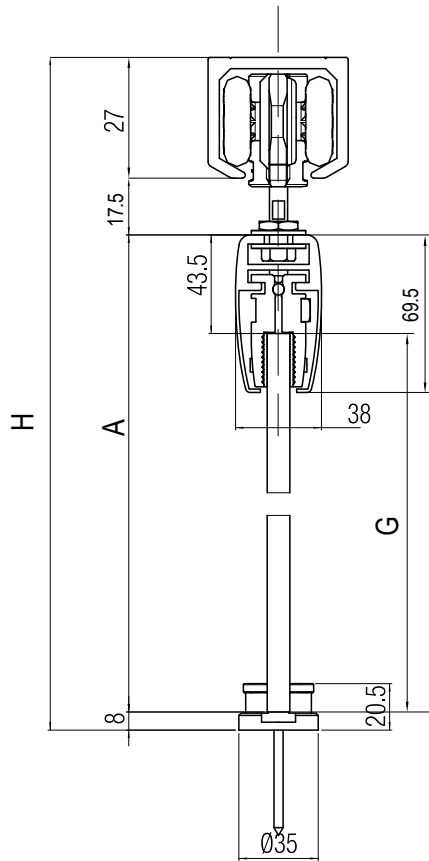

$A = H - 52.5$ $G = A - 43.5$

A = Total door height (with profile)
G = Glass height
H = Total opening height

Elevation View:

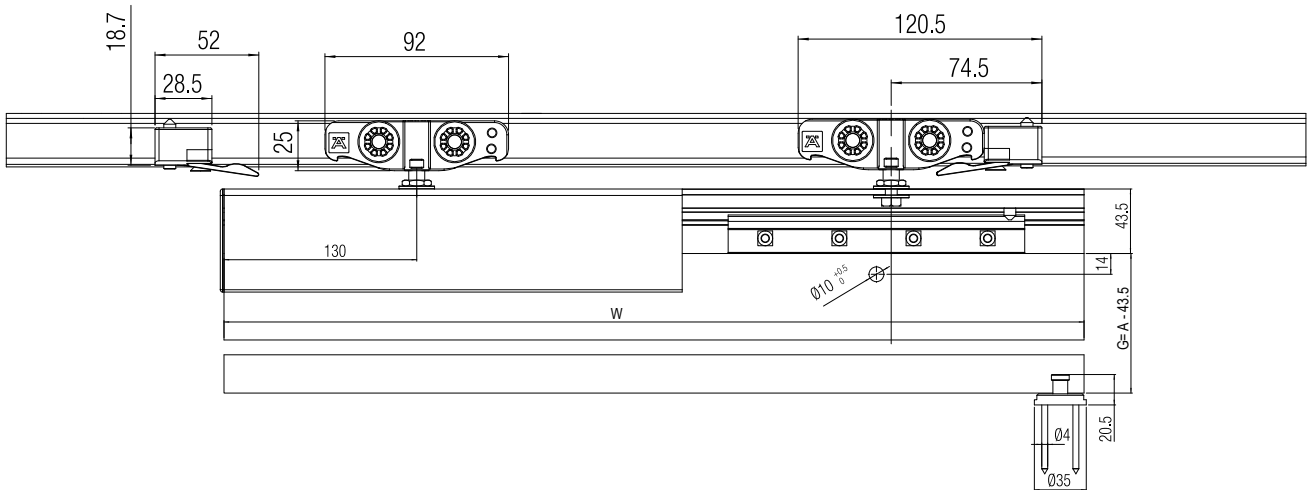

Track Dimension:

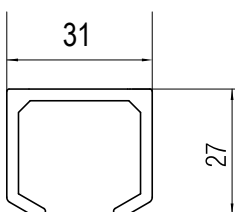

Bottom Guide Cross Section:

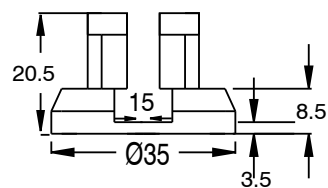

SLIDO

NEW

Design 120 SS Smuso



Straight sliding system with soft close for glass doors.

Hardware Specification:

- The rollers are made up of die cast alloy with delrin covered ground shielded ball bearing wheels
- The glass grippers can be adjusted for different glass thickness
- The clamping shoes have a safety pin to prevent the door slipping with time
- Separate aluminium profile to cover the glass grippers





Article No.: 941.10.044

Sliding door kit consists of:

- 1 Bottom guide
- 1 1280mm aluminium profile
- 2 Side covers
- 2 Fixing clamps
- 1 Roller
- 1 Two-way smuso with rollers
- 2 Activators
- 2 Adjustable stoppers and other fittings



Product Name	Article No.		
Aluminium anodized top track (Note: Track to be ordered separately)	409.50.603	2000 mm	
	409.50.604	2400 mm	
	409.50.605	3000 mm	
	409.50.606	3600 mm	

Section View:
Ceiling Mounting

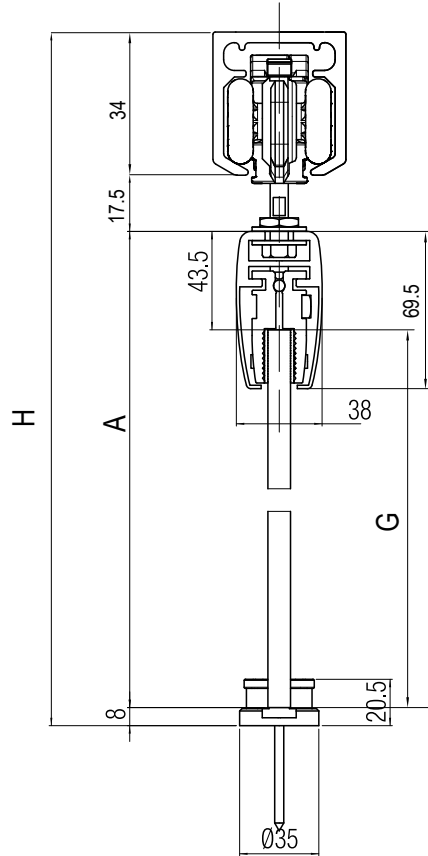

$$A = H - 59.5$$

$$G = A - 43.5$$

A = Total door height (with profile)
G = Glass height
H = Total opening height

Elevation View:

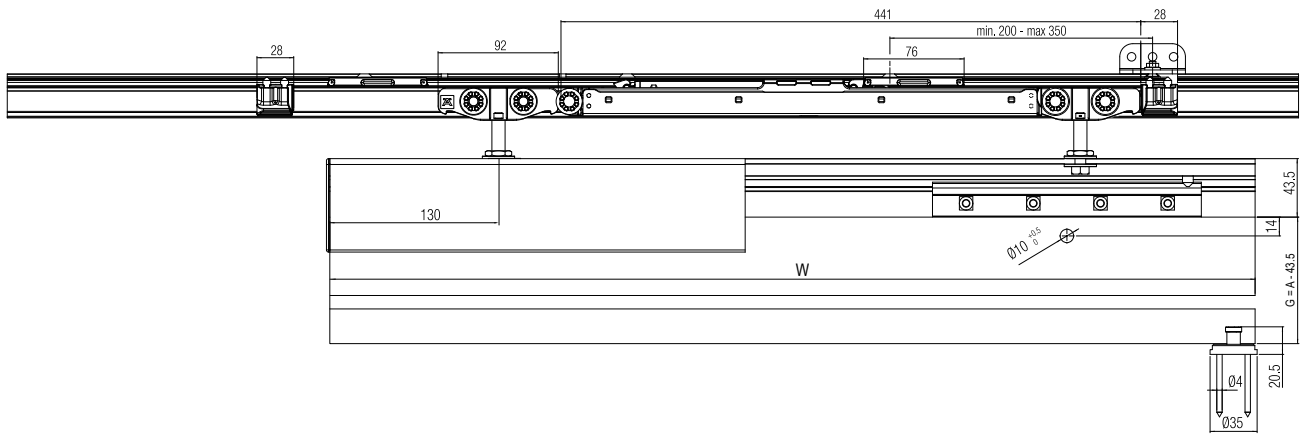

Track Dimension:

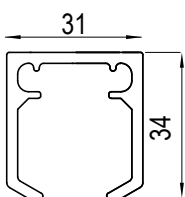

Bottom Guide Cross Section:

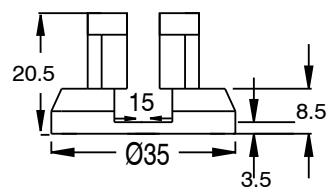

Design 80 L

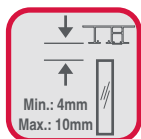
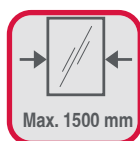

Straight sliding system for glass doors.
Track concealed in false ceiling, No glass preparation required.

Hardware Specification:











- Ideal for dividers and glass doors up to 80 kg.
- False ceiling application possible.
- System applicable with a profile for false ceilings.
- 2mm minimum gap between bracket and profile.
- Elegant design.
- **No glass preparation (cut-out) required.**



Article No.: 940.99.091
Sliding door kit consists of:

- 2 Rollers with Bracket
- 2 Adjustable Stoppers
- 1 Bottom Guide and other fittings



Product Name	Article No.		
Silver anodised aluminium double track for false ceiling application with fixed glass. (Note: Track to be ordered separately)	940.99.931	3000 mm	
Aluminium anodized top track (Note: Track to be ordered separately)	941.27.432	3000 mm	
Silver anodised aluminium track for fixed glass (Note: track to be ordered separately)	940.99.830	3000 mm	
Silver anodised aluminium trim cover (Note: trim cover to be ordered separately)	940.99.730	3000 mm	
Bottom track for fixed glass (Note: Track to be ordered separately)	943.39.815	3000 mm	
Aluminium trim cover with stainless steel finish (Note: Trim cover to be ordered separately)	940.99.731	3000 mm	
Trim cover for profile - fixed glass (Note: Trim cover for Fixed Glass to be ordered separately)	940.99.130	3000 mm	
End trim cover for glass thickness 8mm (Note: End trim cover to be ordered separately)	940.99.061	-	
End trim cover for glass thickness 10mm (Note: End trim cover to be ordered separately)	940.99.062	-	

**Section View:
Concealed + Fixed Glass Mounting**

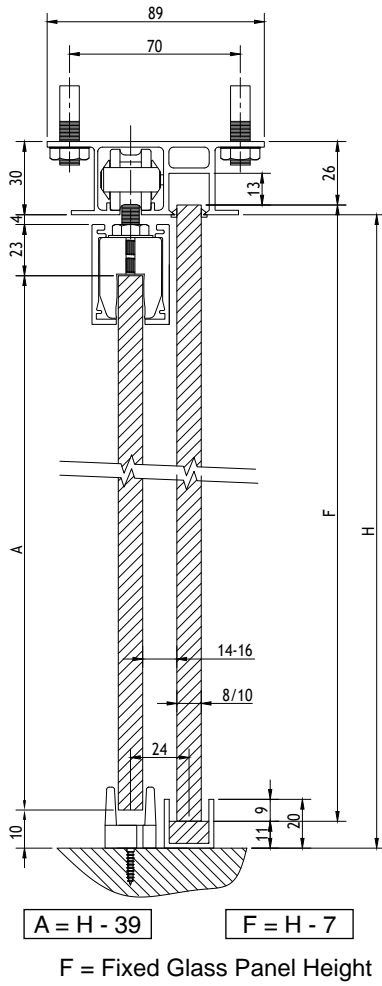

Ceiling Mounting

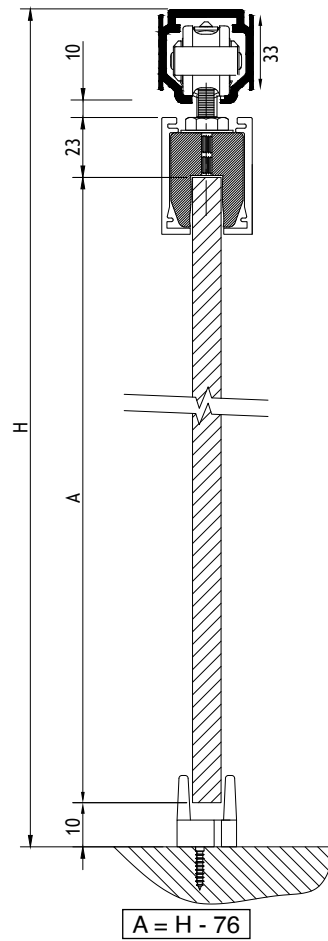

Elevation View:

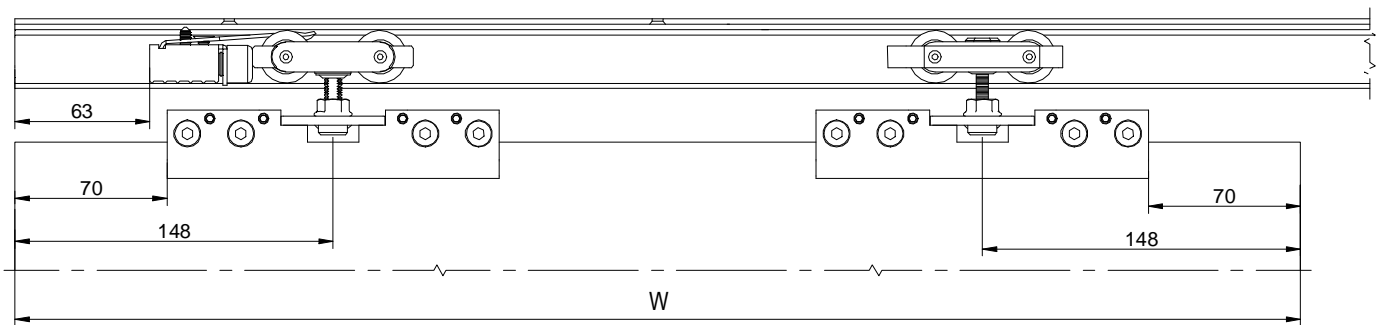

No glass preparation (cut-out) required.

**Track Dimension:
Concealed + Fixed**

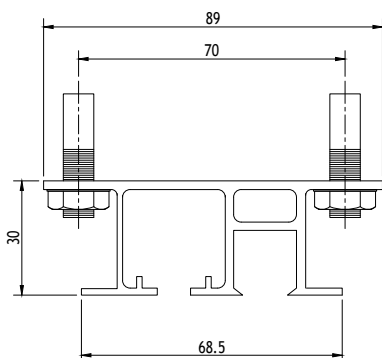

Ceiling Track

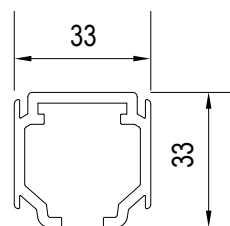

**Bottom Guide
Cross Section:**

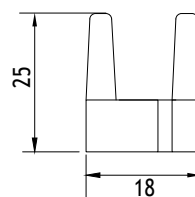

**Bottom Track
Cross Section:**

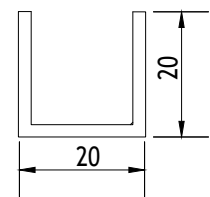

Design 80 SVX

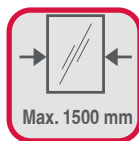

Straight sliding system for glass doors.

Hardware Specification:

- Ideal for dividers and glass doors up to 80kg weight
- Possible to install in combination with fixed glass
- Top track can fit to fixed glass
- Top track can fit to side walls
- **No glass preparation (cut-out) required**



Article No.: 940.99.095

Sliding door kit consists of:

- 2 Rollers with Bracket
- 2 Adjustable Stoppers
- 1 Bottom Guide



Product Name	Article No.	L mm 	
Silver anodized aluminium upper track (Note: Track to be ordered separately)	940.99.320	2000 mm	
	940.99.330	3000 mm	
Silver anodized aluminium upper track for fixed glass (Note: Track to be ordered separately)	940.99.321	2000 mm	
	940.99.331	3000 mm	
Silver anodized aluminium trim cover (Note: Trim cover to be ordered separately)	940.99.420	2000 mm	
	940.99.430	3000 mm	
Silver anodised aluminium trim cover for fixed glass (Note: Trim cover to be ordered separately)	940.99.421	2000 mm	
Wall glass support (Note: Wall glass support to be ordered separately)	940.99.060	-	
Trim cover (Note: Trim cover to be ordered separately)	940.99.032	-	
Trim cover for fixed glass (Note: Trim cover to be ordered separately)	940.99.031	-	
Bottom track for fixed glass (Note: Track to be ordered separately)	943.39.815	-	
Floating support (Note: Floating support to be ordered separately)	940.99.063	-	

Section View:

Application - 1
One Sliding Door
Ceiling Mounting

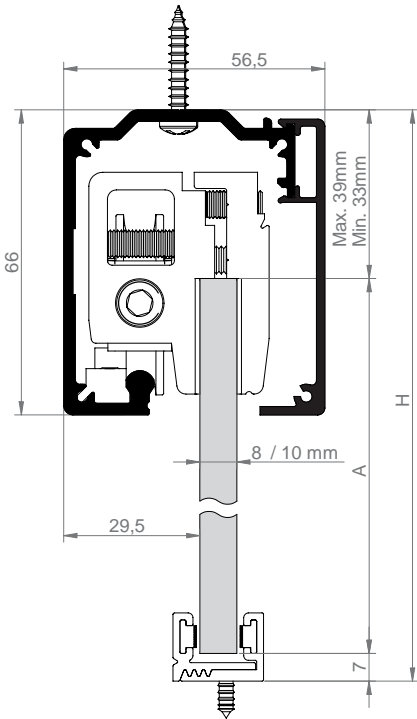

A min. = H - 46
A max. = H - 40

Application - 2
One Sliding Door + One Fixed Panel
Ceiling Mounting

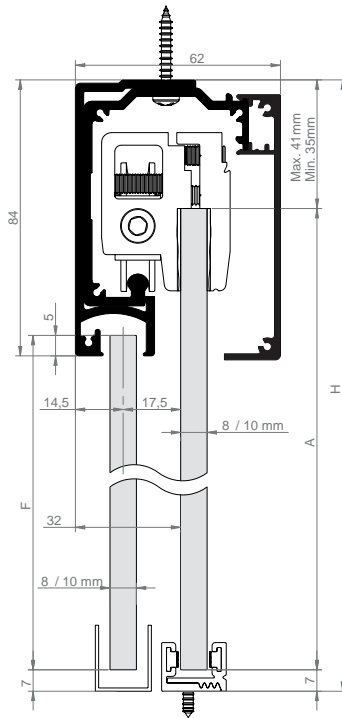

F = H - 86
A min. = H - 48
A max. = H - 42

F = Fixed Glass
Panel Height

Application - 3
One Sliding Door
Wall Mounting

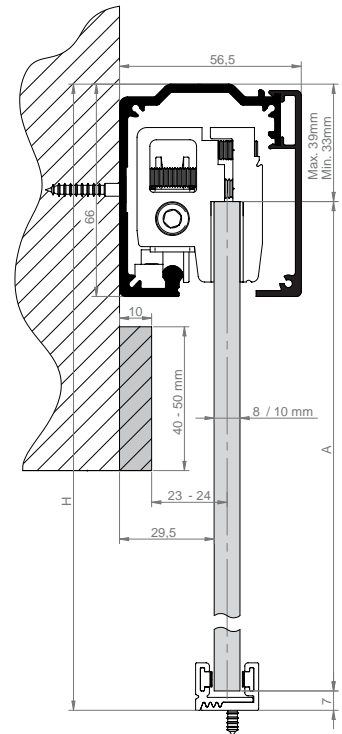

A min. = H - 46
A max. = H - 40

Application - 4

Glass Wall Mounting

One Sliding + One Fixed Panel Track
Preset to Fixed Panel

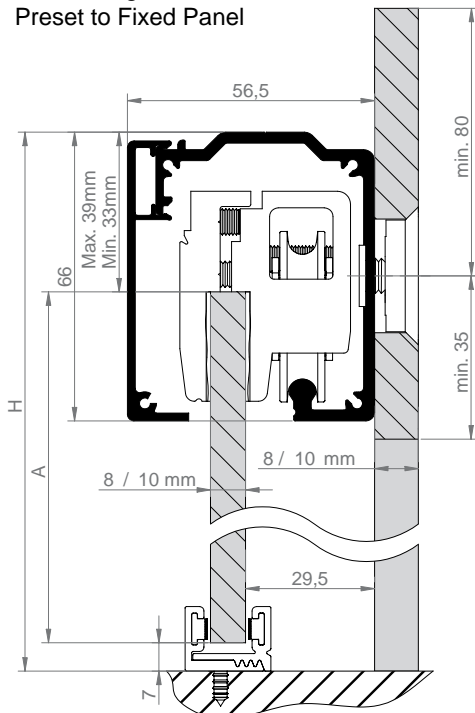

A min. = H - 46
A max. = H - 40

Drilling Pattern

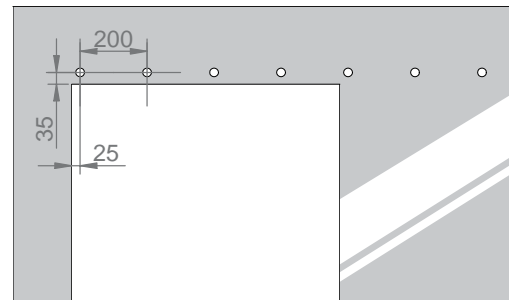

Cut-out Dimension

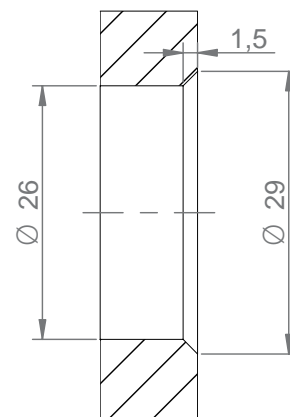

Application - 5

Track attach to the side walls

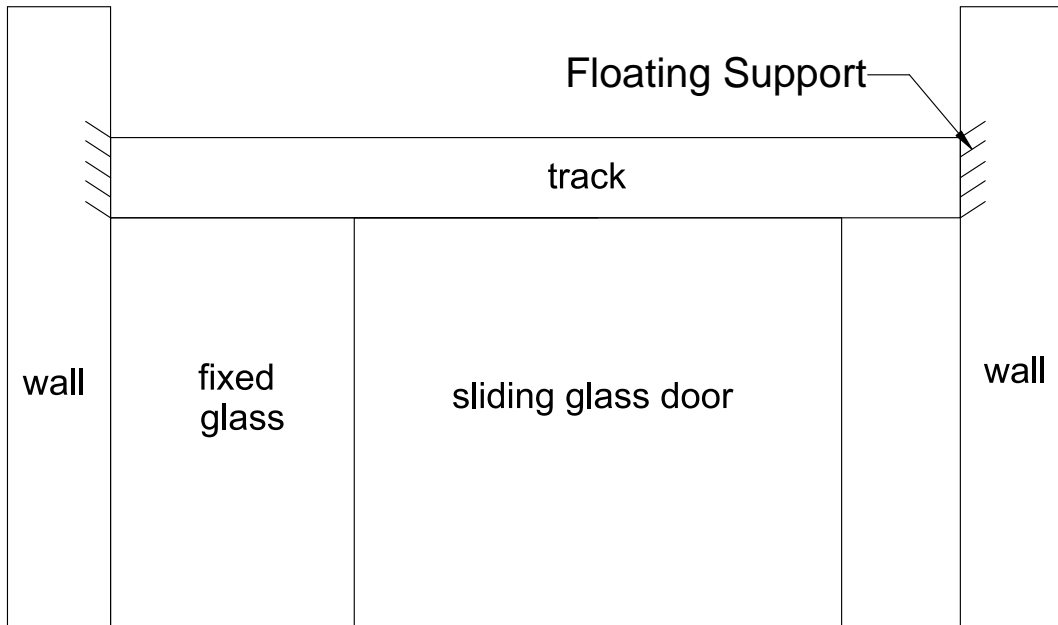

Track Dimension:

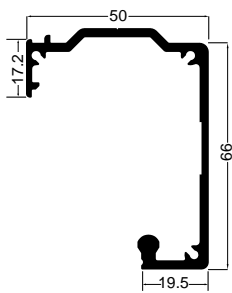

Bottom Guide Cross Section:

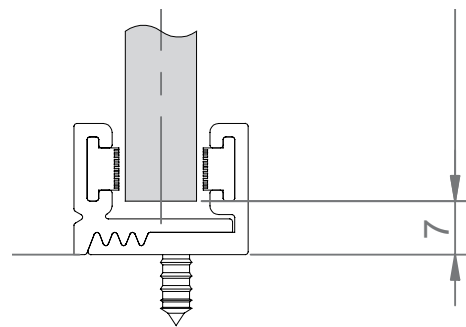

Design 80M

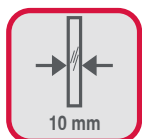

Straight sliding system for glass doors.

Hardware Specification:

- Patented product that guarantees functionality and aesthetical renovation
- Track and sliding gear are completely concealed – all you can see is the clean, flush door fronts
- Advanced operational technology yet easy to install
- High quality system components guarantee durability and operational functionality
- Come with breaking dampers for smooth and soft opening and closing of the doors



Article No.: 940.59.007

- Top Track Profile
- Bottom Guide
- Top Track
- Housing for Bottom Gear
- Bottom Track Profile
- Bottom Running Gear
- Bottom Track
- Fixing Brackets for Top Gear
- Cover Caps for Top Track
- Top Running Gear
- Cover Caps for Top Track Profile
- Damping mechanism for Top Track
- Cover Caps for Bottom Track
- Distance Spacers
- Allen Key and Fixing Screws

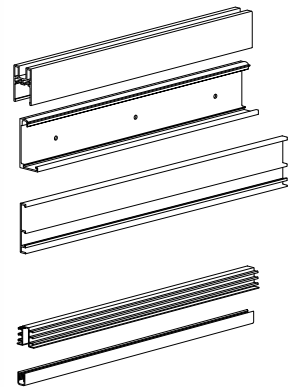

Section View:

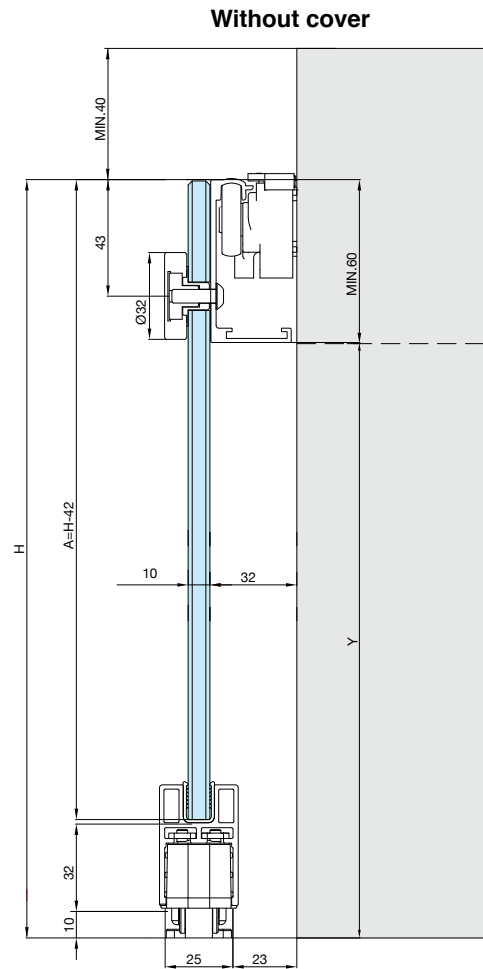
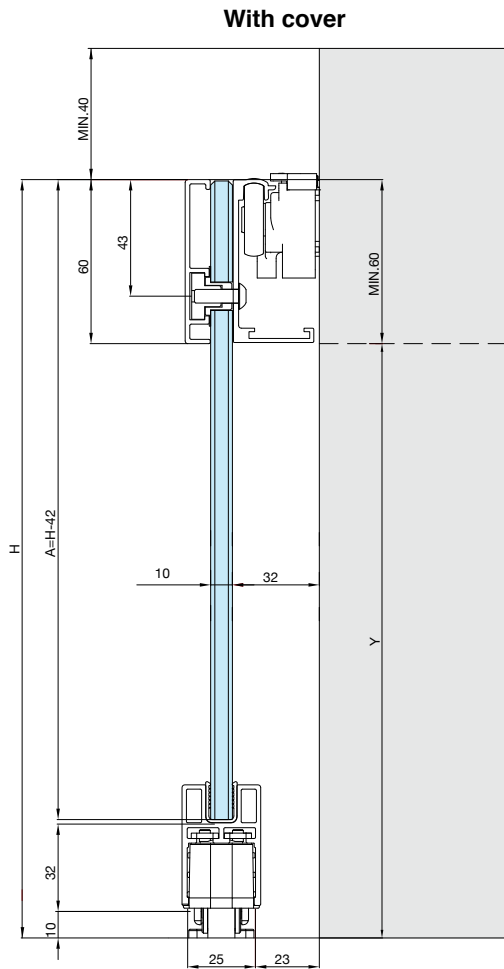

$A = H - 42$

Glass Drilling Pattern:

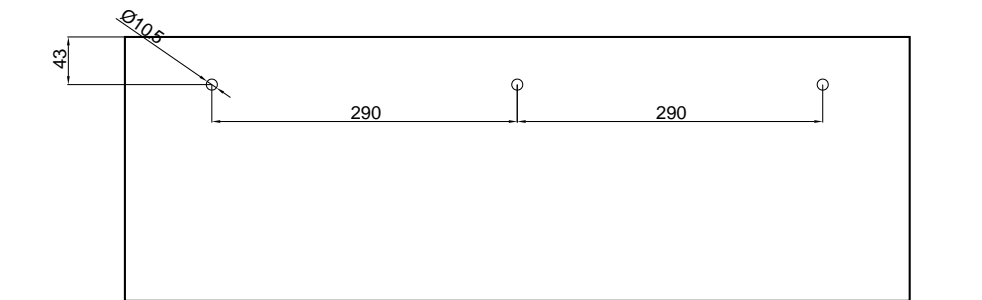

Standard Position

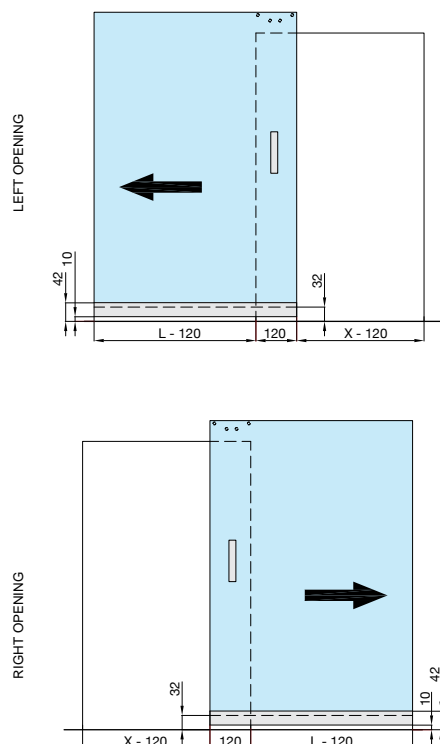

B = 0 mm (Min.)
B = 50 mm (Suggested)

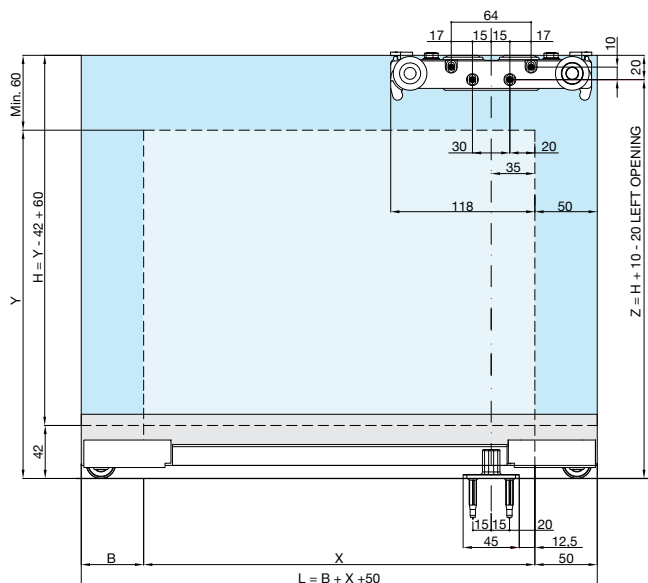

B=0
X= MIN. 800 (L=850) / X= MAX. 1050 (L=1100)
B=50
X= MIN. 800 (L=900) / X= MAX. 1000 (L=1100)

B=0
X= MIN. 800 (L=850) / X= MAX. 1750 (L=1800)
B=50
X= MIN. 800 (L=900) / X= MAX. 1700 (L=1800)

Intermediate Position

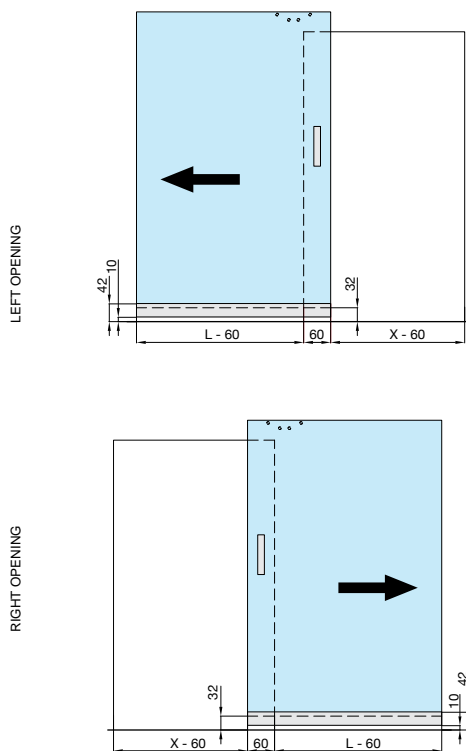

B = 0 mm (Min.)
B = 50 mm (Suggested)

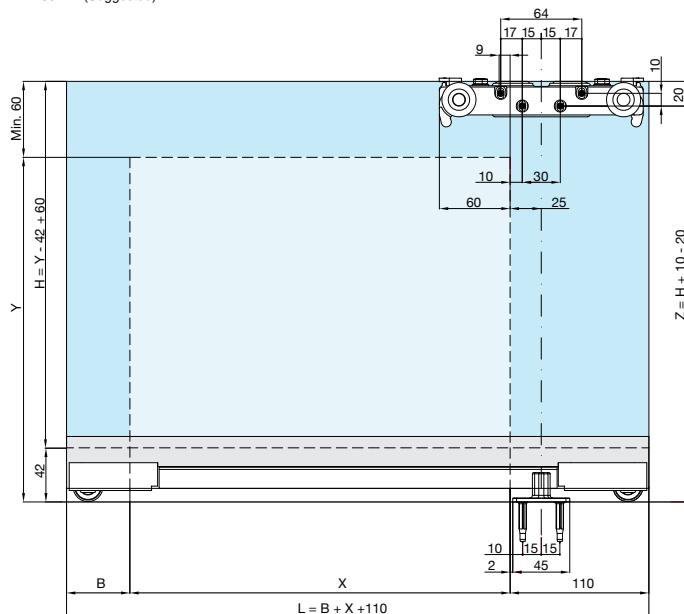

B=0
X= MIN. 740 (L=850) / X= MAX. 990 (L=1100)
B=50
X= MIN. 740 (L=900) / X= MAX. 940 (L=1100)

B=0
X= MIN. 740 (L=850) / X= MAX. 1690 (L=1800)
B=50
X= MIN. 740 (L=900) / X= MAX. 1640 (L=1800)

Total Opening Position

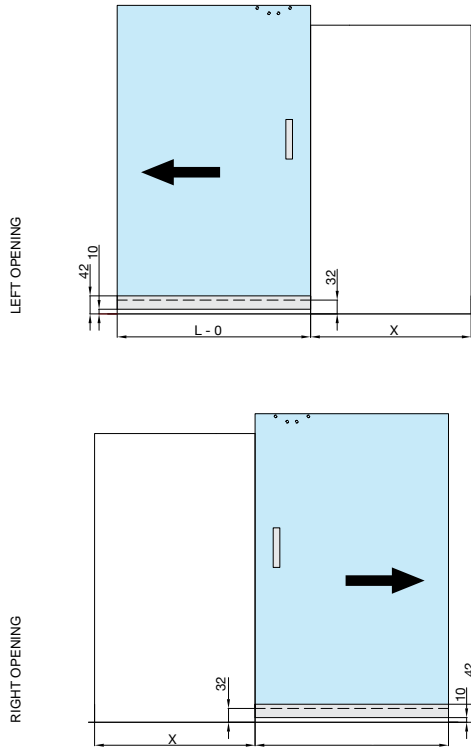

B=0
 X= MIN. 680 (L=850) / X= MAX. 930 (L=1100)
 B=50
 X= MIN. 680 (L=900) / X= MAX. 880 (L=1100)

B = 0 mm (Min.)
 B = 50 mm (Suggested)

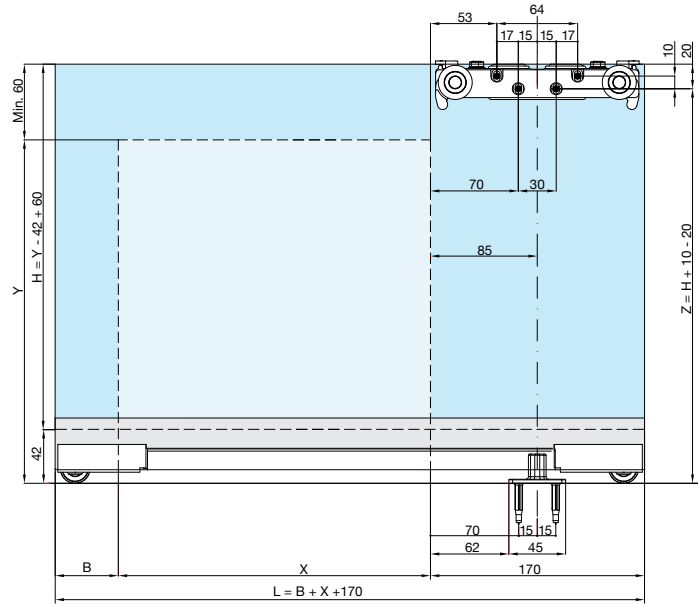

B=0
 X= MIN. 680 (L=850) / X= MAX. 1630 (L=1800)
 B=50
 X= MIN. 680 (L=900) / X= MAX. 1580 (L=1800)

Design 85 SV

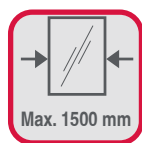

Straight sliding system for double sliding glass doors on single track.

Hardware Specification:





- Ideal for dividers and closet doors
- System with a single track for 2 panels
- Adjustable lower guide from 8/10mm
- Vertically adjustable ball bearing wheels (Adjustment: + 6mm)
- **No glass preparation (cut-out) required**



Article No.: 940.99.094
Sliding door kit consists of:

- 2 Rollers with Bracket
- 2 Adjustable Stoppers and other fittings
- 2 Screws
- 1 Bottom Guide



Product Name	Article No.	L mm ← →	
Silver anodised aluminium track (Note: Track to be ordered separately)	940.99.630	3000 mm	
	940.99.650	5000 mm	
Silver aluminium anodized trim cover (Note: Trim cover to be ordered separately)	940.99.530	3000 mm	
	940.99.550	5000 mm	
OPTIONAL			
Product Name	Article No.		
Aluminium separator	940.99.093		
Trim cover support	940.99.081		
Wall mounting bracket	940.99.082		

Section View:

Wall Mounting:

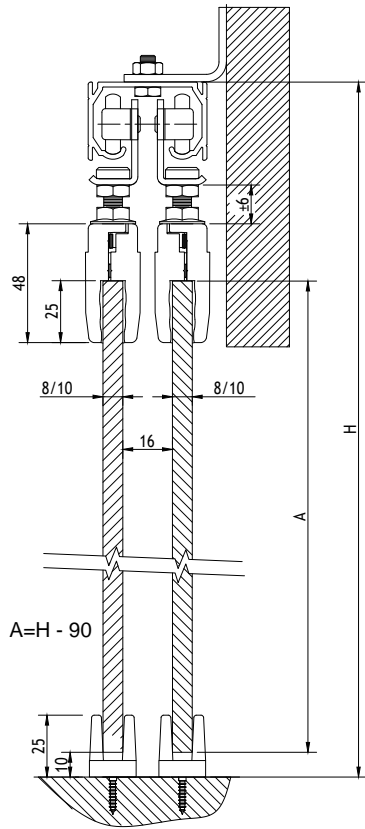

Ceiling Mounting:

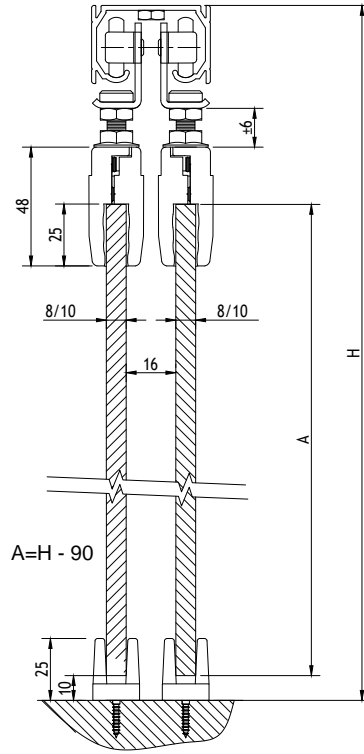

Concealed Mounting:

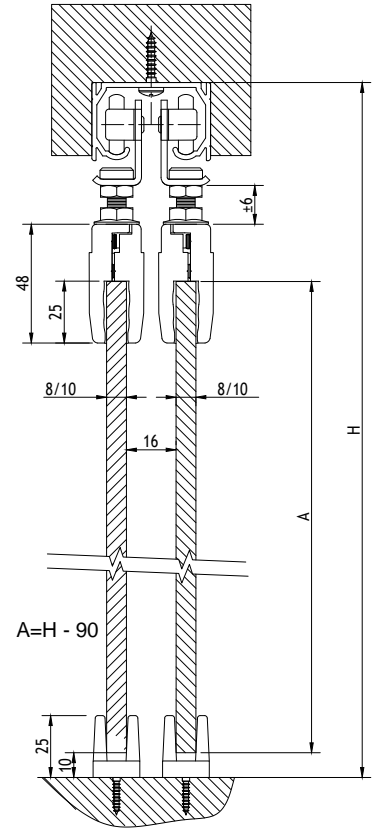

Elevation View:

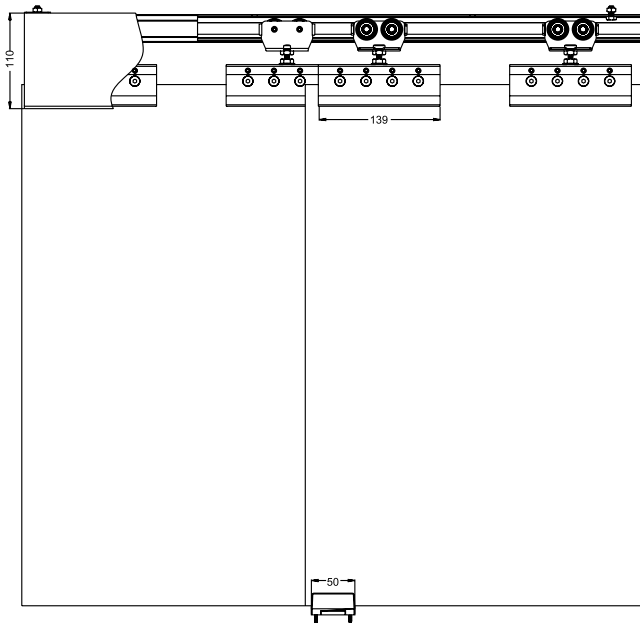

Track Dimension:

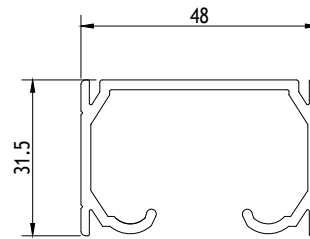

Bottom Guide Cross Section:

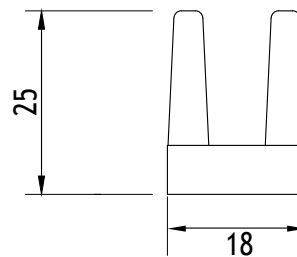



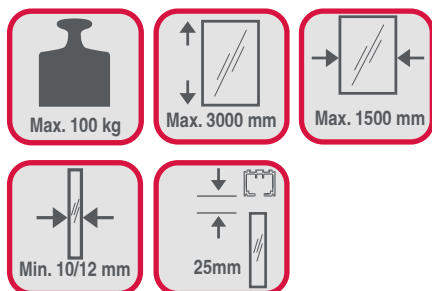





Design 100 C





Straight sliding system for glass doors.

Hardware Specification:

- System with robust and elegant hangers
- Stopper with inbuilt spring action to prevent vibration
- Roller hanger having offset shaft for adjusting door panel up and down
- Plastic roller wheels having higher anti wear performance

Product Name	Article No.	Finish	
2 Rollers	941.16.012	SS matt	
End Door Stopper	941.16.042	SS matt	
Middle Door Stopper	941.16.043	SS matt	
Glass Support for Track	941.16.031	SS matt	
Wall Support for Track	941.16.032	SS matt	
End Wall Support for Track	941.16.033	SS matt	
Universal Joint for Track	941.16.034	SS matt	
Bottom Guide for 10 or 12mm Glass	941.16.035	SS matt	
Fixing Tool	941.16.036	SS matt	

Product Name	Article No.		
Aluminium anodized running track (Note: Track to be ordered separately)	941.16.915	1500 mm	
	941.16.918	1800 mm	
	941.16.921	2100 mm	
	941.16.924	2400 mm	
	941.16.927	2700 mm	
	941.16.930	3000 mm	

Roller Dimension:

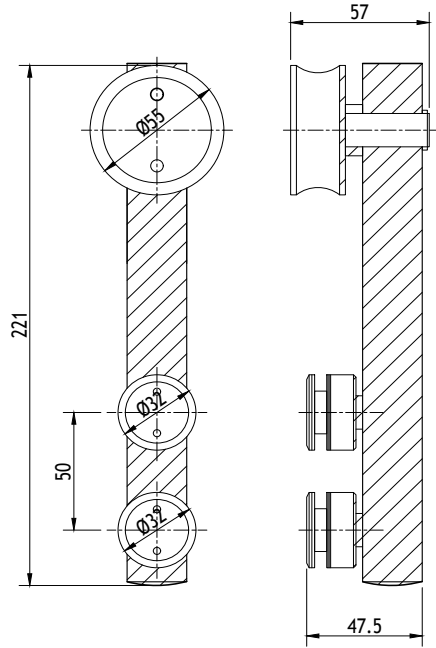

Glass Cutout:

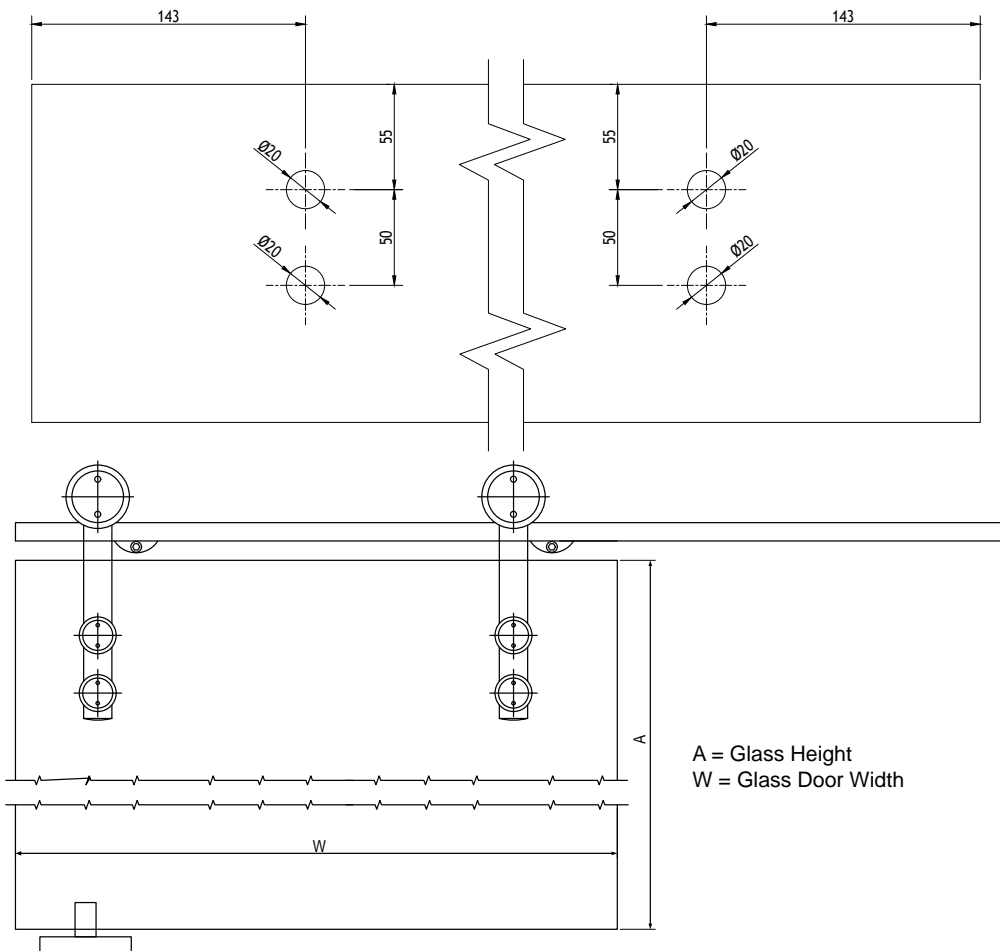

Track Dimension:

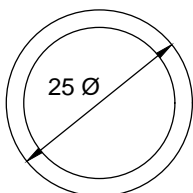

Bottom Guide Cross Section:

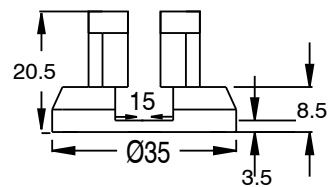

Design 80 SYTL

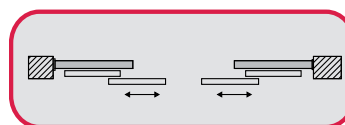
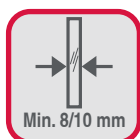
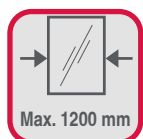

Synchro telescopic sliding system for glass doors.
For simultaneous opening and closing of 4 doors (2 doors telescopic synchronized to the other 2 telescopic doors in opposite direction)

Hardware Specification:

- The opening and closing of 4 doors are parallel and simultaneous
- Maximum total width is 5 meters
- Coupling of profile in order to fit a fixed glass panel on both sides is possible
- **No glass preparation required**



Article No.: 940.99.001

For 4 Panels Sliding door kit consists of:

- 8 Brackets
- 8 Adjustable Stoppers
- 8 Rollers
- 3 Nylon Cables
- 2 Pulleys
- 2 Floating Guides
- 2 Bottom Guides
- 2 Synchro Clamps

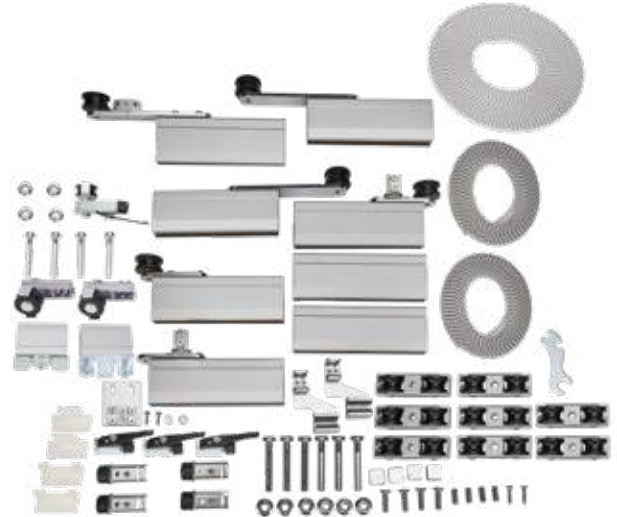

Product Name	Article No.	L mm ← →	
Upper track (Note: Track to be ordered separately)	940.99.932	3000	
Bottom track for fixed glass (Note: Track to be ordered separately)	943.39.815	3000	
Aluminium anodised separator support for trim cover	940.99.080	-	
Trim cover support	940.99.081	-	
Aluminium anodised trim cover	940.99.732	3000	

Order to be based on specifications and requirement of the customer

Design 80 SY

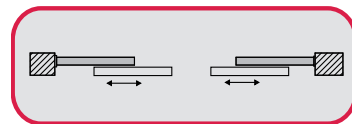
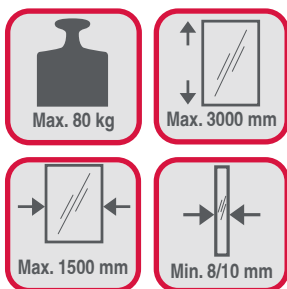

Synchro sliding system for glass doors.
For simultaneous opening of both the doors.

Hardware Specification:

- Ideal for dividers and glass doors up to 80kg weight
- Possible to install in combination with fixed glass
- Simultaneous opening of door is possible because of Synchro system
- **No glass preparation (cut-out) required**



Article No.: 940.99.092
For Synchronised Door

- 4 Rollers with Bracket
- 4 Adjustable Stoppers
- 2 Pulleys
- 1 Synchro Cable & other fittings



Product Name	Article No.	L mm ← →	
Silver anodised aluminium track (Note: Track to be ordered separately)	940.99.930	3000	
Silver anodised aluminium track for fixed glass (Note: Track to be ordered separately)	940.99.830	3000	
Bottom track for fixed glass (Note: Track to be ordered separately)	943.39.815	3000	
Silver anodised aluminium trim cover (Note: Trim cover to be ordered separately)	940.99.730	-	
Aluminium separator (Note: Aluminium separator to be ordered separately)	940.99.093	-	
OPTIONAL			
Trim cover support	940.99.081	-	
Wall support	940.39.031	-	
Profile end trim	943.39.032	-	

Section View:

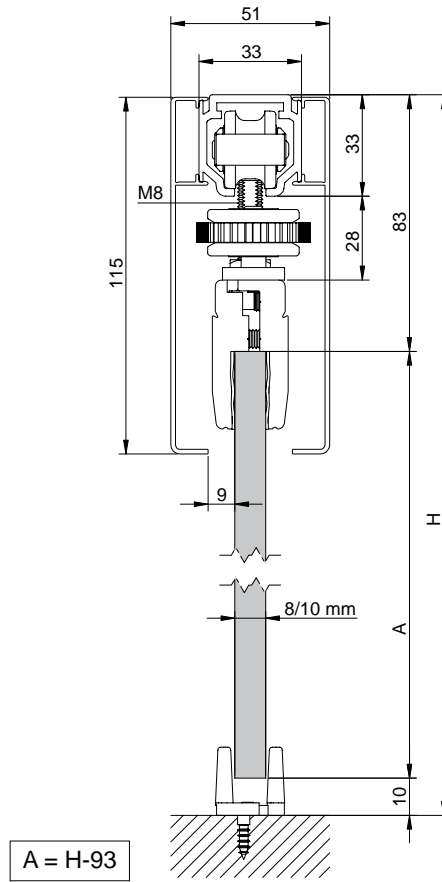

Elevation View:

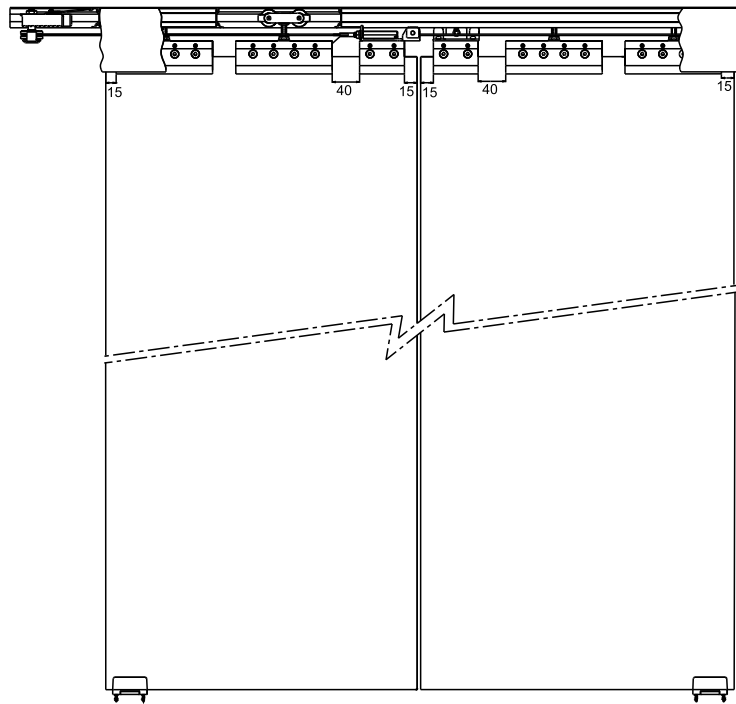

Track Dimension:

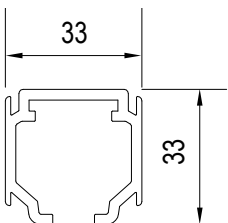

Bottom Guide Cross Section:

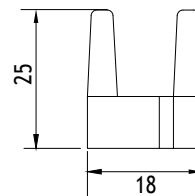

Design 200

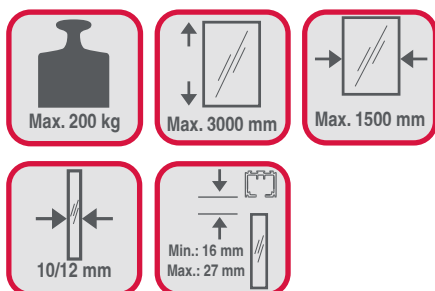
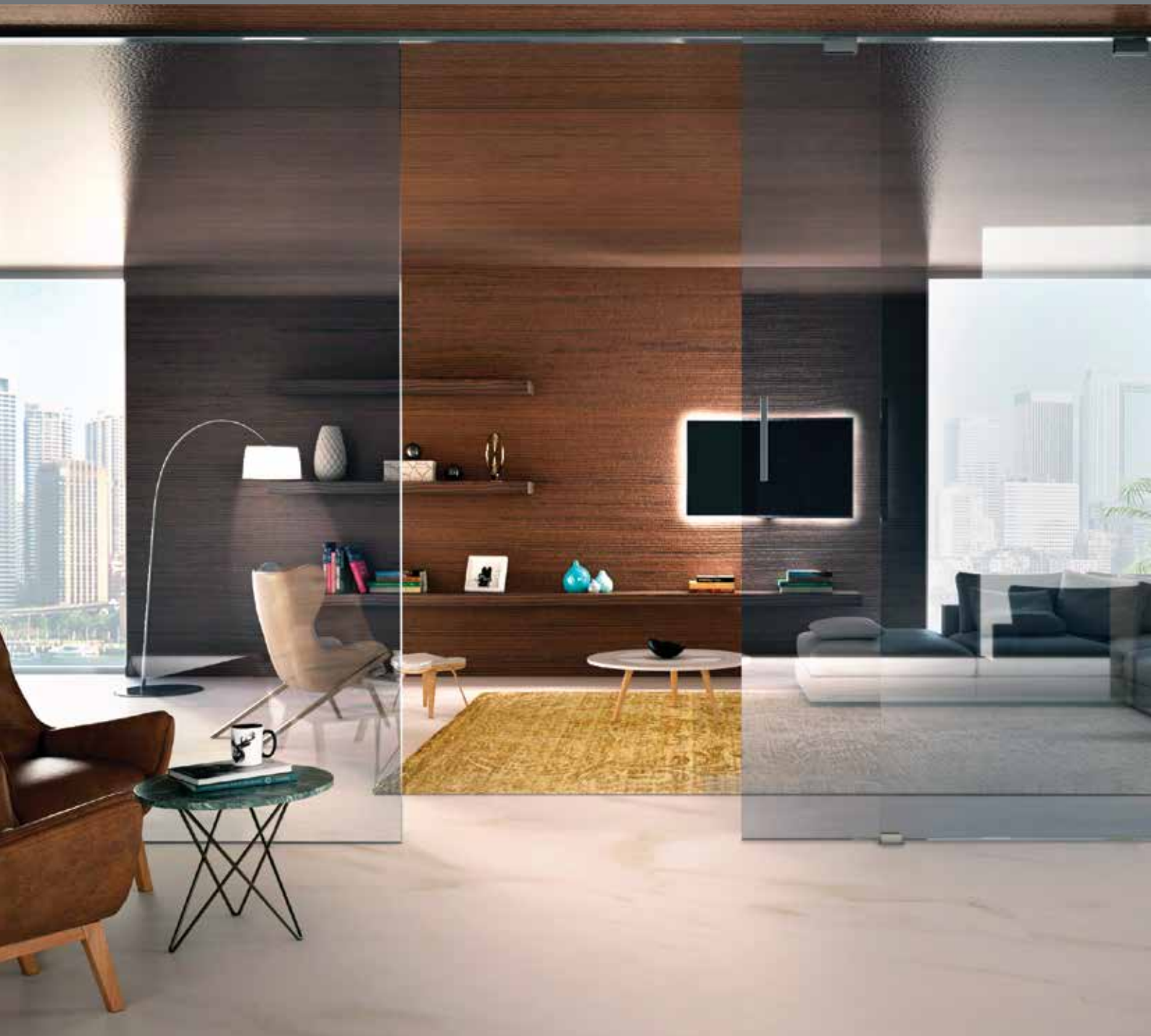

Straight sliding system for glass doors.

Hardware Specification:

- Installation with fixed glass is possible
- System with ball bearing rollers and adjustable stoppers
- Adjustable polyamide bottom guide to allow glass of different thickness
- **No glass preparation (cut-out) required**







Article No.: 942.63.090

Sliding door kit consists of:

- 2 Rollers with Bracket
- 2 Adjustable Stoppers
- 1 Bottom Guide



Product Name	Article No.		
Silver anodised aluminium top track for fixed glass <small>(Note: Track to be ordered separately)</small>	942.63.930	3000 mm	
	942.63.950	5000 mm	
Silver anodised aluminium top track <small>(Note: Track to be ordered separately)</small>	943.39.930	3000 mm	
	943.39.945	4500 mm	
Silver anodized aluminium trim cover <small>(Note: Trim cover to be ordered separately)</small>	942.63.830	3000 mm	
	942.63.850	5000 mm	
Silver anodised aluminium bottom track <small>(Note: Track to be ordered separately)</small>	943.39.815	1500 mm	

Section View:

Wall Mounting

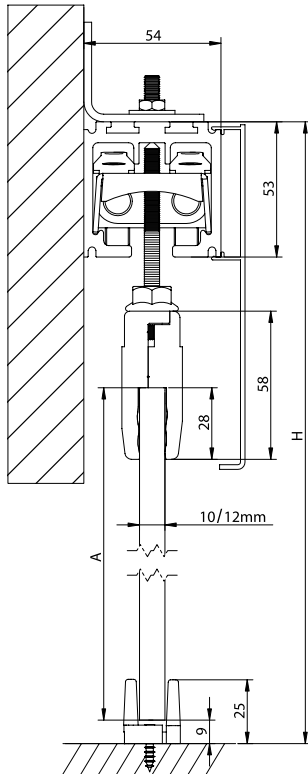

A=H-115

Ceiling Mounting

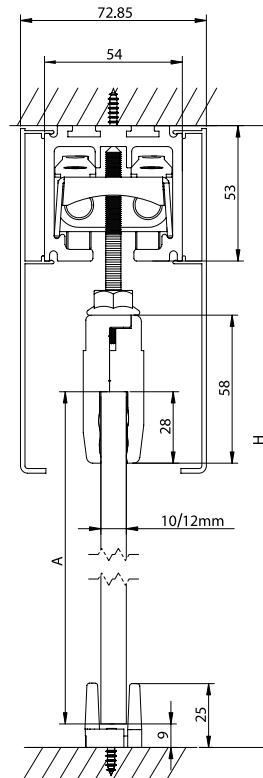

A=H-115

Wall mounting with fixed glass

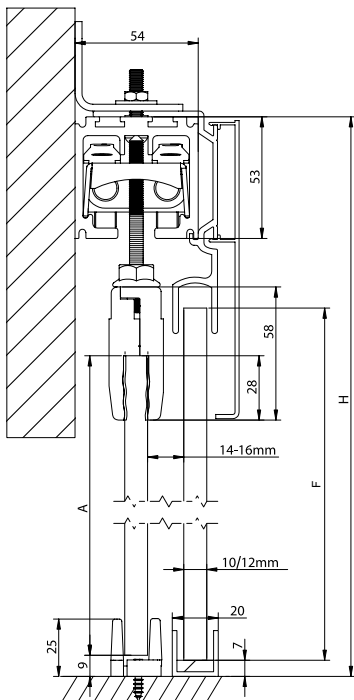

A=H-115
F=H-90

F = Fixed Glass Panel Height

Ceiling mounting with fixed glass

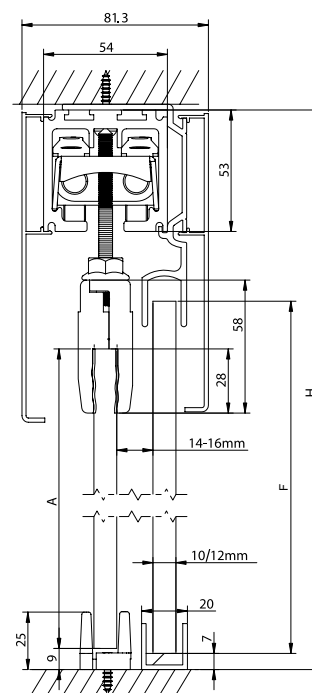

A=H-115
F=H-90

F = Fixed Glass Panel Height

Elevation View:

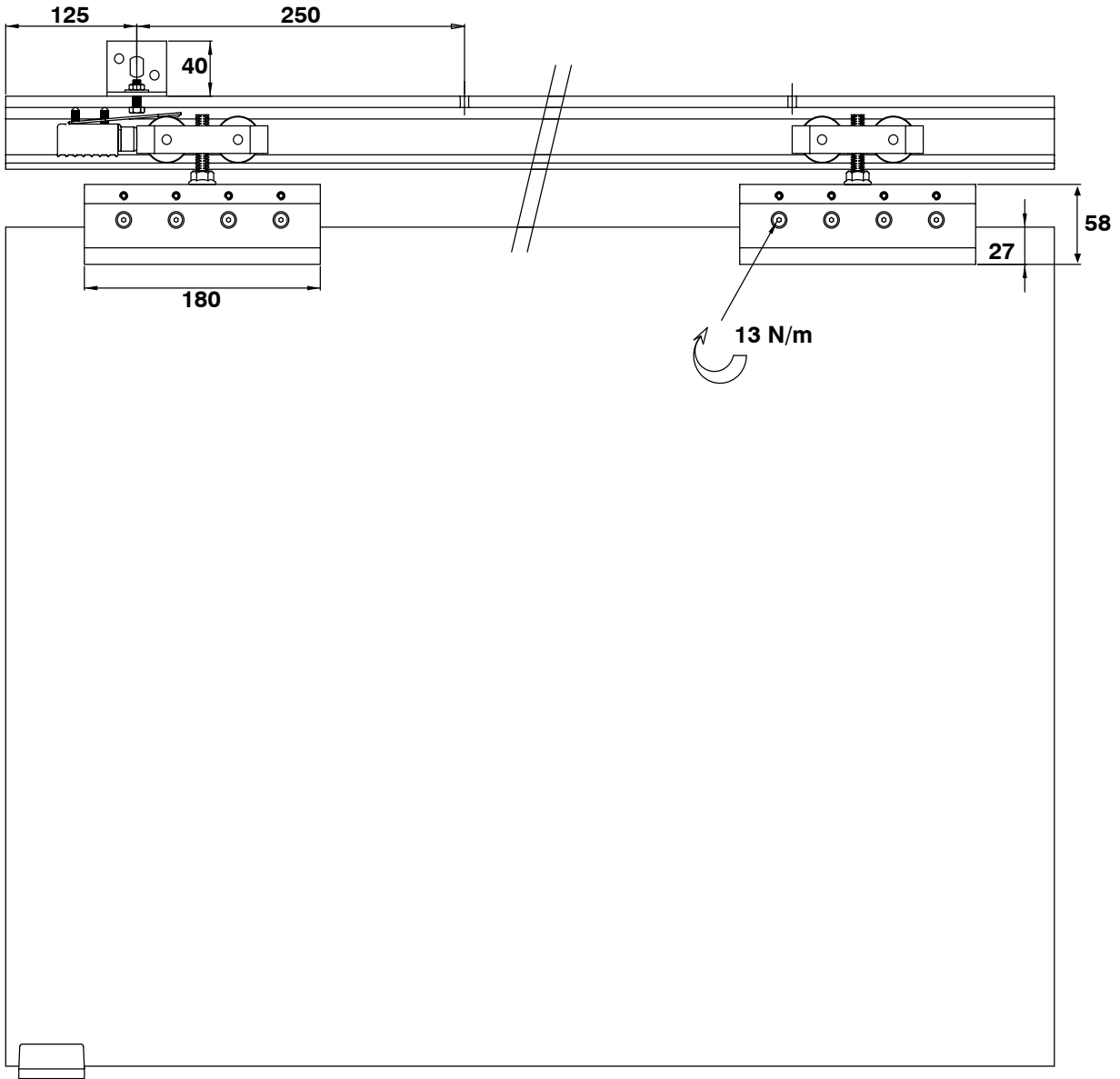

Track Dimension:

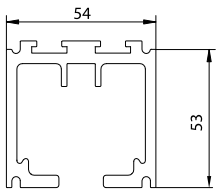

Bottom Guide Cross Section:

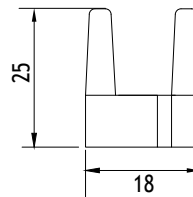

Design 100 SF 101

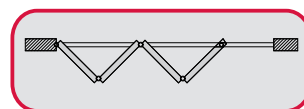
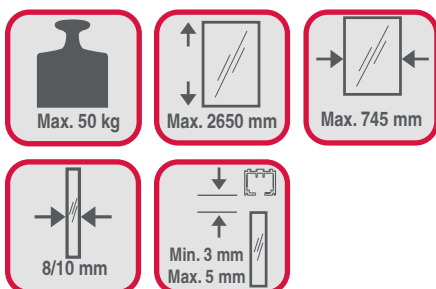











Sliding folding system for glass doors
Only inward opening



Hardware Specification:

- Ideal for interior divider areas
- System of folding glass panels
- Height and width adjustment to prevent unevenness
- For folding sliding panels of 100 kg per pair of panels
- Ball bearings fitted on nylon wheels providing quiet running
- Solid aluminium hinges
- Maximum no. of panels: 6

Sliding System Components:

Product Name	Article No.	
Single hinge roller	943.39.020	
Bottom guide with single hinge	943.39.022	
Central roller double hinge	943.39.023	
Double hinge with base pin	943.39.024	
Central bottom guide double hinge	943.39.026	
Top pivot with hinge	943.39.027	
Bottom hinge with pivot	943.39.028	
Bottom hinge with bolt	943.39.029	
OPTIONAL		
Optional Double Hinge 'A' Central*	943.39.025	
Optional Double Hinge 'B' Central*	943.39.030	

*For doors higher to the height advised sizes (2400 mm) it is necessary to install patch-hinges

Product Name	Article No.		
Silver anodized aluminium top track (Note: Track to be ordered separately)	943.39.930	3000	
	943.39.945	4500	
Silver anodized aluminium bottom track (Note: Track to be ordered separately)	943.39.830	3000	
	943.39.845	4500	

Glass Cut-out Details:

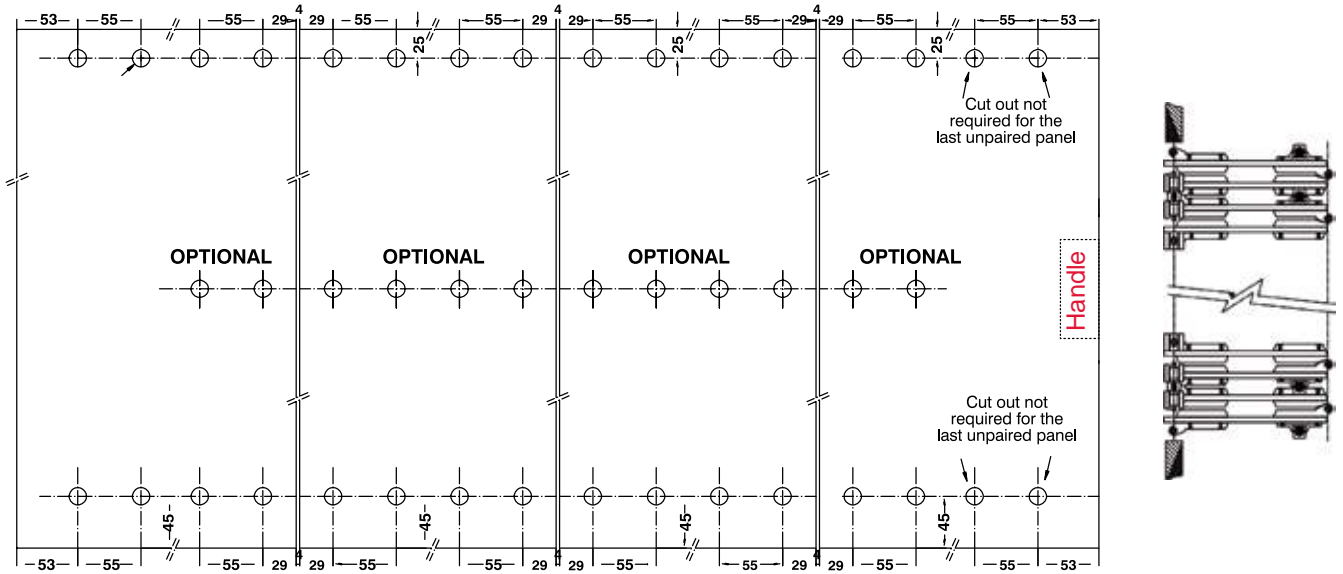

Note: The first & last panels are 24 mm bigger in width than others.
 Please refer to the cutout drawing before glass preparation or check with Hafele representative.
 Cut-out for handle needs to be made as per the handle chosen.

Installation: For 2/4/6 Panels

For 2 Panels For 4 Panels For 6 Panels

A = Max 1500 mm	A = Max 3000 mm	A = Max 4500 mm
B = Max 3000 mm	B = Max 6000 mm	B = Max 9000 mm

For panels higher than recommended size, it is necessary to use optional central hinges

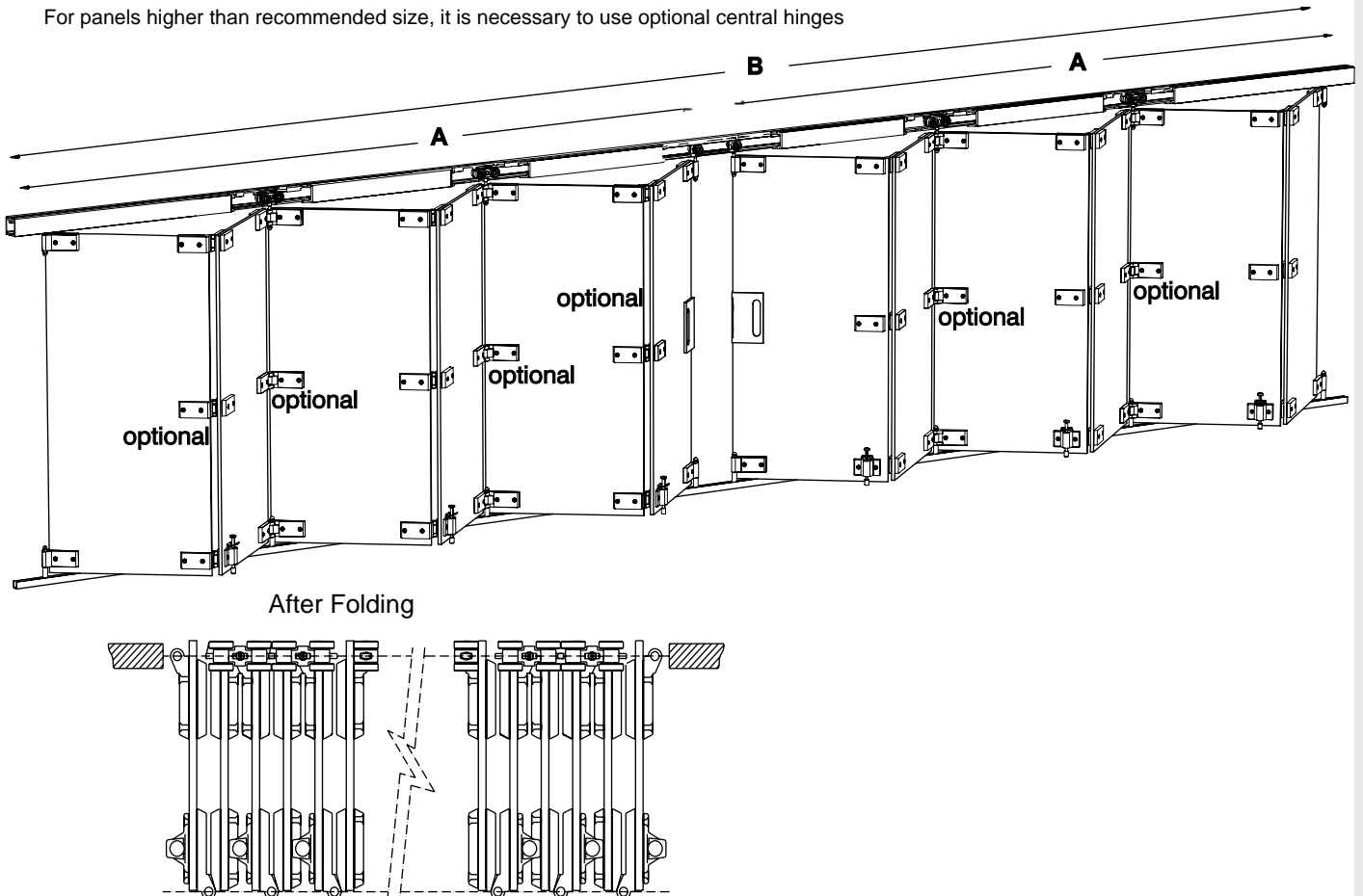

Installation: **For 2/4/6 Panels**

For 3 Panels

For 5 Panels

A = Max 2250 mm
B = Max 4500 mm

A = Max 3750 mm
B = Max 7500 mm

For panels higher than recommended size, it is necessary to use optional central hinges

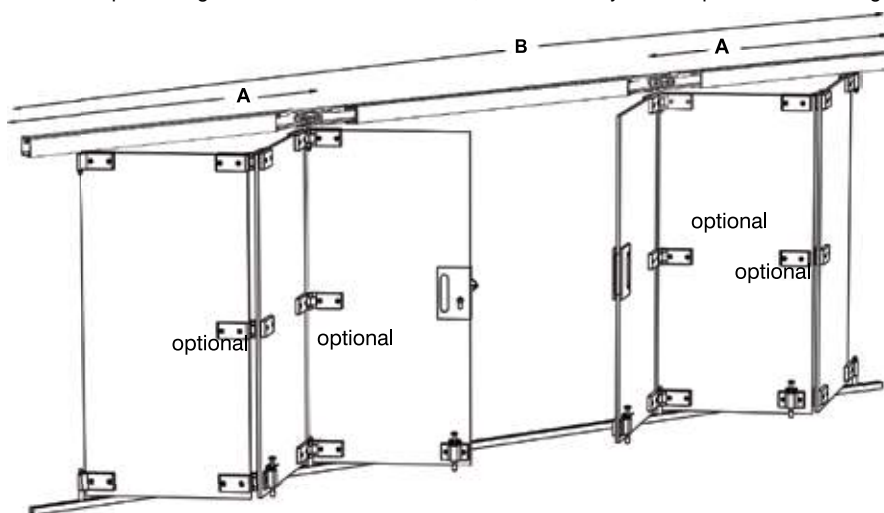

After Folding

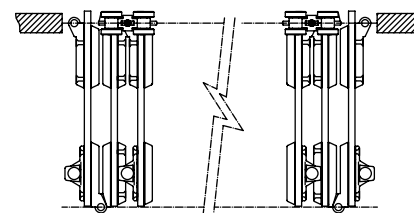

Sliding System Components:

Article No.	2 Panel		3 Panel		4 Panel		5 Panel		6 Panel	
	A (2 Panels)	B (2+2 Panels)	A (3 Panels)	B (3+3 Panels)	A (4 Panels)	B (4+4 Panels)	A (5 Panels)	B (5+5 Panels)	A (6 Panels)	B (6+6 Panels)
943.39.020	1	2	—	—	1	2	—	—	1	2
943.39.022	1	2	—	—	1	2	—	—	1	2
943.39.023	—	—	1	2	1	2	2	4	2	4
943.39.024	1	2	1	2	2	4	2	4	3	6
943.39.025	—	—	1*	2*	1*	2*	2*	4*	2*	4*
943.39.026	—	—	1	2	1	2	2	4	2	4
943.39.027	1	2	1	2	1	2	1	2	1	2
943.39.028	1	2	1	2	1	2	1	2	1	2
943.39.029	—	—	1*	2*	—	—	1	2	—	—
943.39.030	1 or 2*	2 or 4*	1 or 2*	2 or 4*	2 or 4*	4 or 8*	2 or 4*	4 or 8*	3 or 6*	6 or 12*

*Note: Only to use if panel size is above 2400 mm, otherwise not applicable.

Section View:

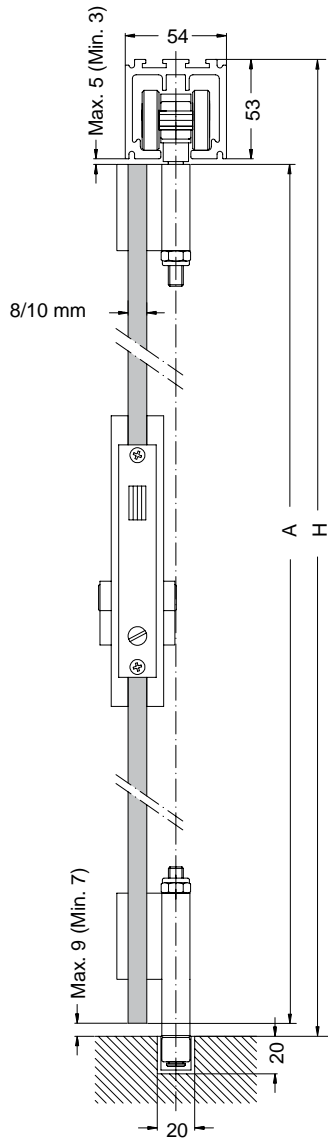

$A \text{ Min.} = H - 67$ $A \text{ Max.} = H - 63$
--

Track Dimension:

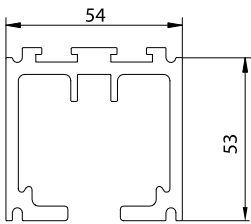

Bottom Track Cross Section:

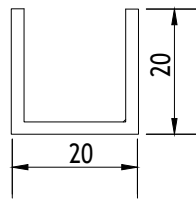

Design Telescopic Progressive 80

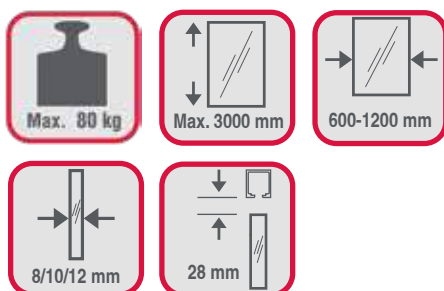

Telescopic progressive sliding system for glass doors

Hardware Specification:

- Top hung straight sliding system for glass doors in internal spaces
- High quality parts and components manufactured in Europe
- Maximum 3 doors on one side are allowed
- When one door is pushed or pulled, the other doors move simultaneously in tandem
- The floating bottom guides are installed on the sliding doors keeping them hidden when the doors are parked. This leaves a completely free passage
- The roller and hanger are made of Zamak which reduces the risk of rusting and damage
- Ground shielded ball bearings inside the rollers enable silent and smooth operation
- Mechanism is available for both left hand and right hand doors
- **No glass preparation (cut-out) required**



Kit for two doors - **941.27.436**

Sliding door kit consists of:

- 4 Rollers
- 4 Carriage set
- 4 Stoppers
- 1 Fixed bottom guide
- 1 Floating bottom guide
- 2 Pulley
- 1 Belt
- 1 Supporting Brackets and accessories

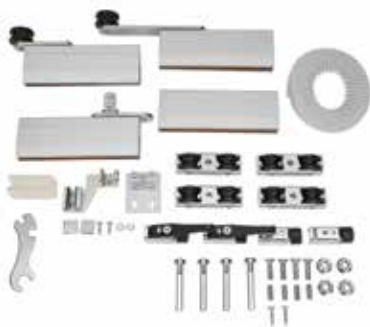



Kit for three doors - **941.27.437**

Sliding door kit consists of:

- 6 Rollers
- 6 Carriage set
- 6 Stoppers
- 1 Fixed bottom guide
- 2 Floating bottom guides
- 4 Pulleys
- 2 Belts
- 1 Supporting Brackets and accessories



Product Name	Article No.		
Aluminium anodized top track (Note: Track to be ordered separately)	940.99.604	3600 mm	

THE MOVEMENT OF THE DOORS
Classic 80 Telescopic Progressive

Three Doors

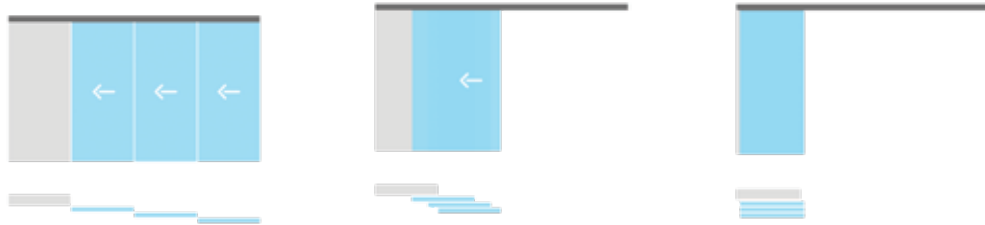

Two Doors

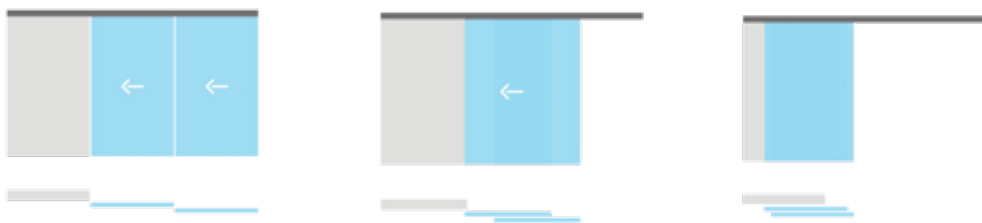

INSTALLATION POSSIBILITIES FOR TELESCOPIC PROGRESSIVE SYSTEMS

For Two Doors
Levelled System

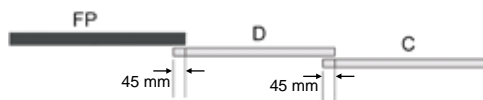

Overlap System

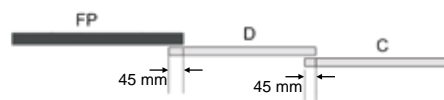

For Three Doors
Levelled System

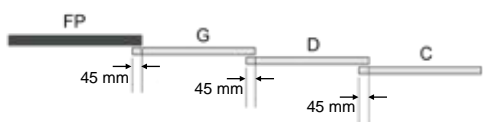

Overlap System

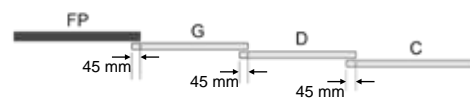

Note 1: The fixed panel can be wood or glass for both the Telescopic Progressive systems. The overlap system is useful when you want to install handles on both the sides of the exterior door

Installation

Design 80 Telescopic Progressive

A = Height of Sliding Door; H = Total Opening Height

For Two Doors
Section View:

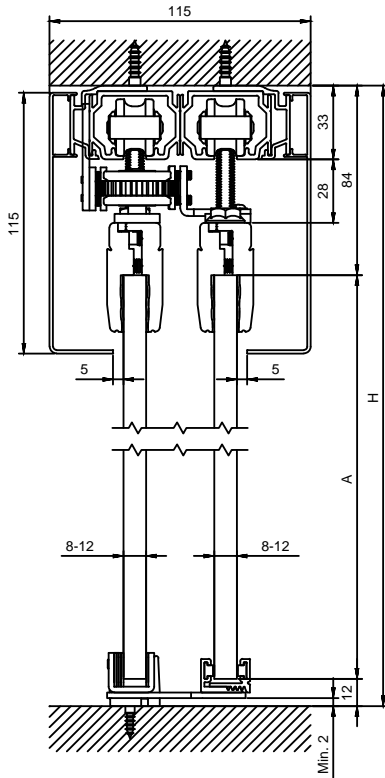

$A = H - 96$

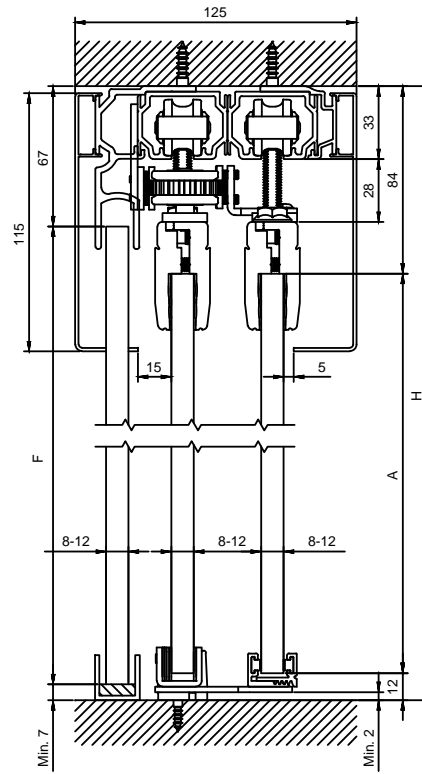

$A = H - 96$ $F = H - 74$
F = Fixed Glass Height

LEFT

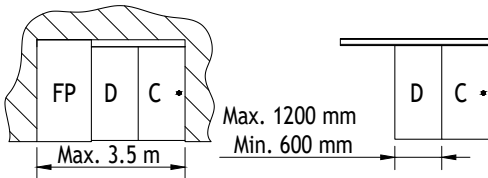

Leveled

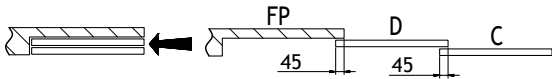

Overlap

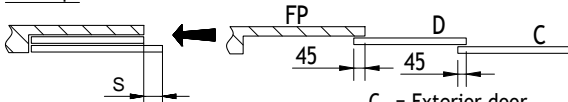

C = Exterior door
D = Interior door
FP = Fixed sheet

RIGHT

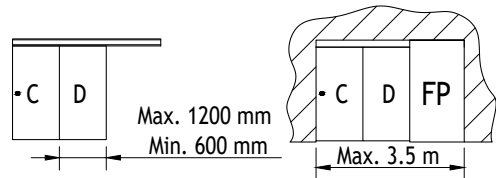

Leveled

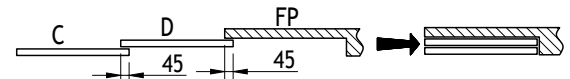

Overlap

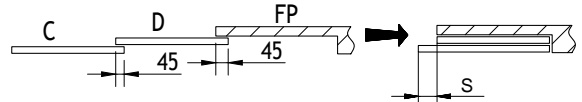

Track Dimension:

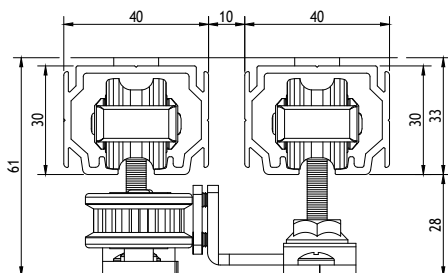

Floating Guide Cross Section:

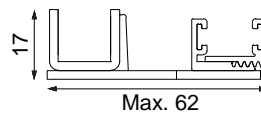

Section View:

For Three Doors:

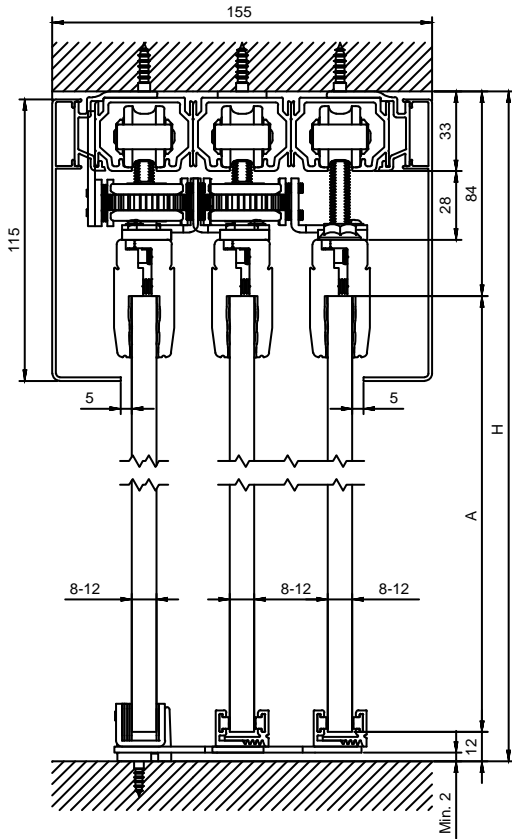

A = H-96

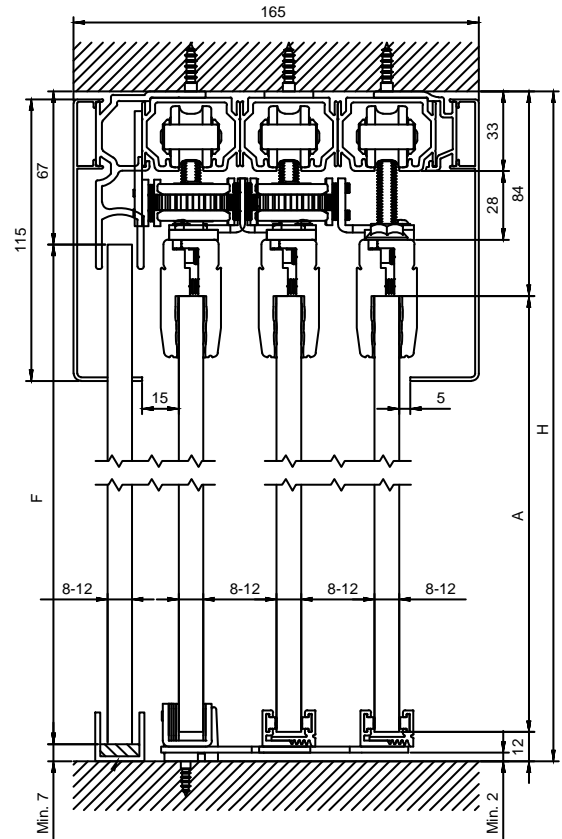

A = H-96

F = H-74

F = Fixed Glass Height

LEFT

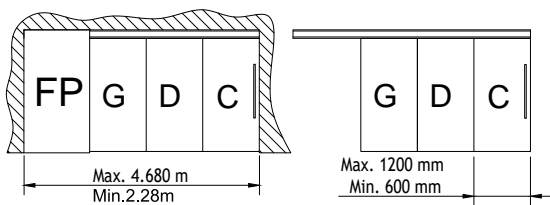

Leveled

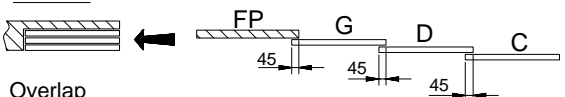

Overlap

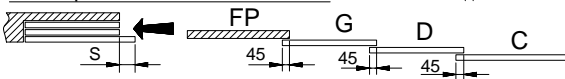

C = Exterior door
D = Central door

RIGHT

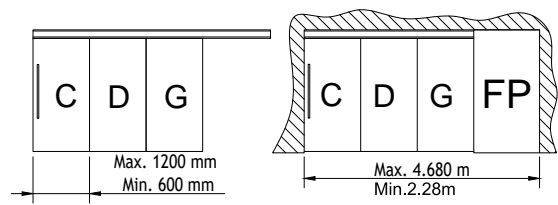

Leveled

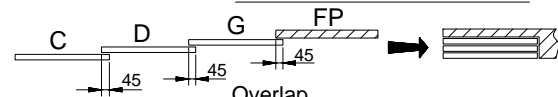

Overlap

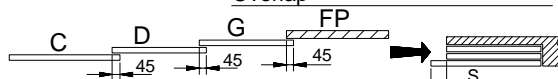

G = Interior door
FP = Fixed sheet
S = Overlap width of exterior door

Track Dimension:

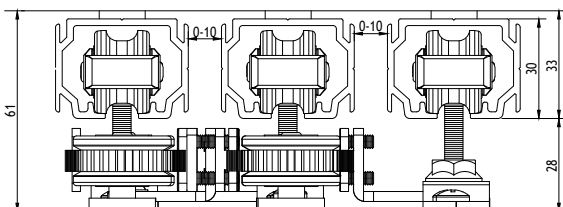

Floating Guide Cross Section:

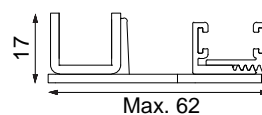

Eclipse 40



Sliding folding stacking system for glass door.

Hardware Specification:

- Ideal for dividers and glass doors
- Right or left stackable parking system
- Mobile, practical and versatile closing system
- System can be installed with or without lower profile
- High sealing system
- For 6, 8 and 10mm glass

Order to be based on specifications and requirement of the customer

Section View:

Application 1

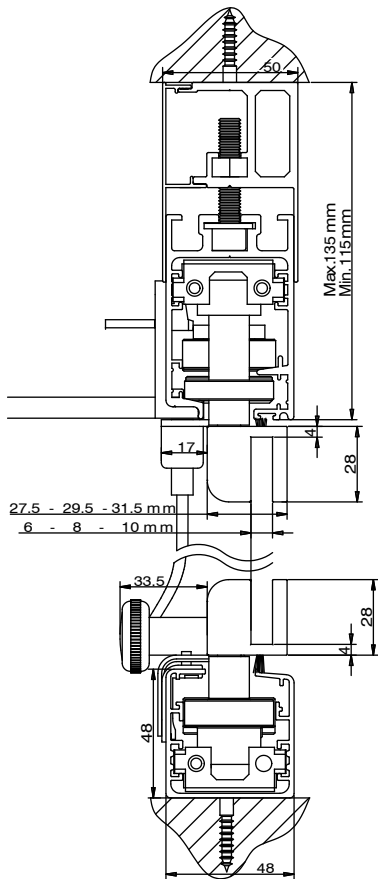

Track Dimension:

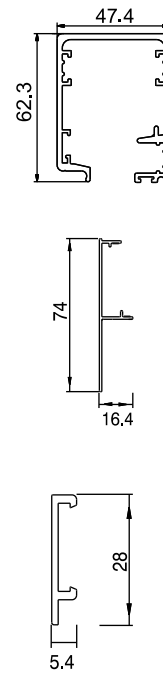

Eclipse 150

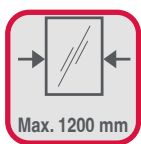

Special Order

Sliding folding stacking system for glass door.
Also available in Timber

Hardware Specification:

- Ideal for dividers and glass doors
- Ideal for large areas and closing elements
- 90° perpendicular parking system
- No lower profile
- For 10mm and 12mm glass
- Unlimited installation width

Order to be based on specifications and requirement of the customer

Section View:

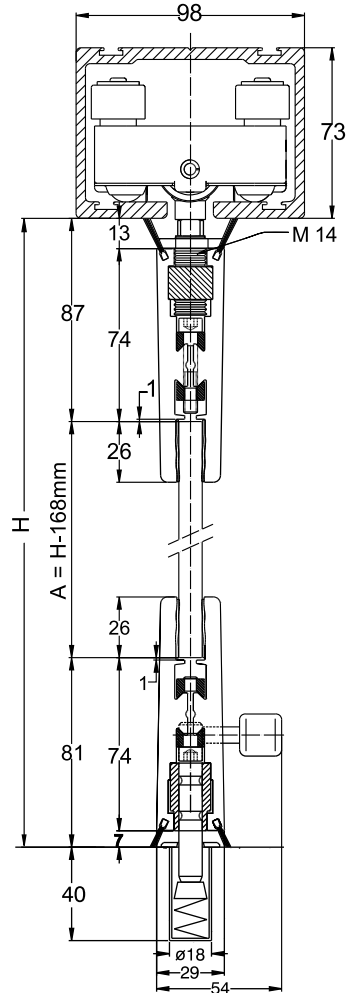

Elevation View:

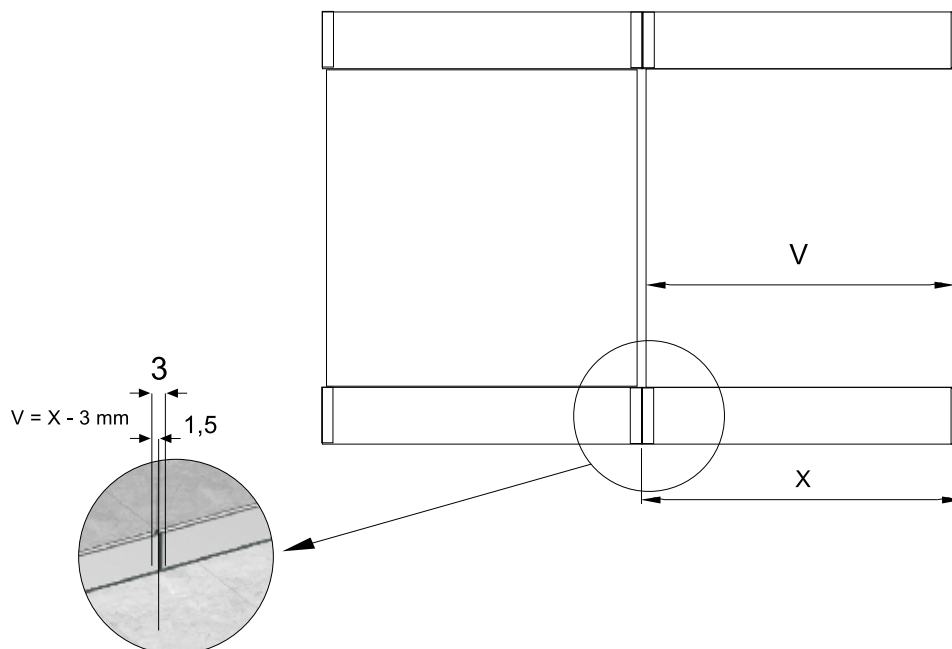





WARDROBE SLIDING SYSTEMS



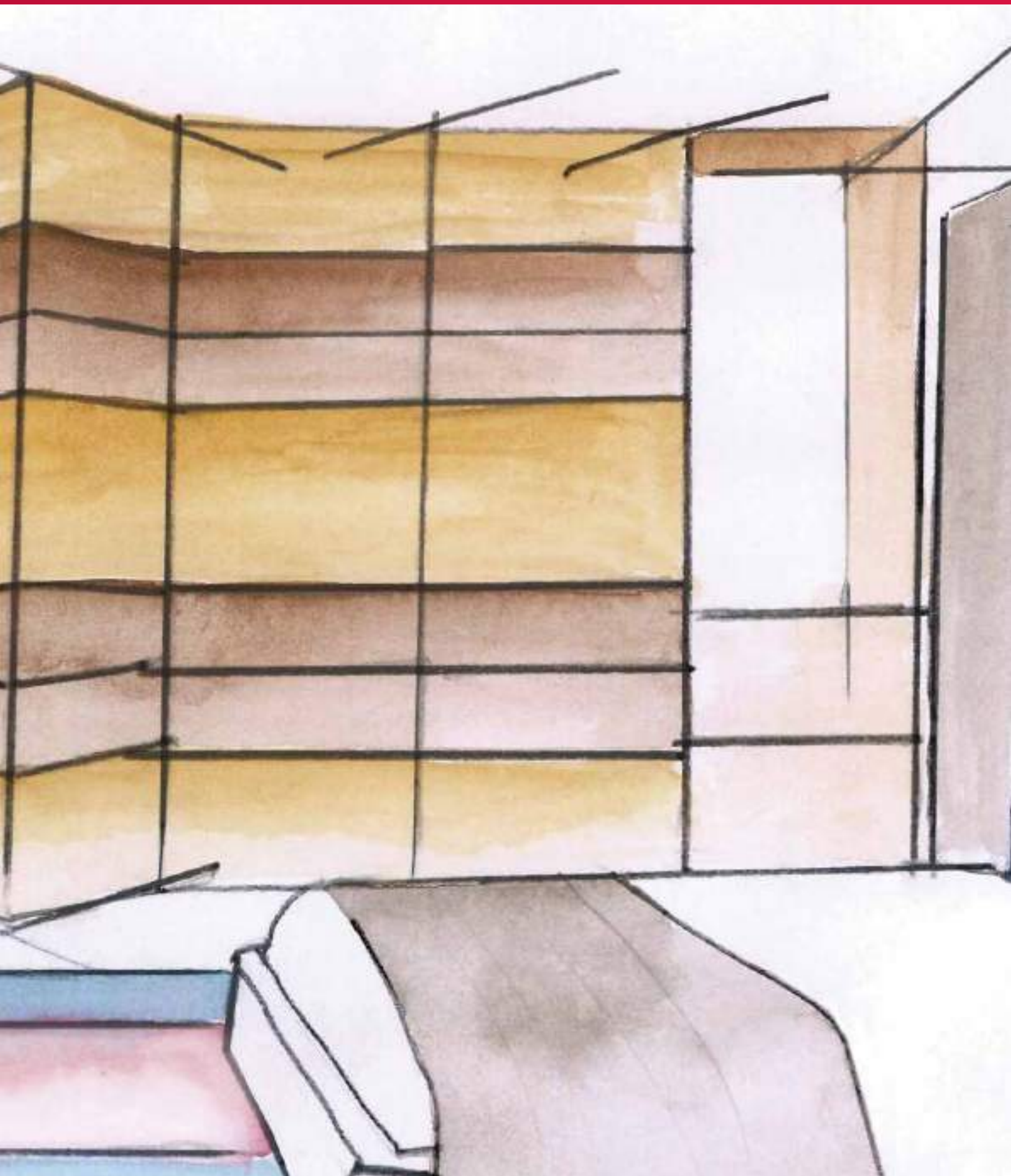

Classic IF 45

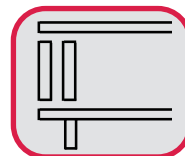
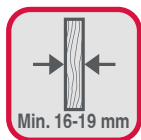
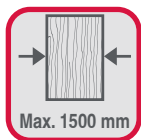
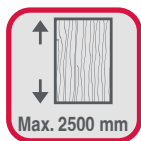

Straight sliding system for wooden wardrobe and furniture doors.

For Smuso, Please refer to Page No.: 187

Hardware Specification:

- Vertical adjustment mechanism which enable adjustment up to 6 mm
- For doors with thickness of 16 and 19 mm
- Rolling system with ball bearing wheels
- For single or double guide applications

Note: If you place the order using the individual components (as listed below), please order the track separately. Alternately if you place the order using the BOM Articles (mentioned in the BOM LIST table), the track is included.







Article No.: 405.21.100

Sliding door kit consists of:

- 2 Rollers with Bracket
- 1 Bottom Guide



Product Name	Article No.		
Silver anodized aluminium top single track	405.21.603	3000 mm	
Silver anodized aluminium top double track	405.21.613	3000 mm	
Brake stop (Note: Brake stop to be ordered separately)	405.21.300	-	

BOM LIST (Track Included)	
Description	Article No.
Classic IF 45 with single 3m track for two door	401.29.004
Classic IF 45 with double 3m track for two door	401.29.005
Classic IF 45 with single 3m track and Smuso for 1 door	405.21.000
Classic IF 45 with double 3m track and Smuso for 2 door	405.21.001

**Single Door
Section View:**

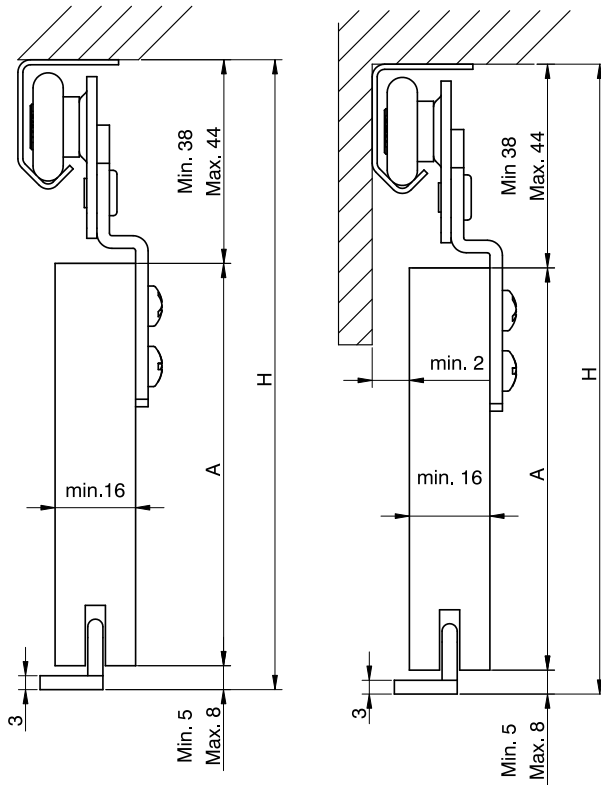

A Min. = H - 52 (max.)
A Max. = H - 43 (min.)

Track Dimension:

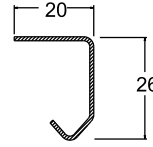

Bottom Guide Cross Section:

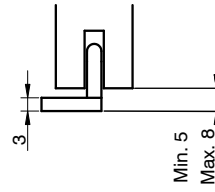

**Double Door
Section View:**

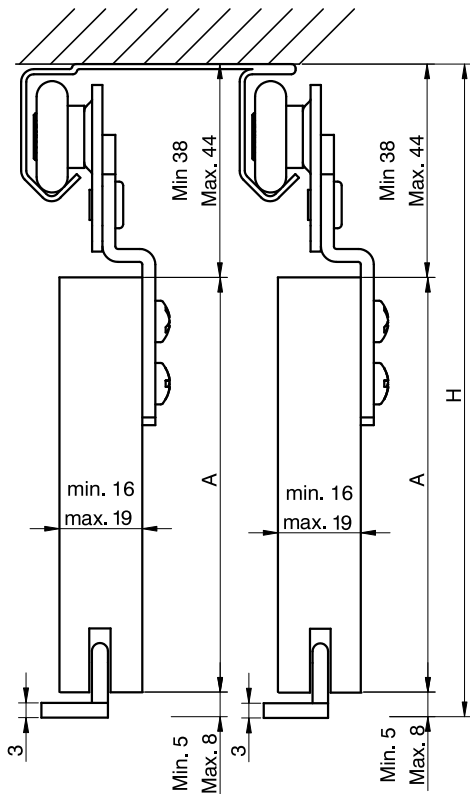

Track Dimension:

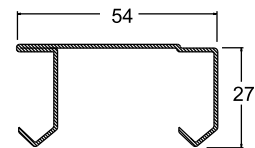

Bottom Guide Cross Section:

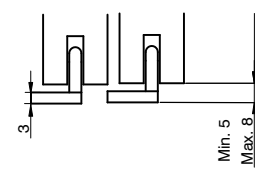

Carcass Drawing:

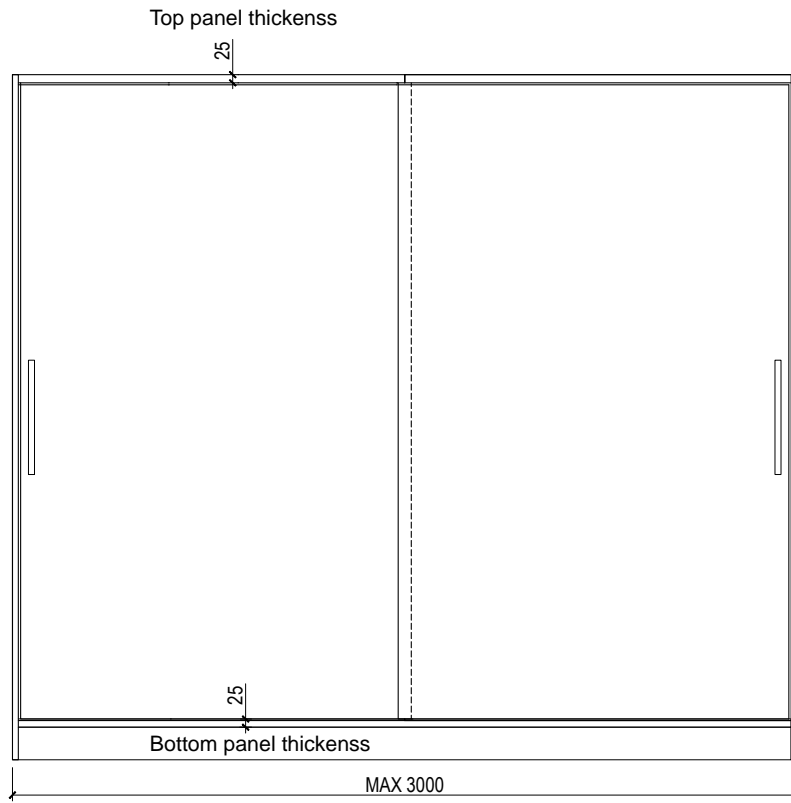

ELEVATION

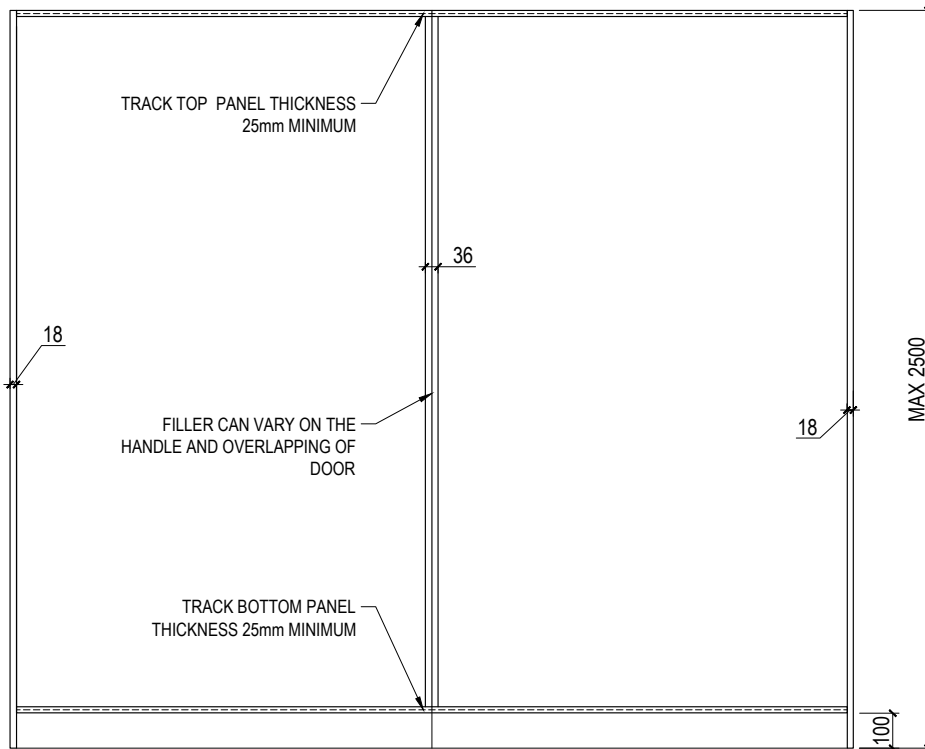

INTERNAL ELEVATION

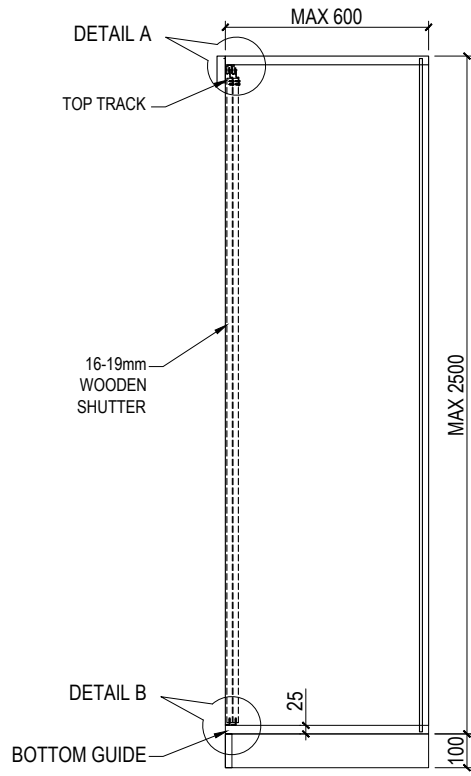

SECTION

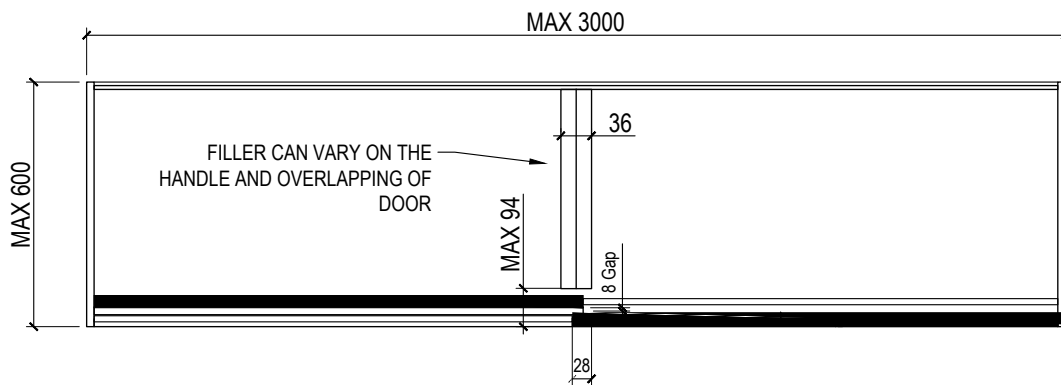
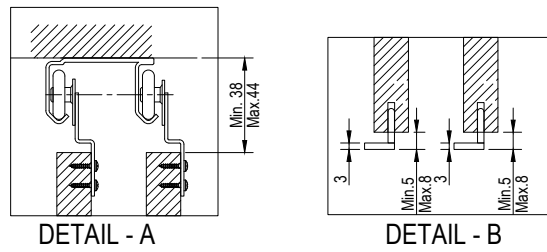

*Carcass Dimension only for reference

PLAN

Classic IF 50

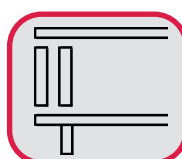
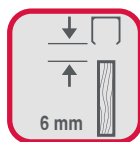
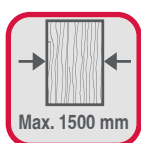
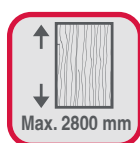
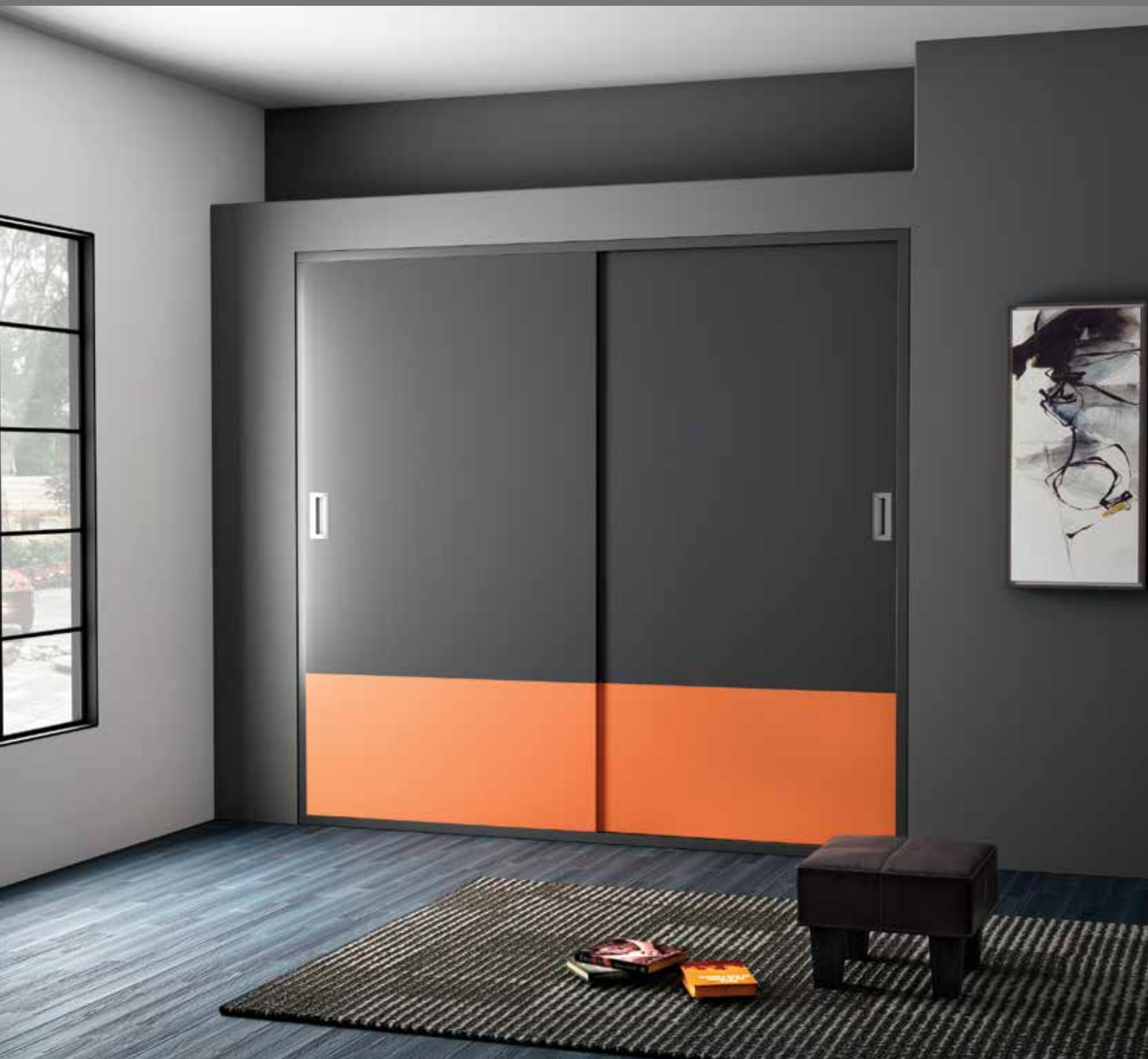

Infront sliding system for wooden wardrobe and furniture doors

For Smuso, Please refer to Page No.: 187

Hardware Specification:

- Bottom running rollers for smooth and effortless movement
- The pre-drilled holes are oblong in shape to provide for adjustability and alignment of panels
- The top and bottom (common) tracks are extruded anodized Aluminium profiles for smooth movement of the roller
- Very easy to install and ensures running stability for bottom running sliding

Note: If you place the order using the individual components (as listed below), please order the track separately. Alternately if you place the order using the BOM Articles (mentioned in the BOM LIST table), the track is included.





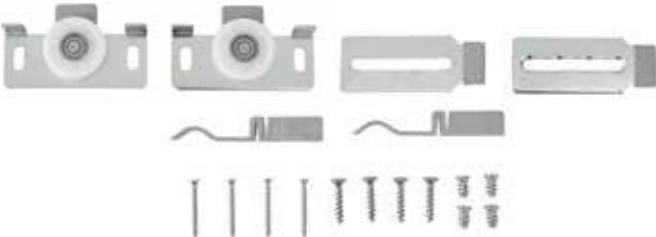

Complete accessories set for 1 door
Article No.: 404.24.000
 Sliding door kit consists of:

- 2 Runners
- 2 Bottom Guides
- 2 End Stoppers



Product Name	Article No.		
Extruded aluminium track	404.24.901	3000 mm	

BOM LIST (Track Included)	
Description	Article No.
TYPE A = Track width 1500 with 2 panels	
Fitting set Classic IF 50 (Slyde 50) kit with extruded aluminium track for 2 doors 3000 mm track - 2 pcs. each	401.29.006
Consisting of	
Fitting set Classic IF 50 (Slyde 50) kit for 1 door - 2 sets	404.24.000
extruded aluminium track profile - 3000 mm- 2 pcs.	404.24.901
TYPE B = Track width 2000 with 2 panels	
Fitting set Classic IF 50 (Slyde 50) kit with extruded aluminium track for 2 doors 3000 mm track - 3 pcs. each	401.29.007
Consisting of	
Fitting set Classic IF 50 (Slyde 50) kit for 1 door - 2 sets	404.24.000
Extruded Aluminium Track Profile - 3000 Mm- 3 Pcs.	404.24.901
TYPE C = Track width 2000 with 3 panels	
Fitting set Classic IF 50 (Slyde 50) kit with extruded aluminium track for 3 doors 3000 mm track - 3 pcs. each	401.29.008
Consisting of	
Fitting set Classic IF 50 (Slyde 50) kit for 1 door - 3 sets	404.24.000
Extruded aluminium track profile - 3000 mm- 3 pcs.	404.24.901

Elevation:

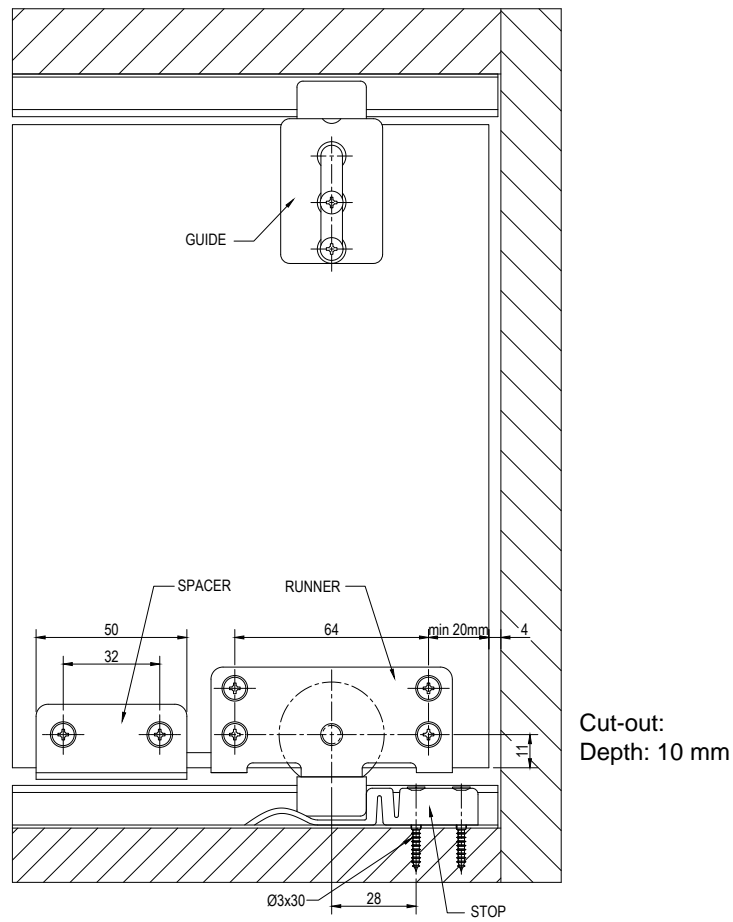

Section:

A, B, C, D, E : TOP AND BOTTOM COMMON TRACK

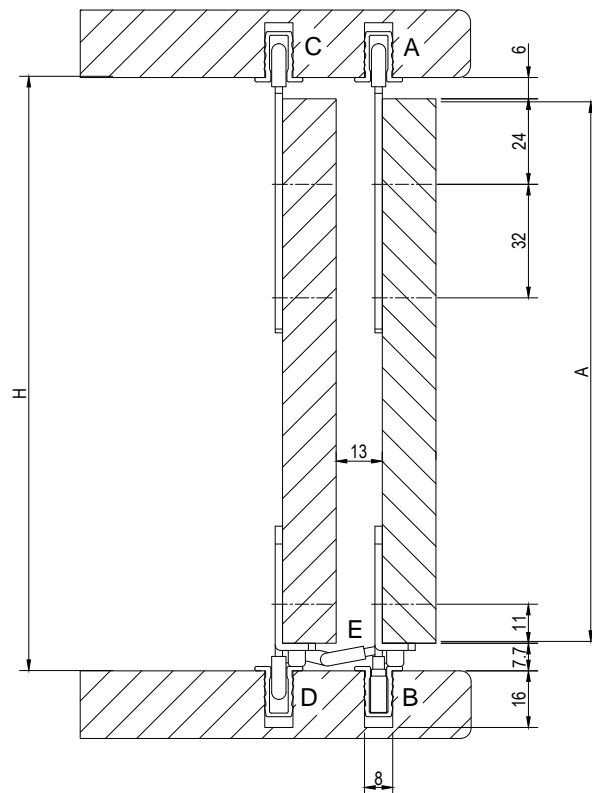

$A = H - 14.7$

Carcass Drawing:

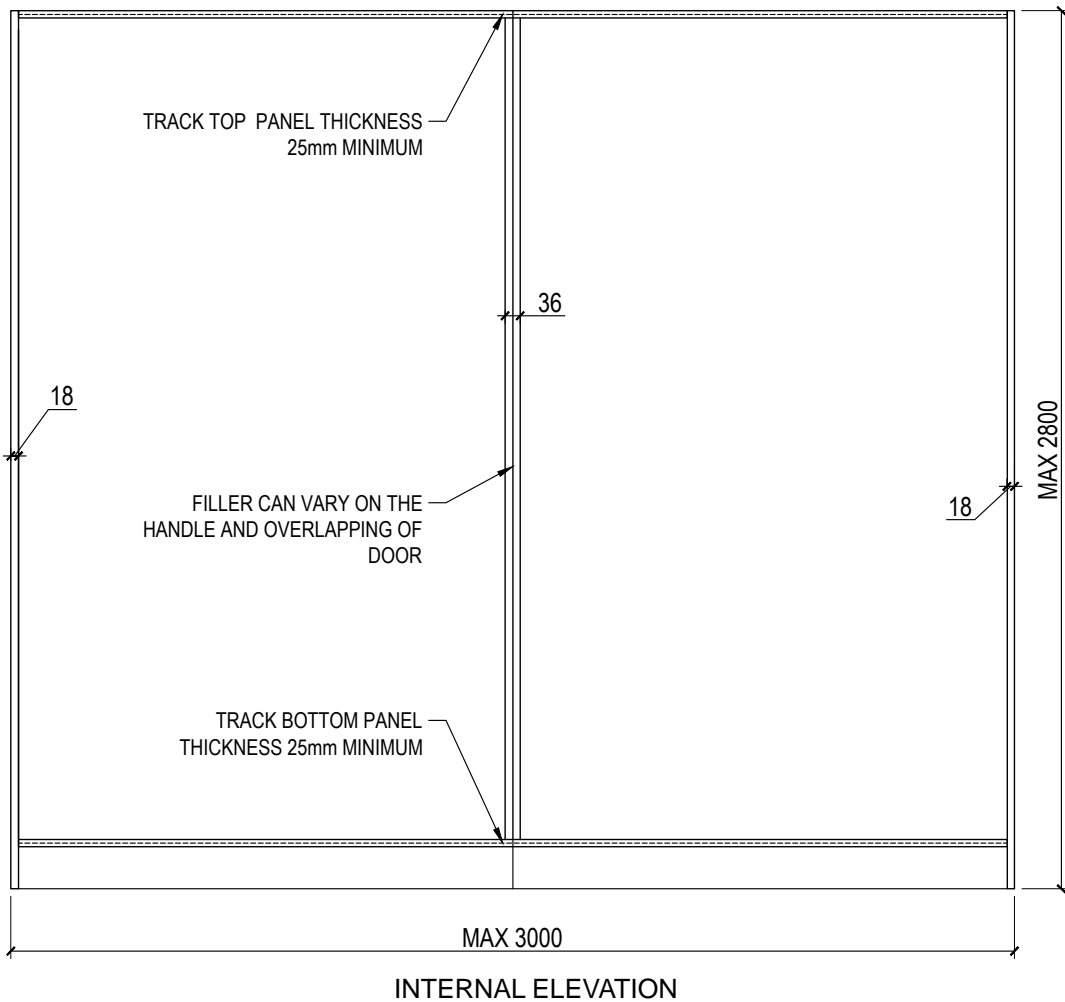
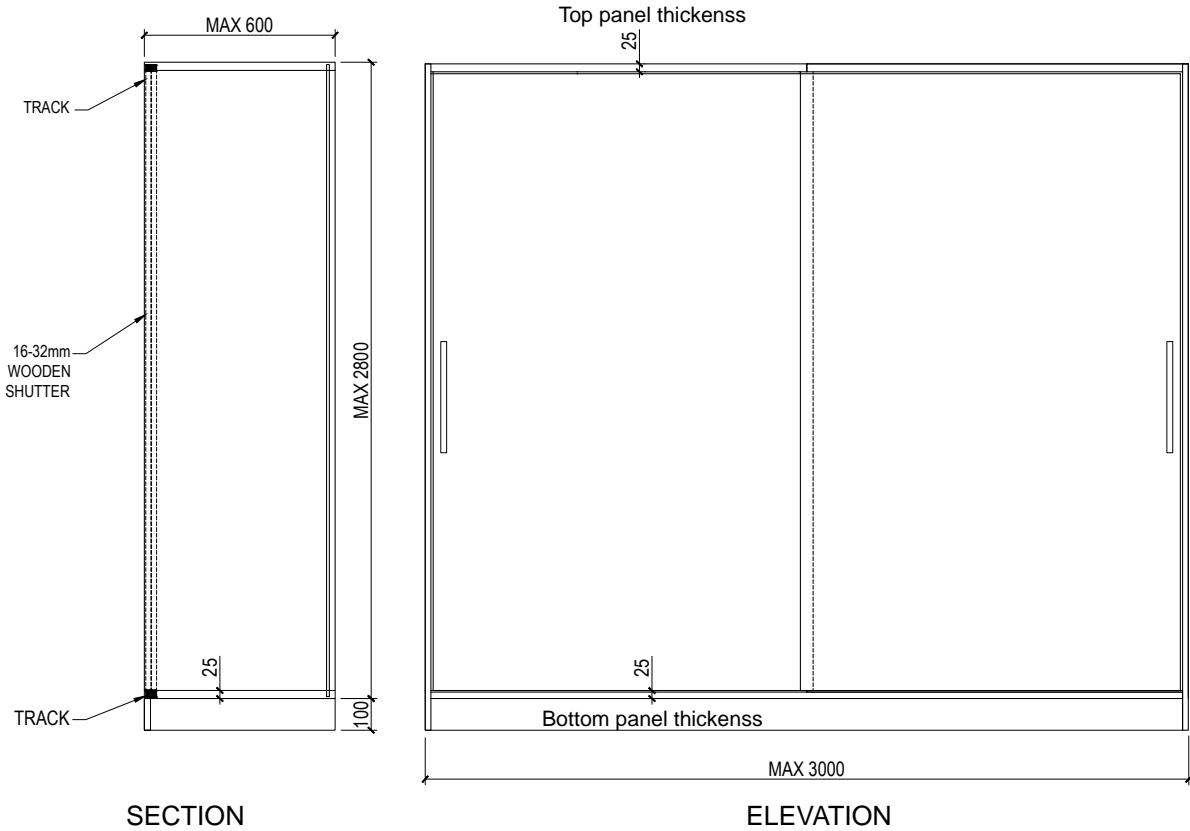

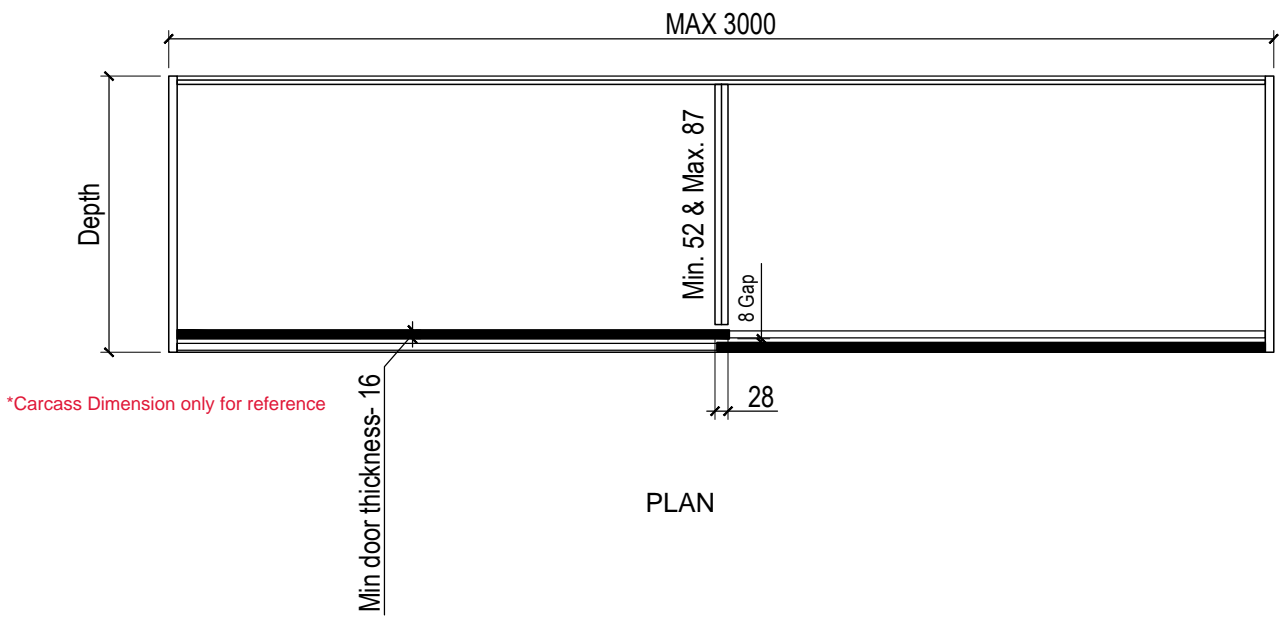

NEW Classic 50 VF S
(ST - 18)

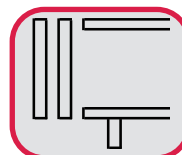
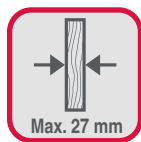
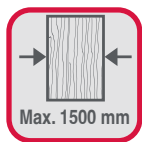
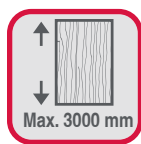

Vorfront sliding system for wooden wardrobe and furniture doors.

For Smuso, Please refer to Page No.: 187

For E-Drive please refer to Page No.: 239

Hardware Specification:

- Smooth and effortless sliding doors
- Easy installation
- Suitable for 2 door and 3 door applications

Note: If you place the order using the individual components (as listed below), please order the track separately. Alternately if you place the order using the BOM Articles (mentioned in the BOM LIST table), the track is included.

 **Article No.: 400.51.125**
For 2 Doors - Sliding door kit consists of:

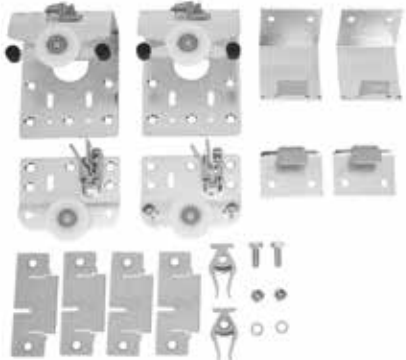

- 2 Running Gears with Ball Bearing
- 1 Running Gear for Inner Door
- 1 Running Gear with Pins
- 2 End Stoppers
- 2 Bottom Guides for Inner Door
- 2 Bottom Guides Adjustable
- 4 Clips for Guide
- 2 End Stops
- 2 Support Blocks
- Central Stop

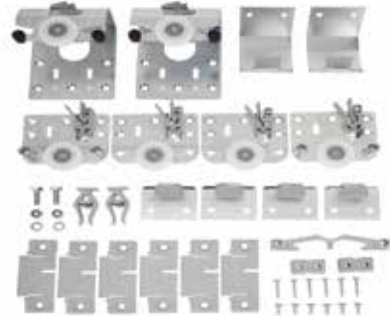

 **Article No.: 400.51.129**
For 3 Doors - Sliding door kit consists of:

- 2 Running Gears with Ball Bearing
- 2 Running Gears for Inner Door
- 2 Running Gears with Pins
- 2 End Stoppers
- 4 Bottom Guides for Inner Door
- 2 Bottom Guides Adjustable
- 6 Clips for Guide
- 2 End Stops
- 2 Support Blocks
- 1 Central Stop



Product Name	Article No.		
Silver anodized aluminium top track	400.52.026	2500 mm	
	400.52.036	3500 mm	
Silver anodized aluminium bottom track	400.52.954	2500 mm	
	400.52.955	3500 mm	

BOM LIST (Track Included)	
Description	Article No.
Classic 50 VF S (ST-18) with 2.5 m track	400.51.501
Classic 50 VF S (ST-18) with 3.5 m track	400.51.502

For 3 Doors: Order to be based on specifications and needs of the customer.

Section View:

Installation dimensions with guide rail

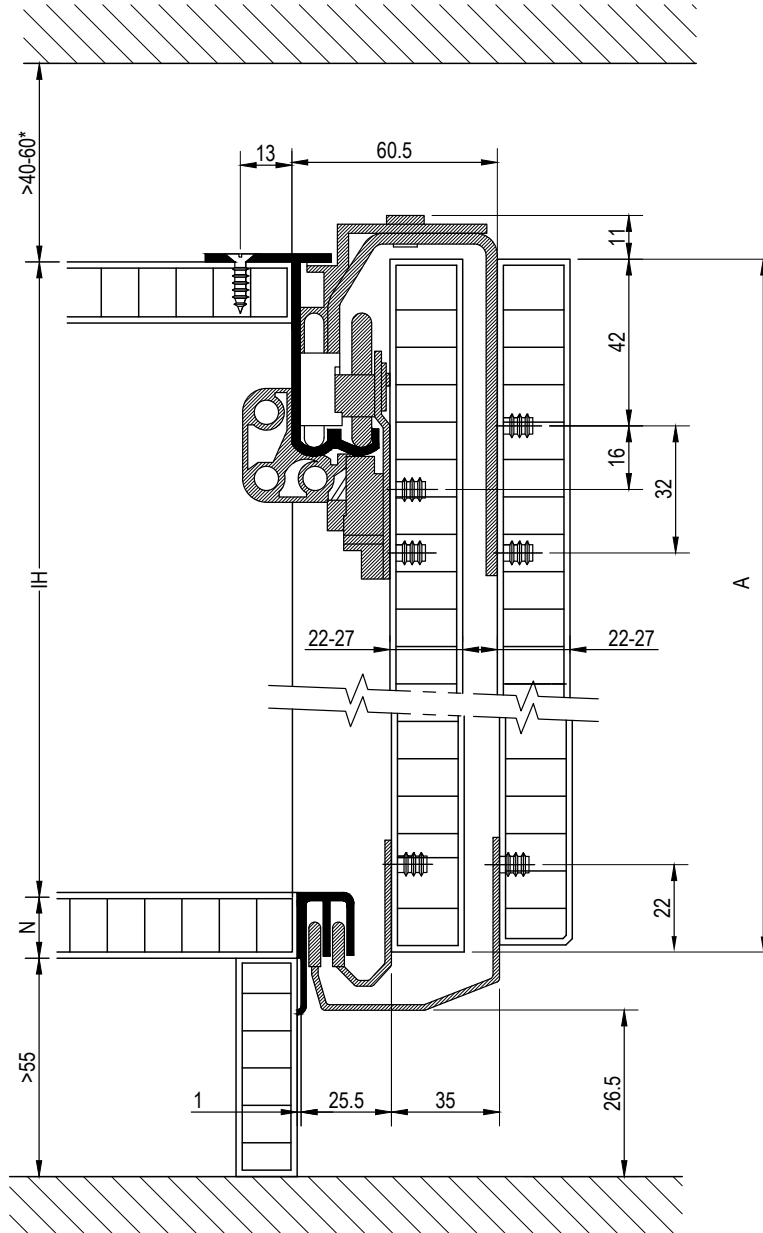

- A = Door height (Calculation: $A = IH + 35 \text{ mm}$)
- IH = Internal cabinet height + Top panel thickness
- N = Cabinet base panel thickness

Carcass Drawing:

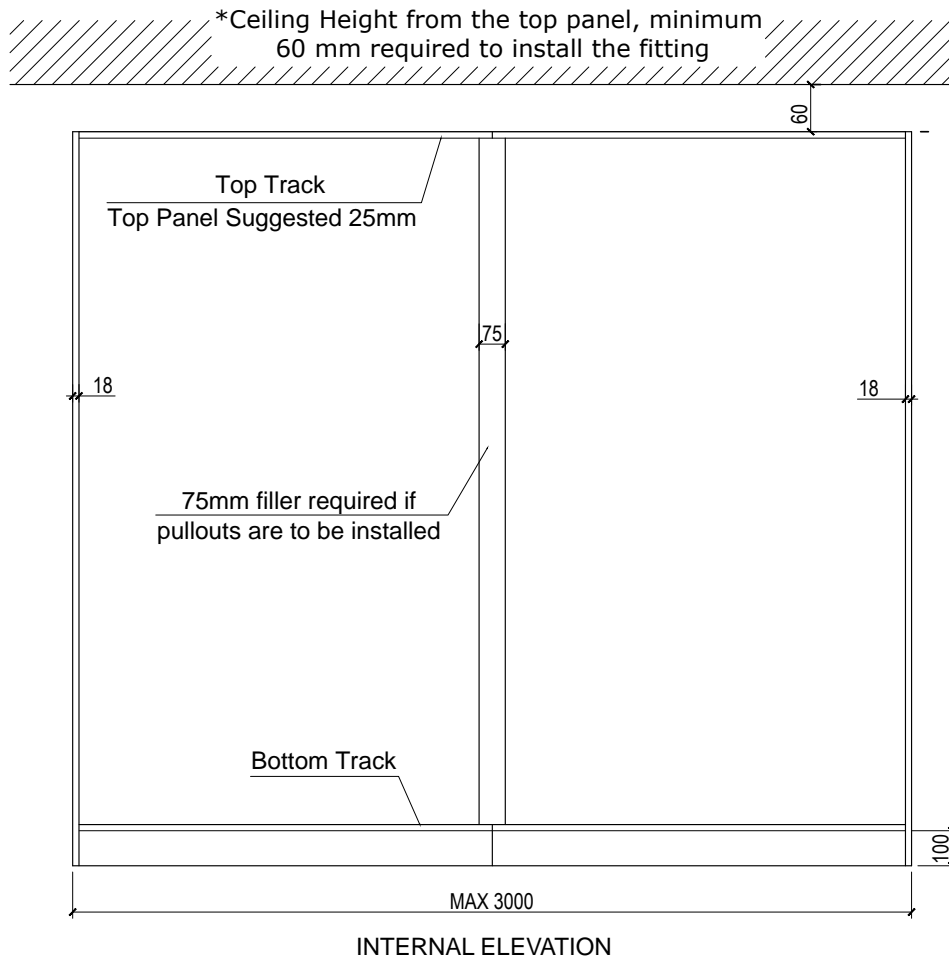
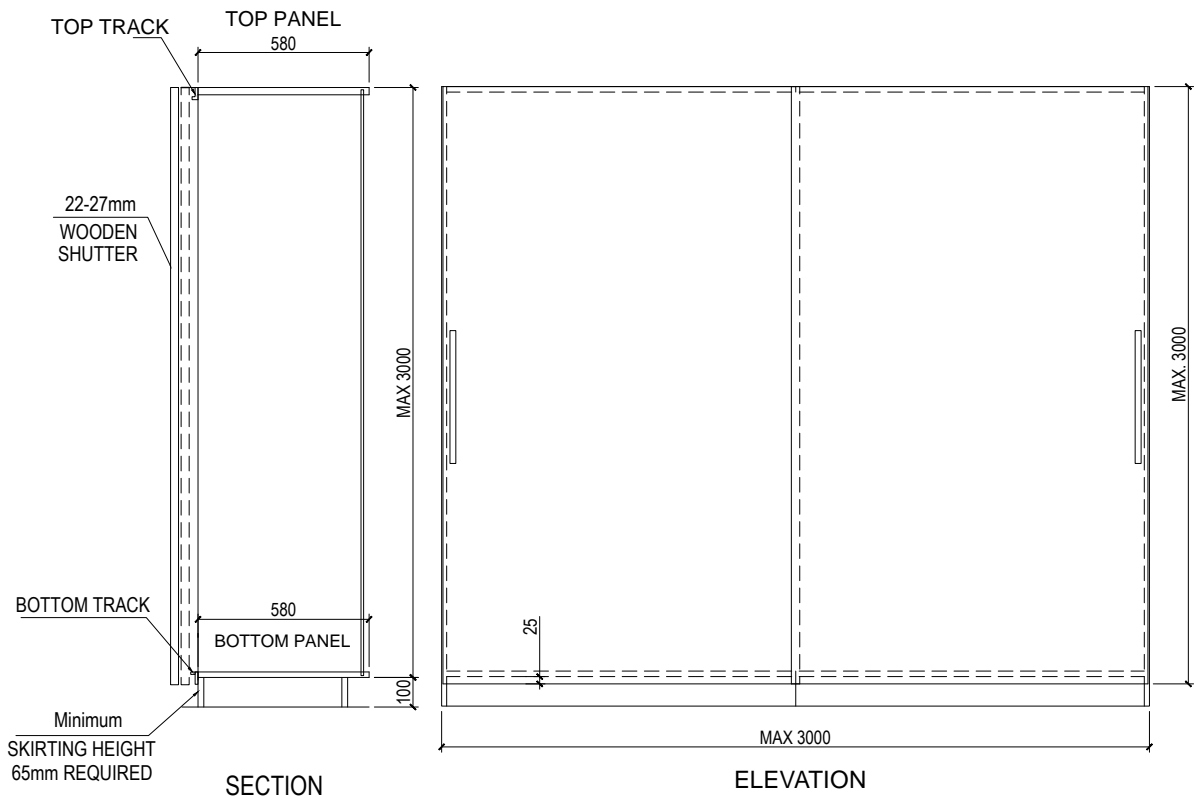

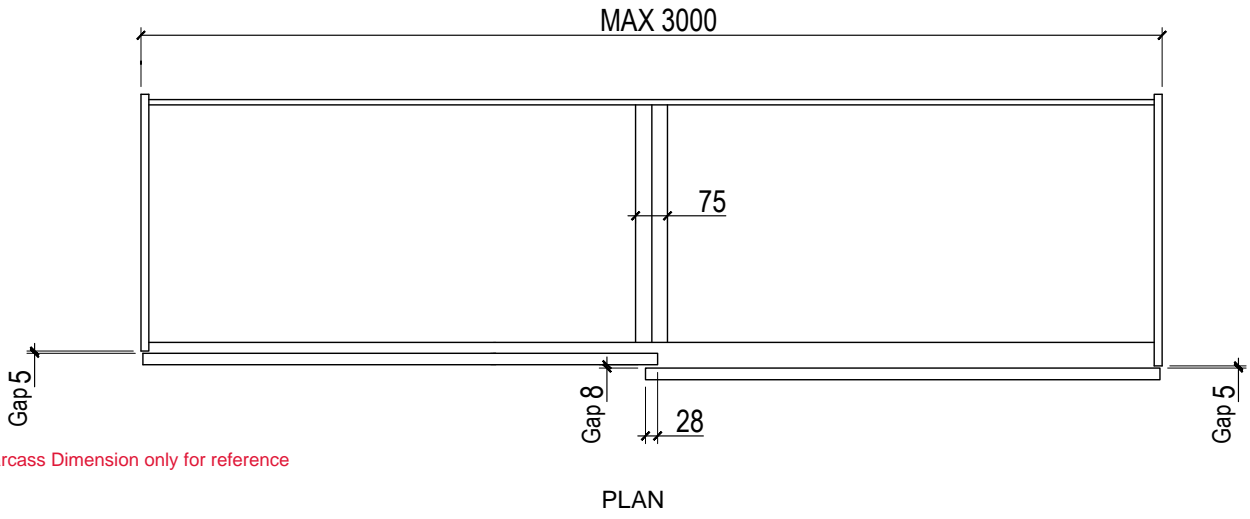



Classic 50 VF SR (ST-18)

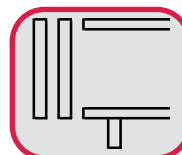
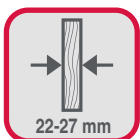
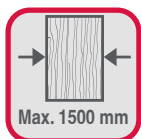

Vorfront sliding system for wooden wardrobe and furniture doors.

For Smuso, Please refer to Page No.:187
For E-Drive please refer to Page No.: 239

Hardware Specification:

- Smooth and effortless sliding doors
- Easy installation
- Suitable for 2 door and 3 door applications

Note: If you place the order using the individual components (as listed below), please order the track separately. Alternately if you place the order using the BOM Articles (mentioned in the BOM LIST table), the track is included.



Article No.: 400.51.121*

For 2 Doors - Sliding door kit consists of:

- 2 Running Gears with Ball Bearing
- 1 Running Gear for Inner Door
- 1 Running Gear with Pins
- 2 End Stoppers
- 2 Bottom Guides for Inner Door
- 2 Bottom Guides Adjustable
- 4 Clips for Guide
- 2 Support Blocks



Article No.: 400.51.123*

For 3 Doors - Sliding door kit consists of:

- 2 Running Gears with Ball Bearing
- 2 Running Gears for Inner Door
- 2 Running Gears with Pins
- 2 End Stoppers
- 4 Bottom Guides for Inner Door
- 2 Bottom Guides Adjustable
- 6 Clips for Guide
- 2 Support Blocks



Product Name	Article No.	L mm	
Silver anodized aluminium top track	400.52.026	2500 mm	
	400.52.036	3500 mm	
Silver anodized aluminium bottom track	400.52.952	2500 mm	
	400.52.953	3500 mm	

BOM LIST (Track Included)	
Description	Article No.
Classic 50 VF SR (ST-18) with 2.5 m track	401.29.011
Classic 50 VF SR (ST-18) with 3.5 m track	401.29.012

For 3 Doors: Order to be based on specifications and needs of the customer.
 *2 Door Alternate Article No.: 400.51.167 for 400.51.121 (Applicable soon)
 *3 Door Alternate Article No.: 400.51.168 for 400.51.123 (Applicable soon)

Section View:
Installation dimensions with roller runner

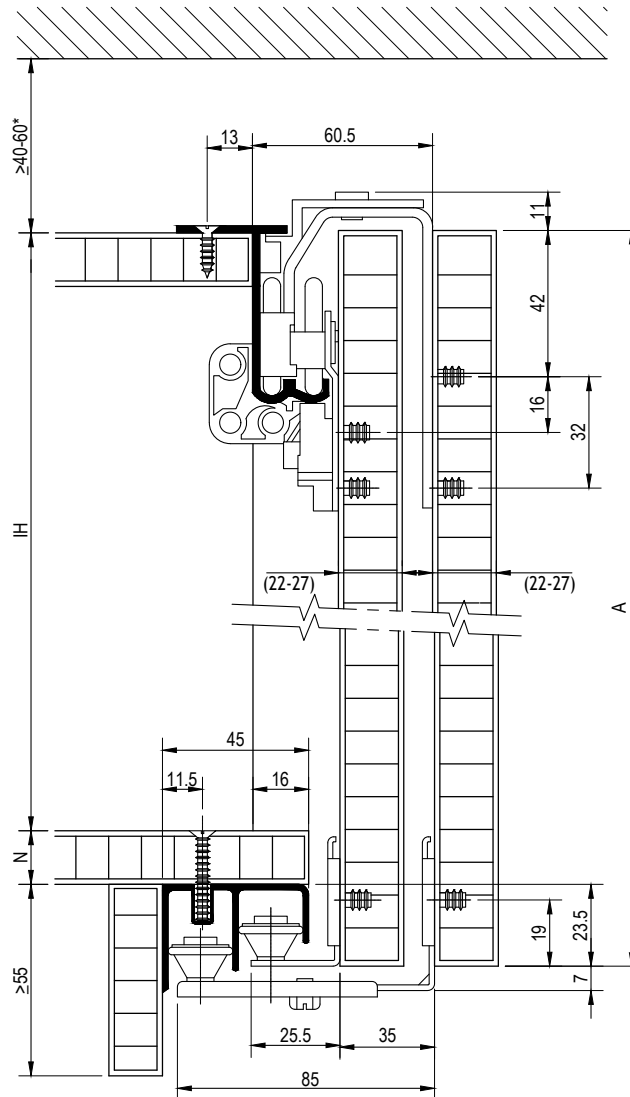

A = Door height (Calculation: $A = IH + N + 23.5$ mm)

IH = Internal cabinet height + Top panel thickness

N = Cabinet base panel thickness

Carcass Drawing

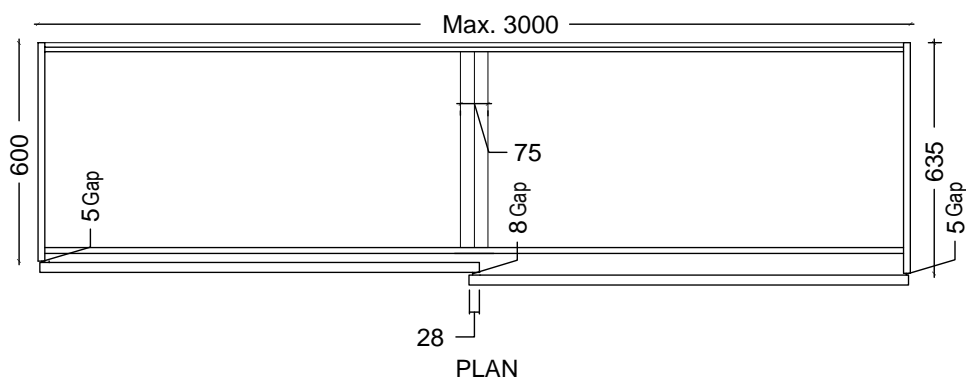

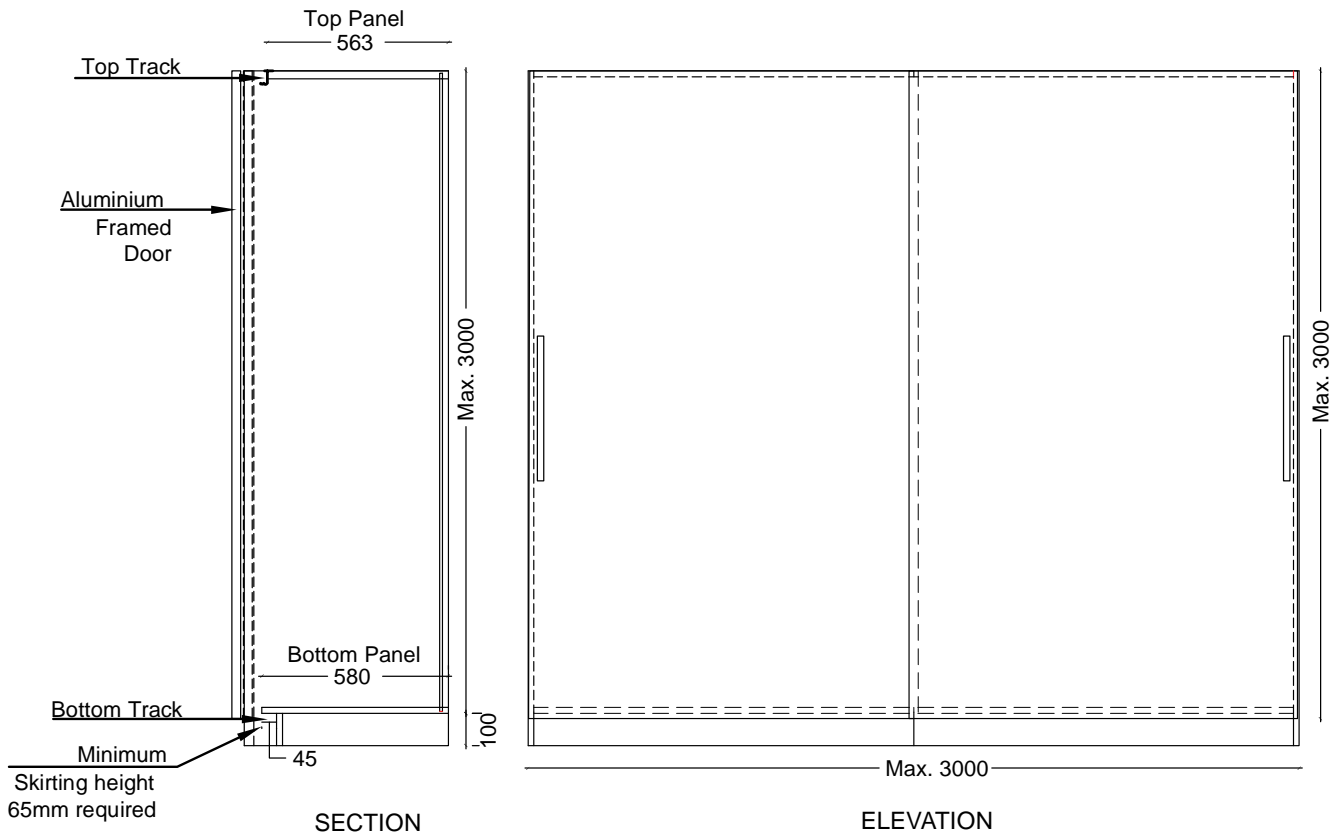

*Minimum gap of 60 mm is required between the top panel and the ceiling to install the fitting

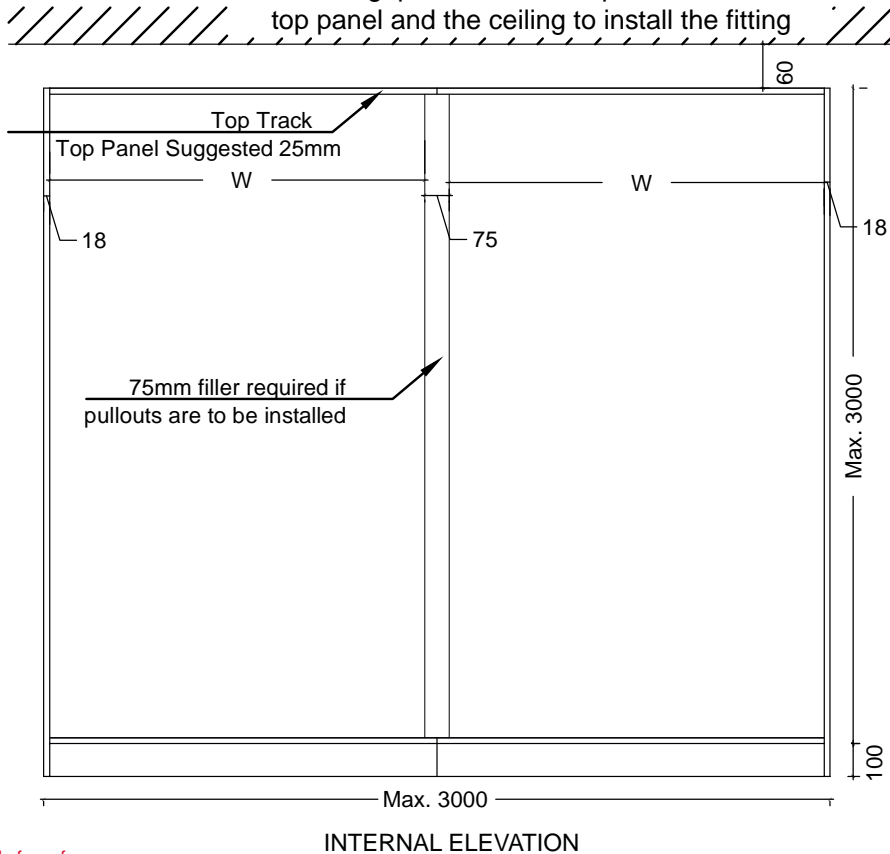

*Carcass Dimension only for reference

Smuso CD Soft Closing Mechanism

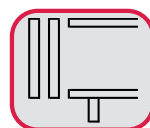



Smuso CD Soft Closing Mechanism applicable for
Classic 50 VF S (ST 18), Classic 50 VF SR (ST 18),
Classic IF 45 & Classic IF 50

Hardware Specification:

- Sliding door weights should not exceed 50 kg
- Material: Plastic
- Colour: Light grey
- Installation: For screw fixing beneath or to the cabinet top
- Mounting: For DIN left hand and DIN right hand use

Door up to 50 kg

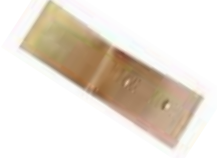
Product Name	Article No.	
Smuso soft close for door weights up to 50 kg	405.11.107	
Bracket for SMUSO soft close for inner door	405.11.161	
Bracket for SMUSO soft close for outer door	405.11.184	

*Smuso Alternate Article No.: 402.11.003 for 405.11.107 (Applicable soon)

Classic 60 VF

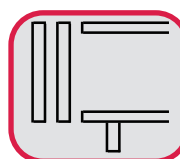
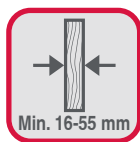
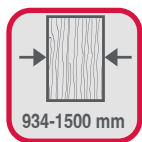
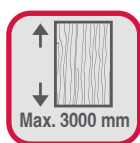
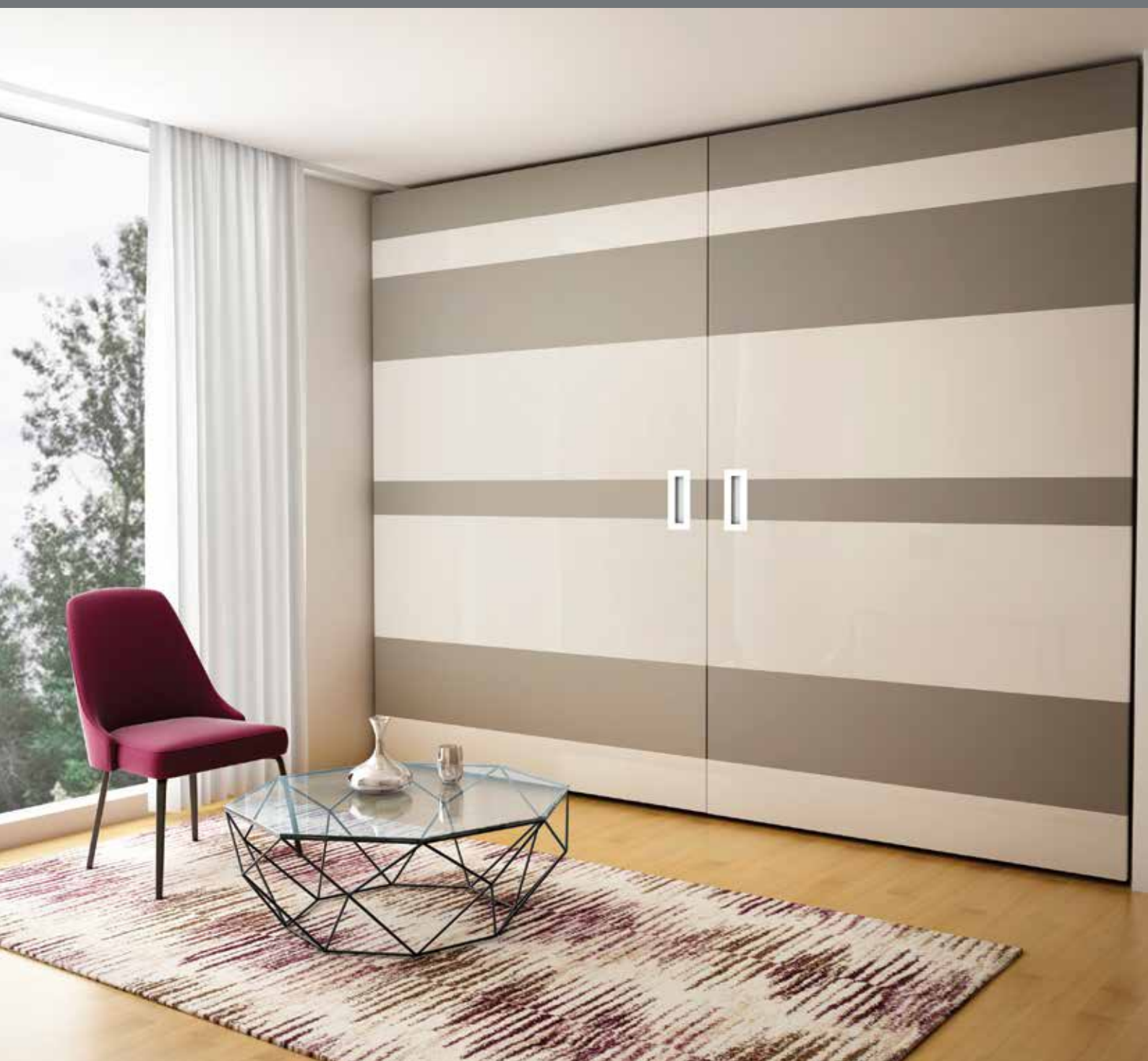

Flush (Vorfront) sliding system for wooden wardrobe and furniture doors.

For E-Drive please refer to Page No.: 239

Hardware Specification:

- 100% Flexibility:
 - No work of millings or drillings on upper and lower rails
 - No special construction of the cabinet
 - Standard stock management (one type profile and kit)

- Easy assembly:
 - The mechanism is inserted in the rail before fixing it on the cabinet
 - Vertical Adjustments: +6mm/ -4mm
 - Softspace: Soft closing & opening

Note: If you place the order using the individual components (as listed below), please order the track separately. Alternately if you place the order using the BOM Articles (mentioned in the BOM LIST table), the track is included.



For Left Door- Article No.: 400.50.008

- 1 Pair slide kit for left door consists of:
- 1 Steel Upper Slide
 - 1 Steel Lower Slide
 - 2 Zamac Hooking Device
 - 2 Fixing For Lower Slide
 - 1 Plastic Upper Lock
 - 1 Zamac Lower Lock
 - 1 Door Corner Spacers Kit

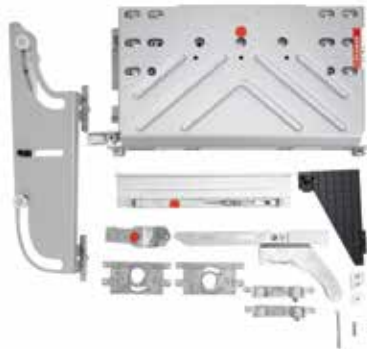

For Right Door - Article No.: 400.50.001

- 1 Pair slide kit for right door consists of:
- 1 Steel Upper Slide
 - 1 Steel Lower Slide
 - 2 Zamac Hooking Device
 - 2 Fixing For Lower Slide
 - 1 Plastic Upper Lock
 - 1 Zamac Lower Lock
 - 1 Door Corner Spacers Kit

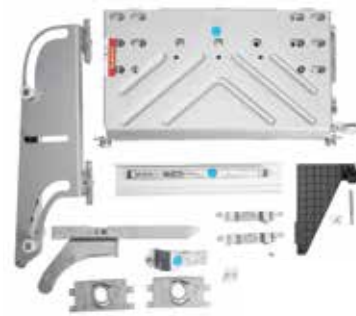

SOFTSPACE device kit with activator
(Note: Available in the kit)

Product Name	Article No.	L mm	
Silver anodized aluminium top track	409.50.600	3050 mm	
Silver anodized aluminium bottom track	409.50.800	3050 mm	

BOM LIST (Track Included)	
Description	Article No.
Classic 60 VF for 2 doors with 3 mtr track and kit straightener	400.50.017

Section View:

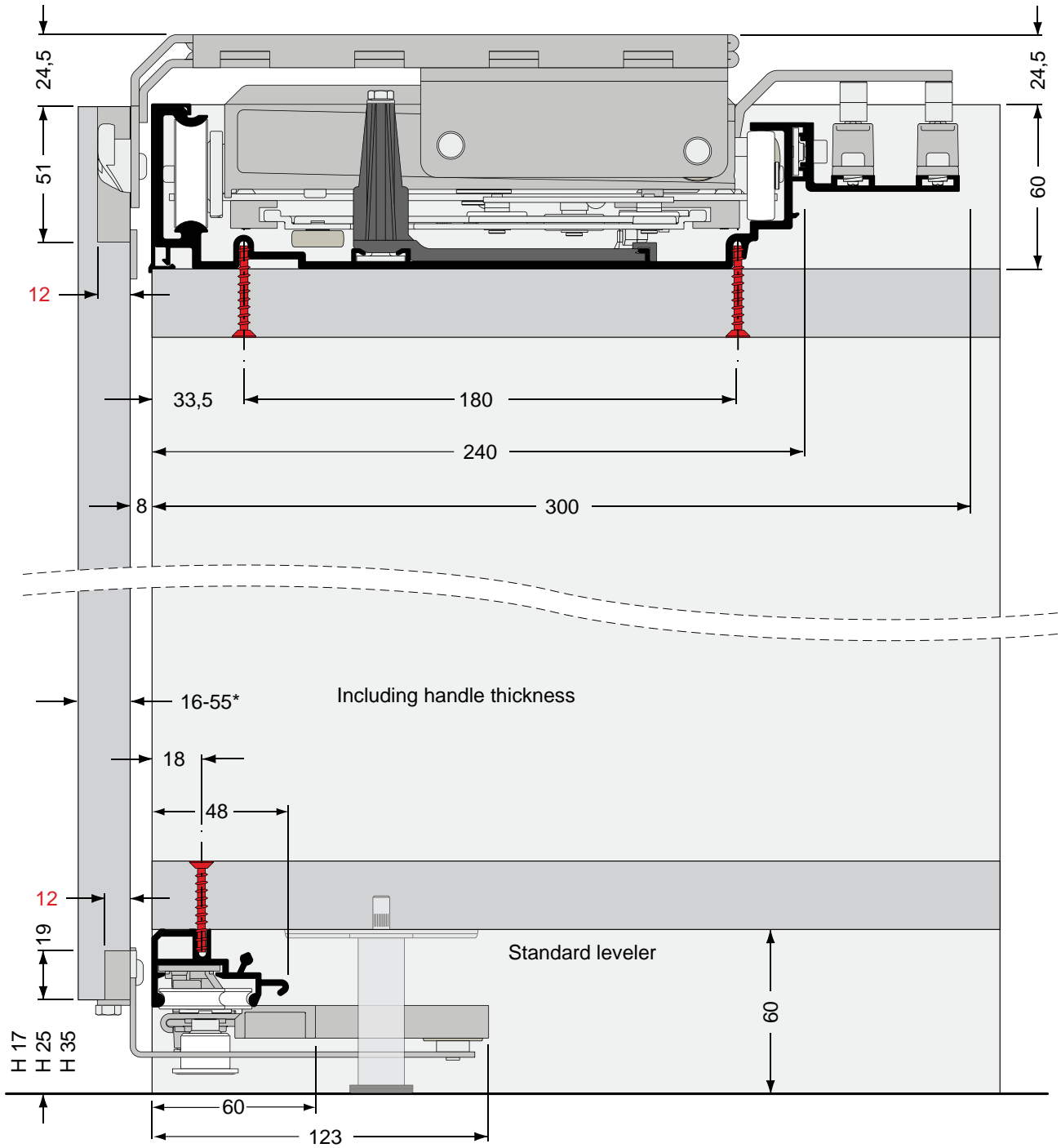

Door Cut Out:

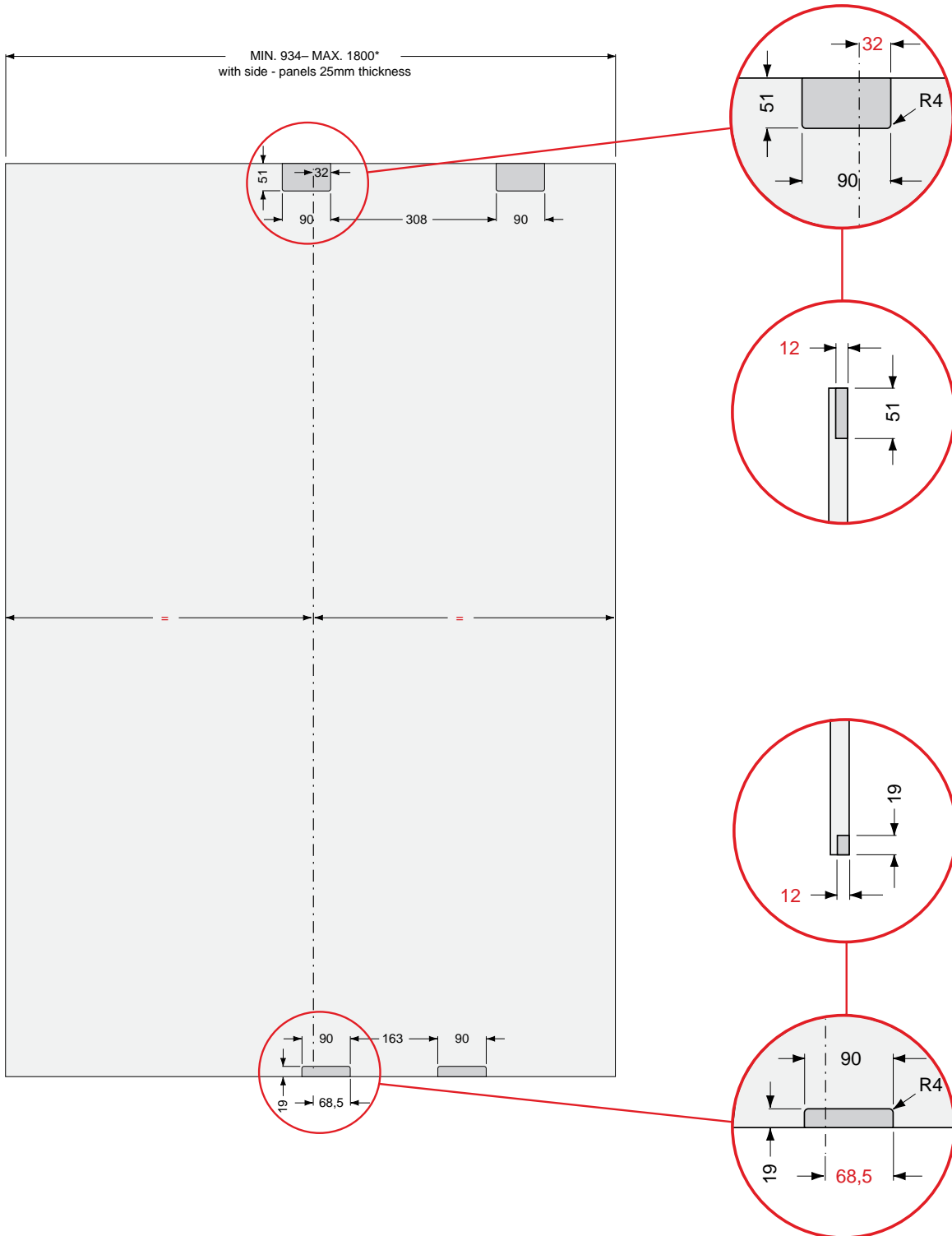

Standard Application:

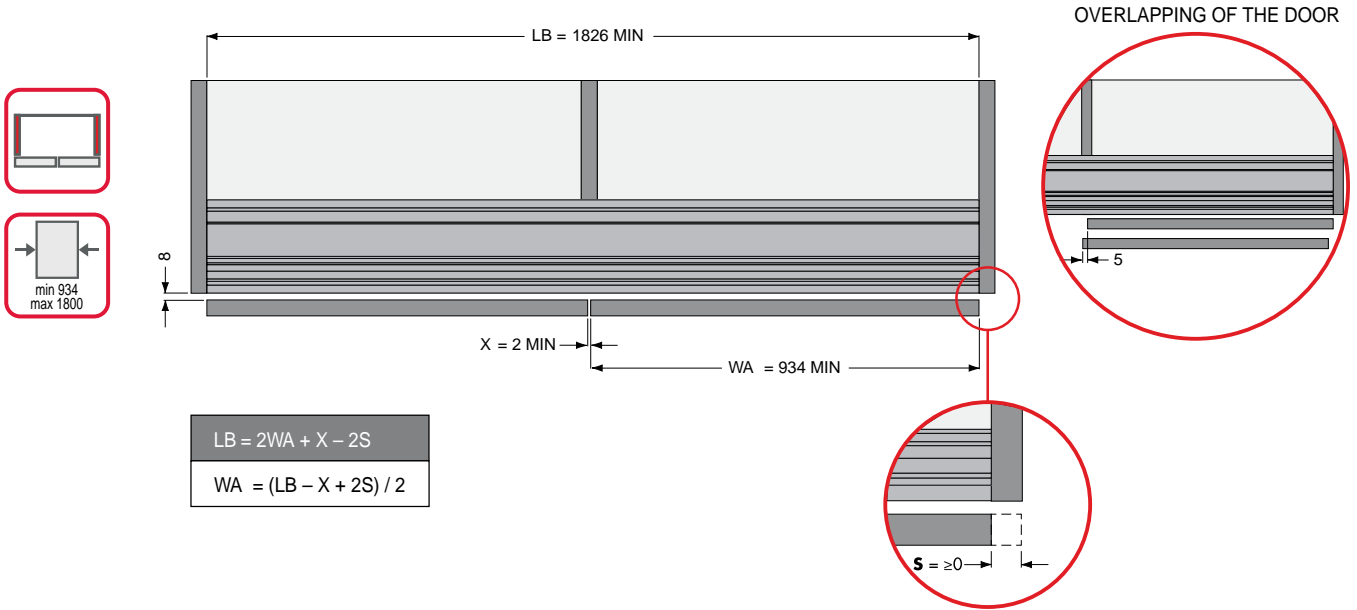

Inset Application:

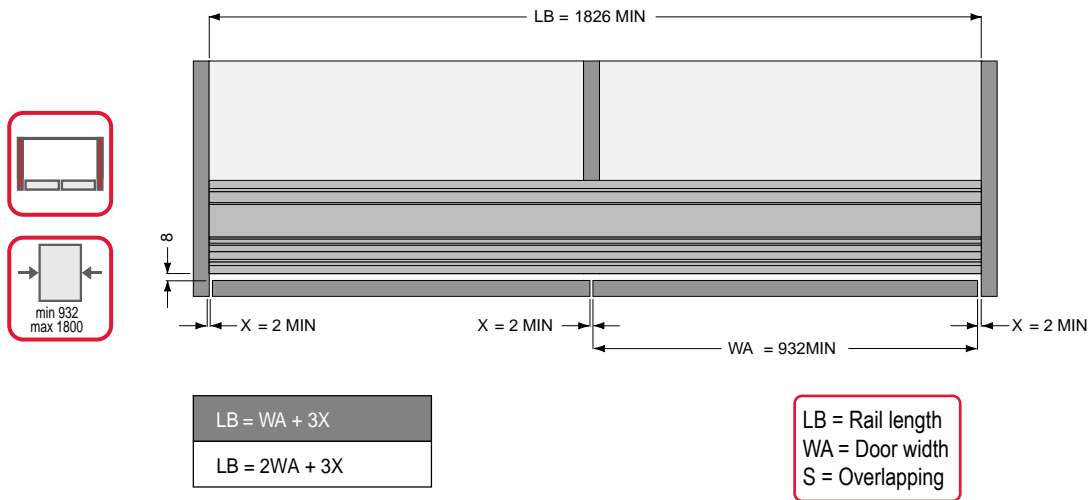

Carcass Drawing:

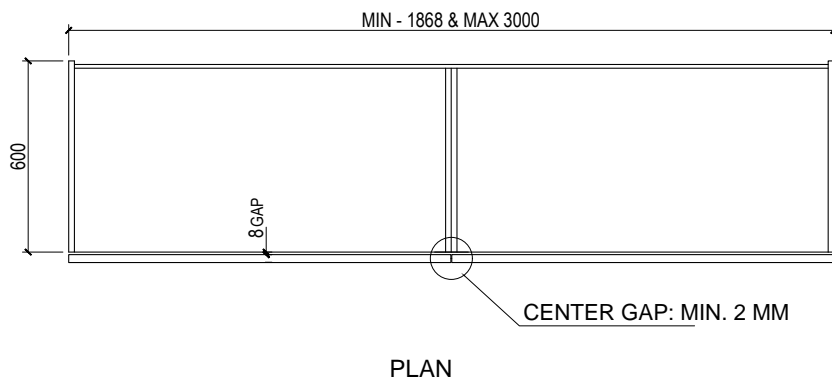

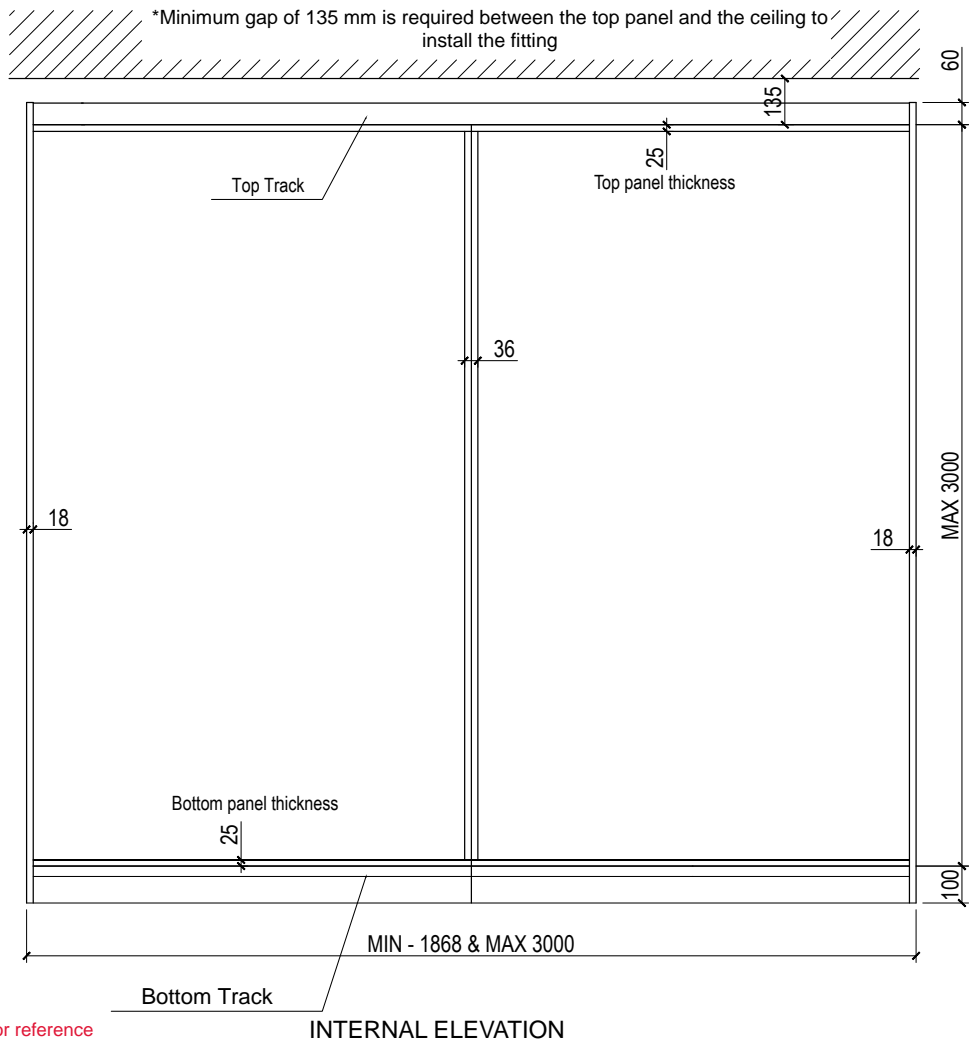
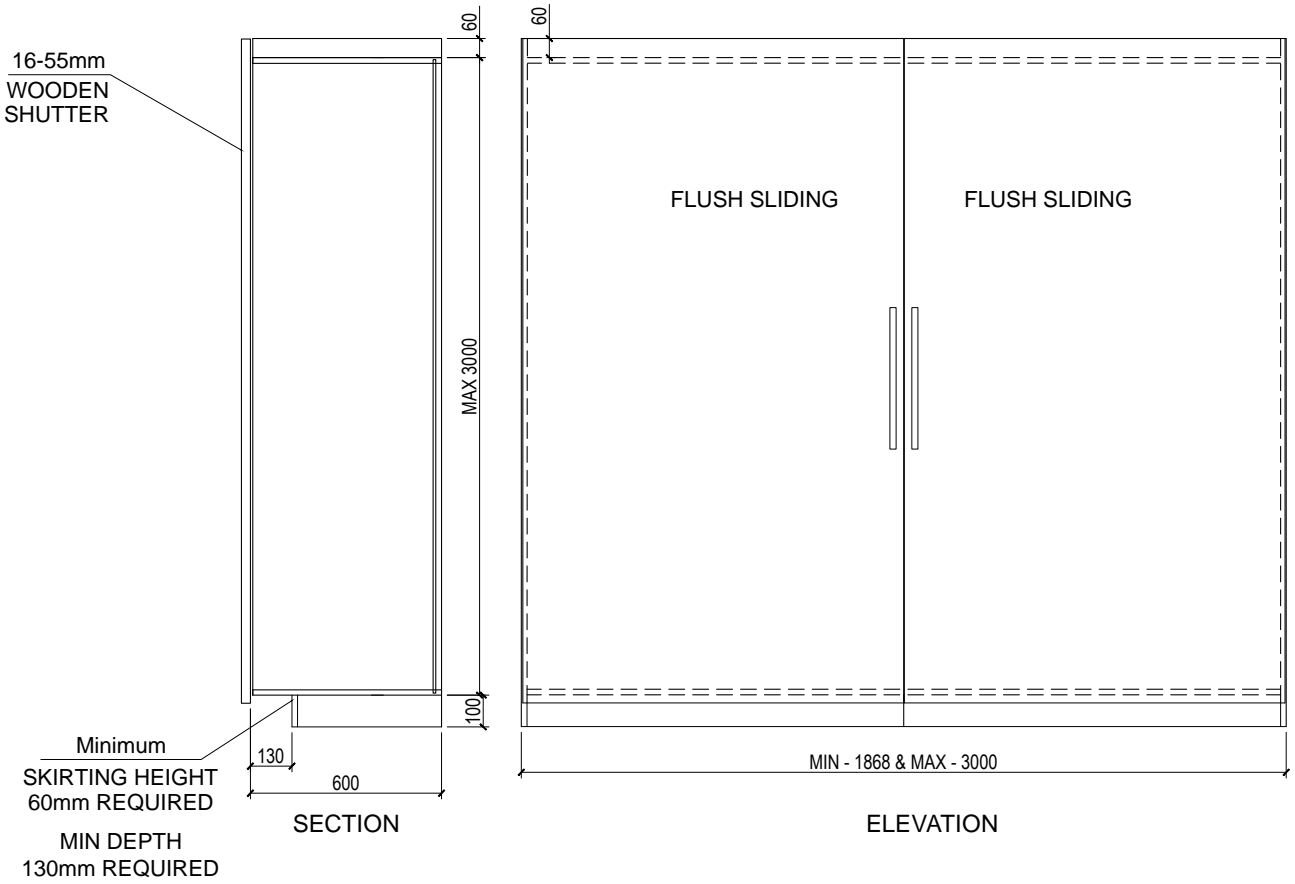

*Carcass Dimension only for reference



Classic Duo 80 VF

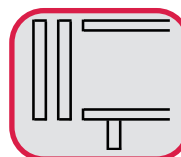
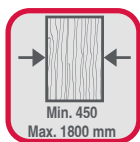
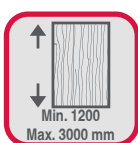
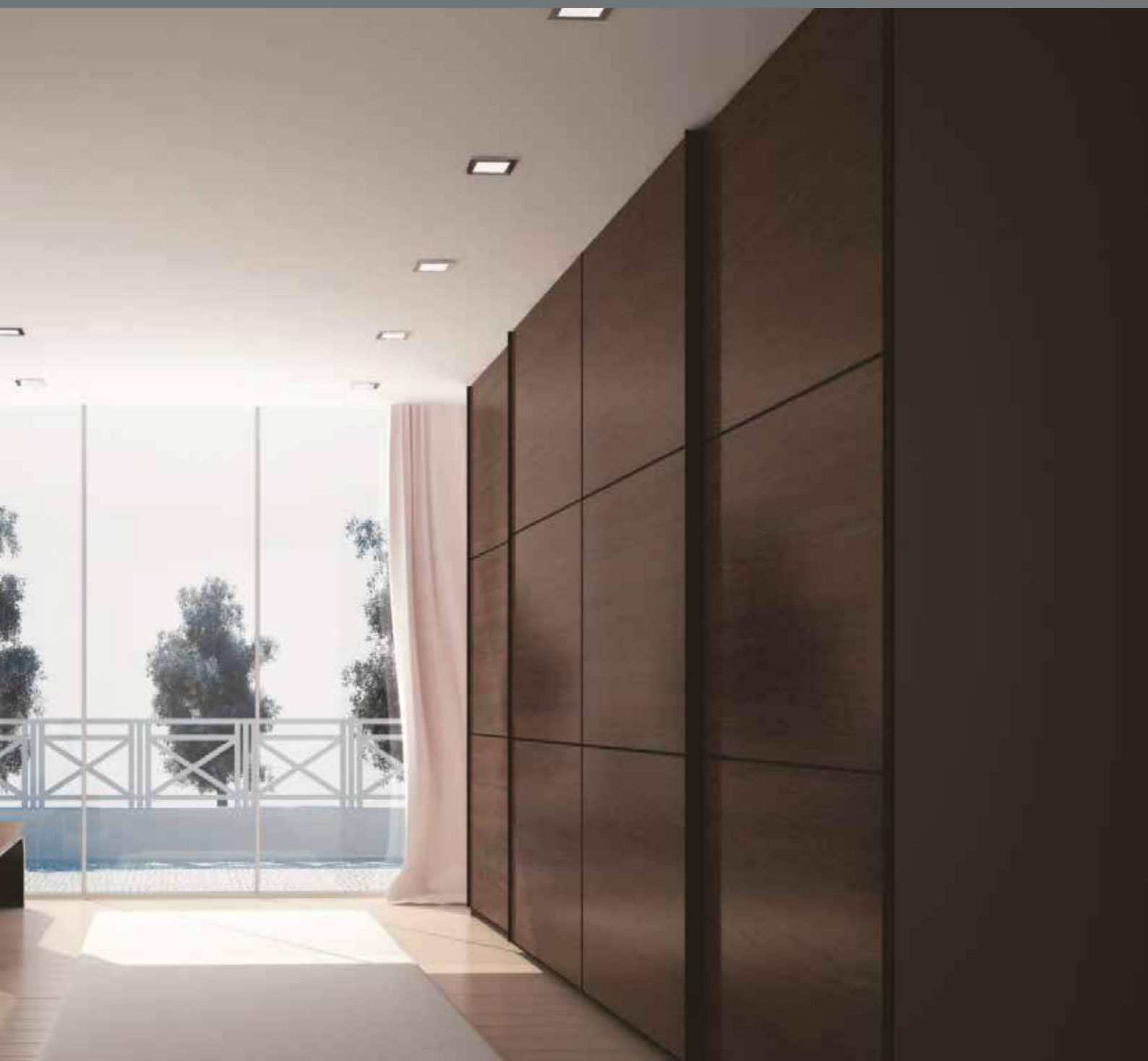

Vorfront sliding system for wooden wardrobe and furniture doors.

For E-Drive please refer to Page No.: 239

Hardware Specification :

- High load capacity up to 80 kg
- More than one adjustment
- Door thickness 28mm & 38mm
- Anti derailing system inside the lower slide
- Provides easy way to mount heavy doors onto the furniture with just a clack
- Adjustment: +3mm/-3mm (vertical adjustment)
- Soft Closing: opening and closing



Kit for **Wooden Door**.

Article No.: 409.36.112

For Door Thickness of 28 mm

External door kit consists of:

- 2 Steel Adjustable Upper Slide
- 2 Steel Lower Slide with Wheel and O-Ring
- 1 Right Plastic Adjustable Upper Lock
- 1 Left Plastic Adjustable Upper Lock
- 1 Plastic Upper Central Lock.
- 2 Plastic Lower Lock
- 1 Rounded Socket Key with 4 mm Hexagonal Ends



Article No.: 409.36.110

For Door Thickness of 38 mm

External door kit consists of:

- 2 Steel Adjustable Upper Slide
- 2 Steel Lower Slide with Wheel and O-Ring
- 1 Right Plastic Adjustable Upper Lock
- 1 Left Plastic Adjustable Upper Lock
- 1 Plastic Upper Central Lock.
- 2 Plastic Lower Lock
- 1 Rounded Socket Key with 4 mm Hexagonal Ends



Article No.: 409.36.111

Internal door kit consists of:

- 2 Steel Adjustable Upper Slide
- 2 Steel Lower Slide with Wheel and O-Ring
- 1 Right Plastic Adjustable Upper Lock
- 1 Left Plastic Adjustable Upper Lock
- 1 Plastic Upper Central Lock.
- 2 Plastic Lower Lock
- 1 Rounded Socket Key with 4 mm Hexagonal Ends



SOFTSPACE Device For External & Internal Door
(Note: Available in the kit)



Only for 3 Door Application

Article No.: 409.36.050

For Door Thickness of 28 mm

External Central Double Side Soft Close door kit consists of:

- 2 Steel Adjustable Upper Slide
- 2 Steel Lower Slide with Wheel and O-Ring
- 1 Right Plastic Adjustable Upper Lock
- 1 Left Plastic Adjustable Upper Lock
- 1 Plastic Upper Central Lock.
- 2 Plastic Lower Lock
- 1 Rounded Socket Key with 4 mm Hexagonal Ends
- 1 Central Double Side Soft Close
- 1 Soft Close



Article No.: 409.36.051

For Door Thickness of 38 mm

External Central Double Side Soft Close door kit consists of:

- 2 Steel Adjustable Upper Slide
- 2 Steel Lower Slide with Wheel and O-Ring
- 1 Right Plastic Adjustable Upper Lock
- 1 Left Plastic Adjustable Upper Lock
- 1 Plastic Upper Central Lock.
- 2 Plastic Lower Lock
- 1 Rounded Socket Key with 4 mm Hexagonal Ends
- 1 Central Double Side Soft Close
- 1 Soft Close



Accessories

Article No.: 400.50.504

External Door Save- Dust Plastic Profile

Length : 3000 mm

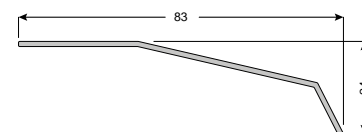
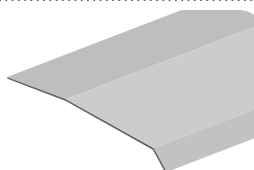

Article No.: 400.50.505

White Tape Bi- adhesive

Length : 40 X 10 X 1.5 for Save Dust Plastic Profile

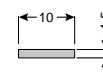
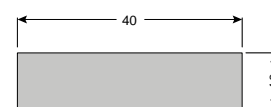
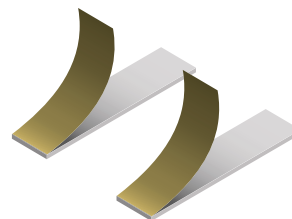

Product Name	Article No.	L mm 	
Silver anodized aluminium top track (Note: Track to be ordered separately)	409.36.606	3000 mm	
	409.36.604	3600 mm	
Silver anodized aluminium bottom track (Note: Track to be ordered separately)	400.50.936	3000 mm	
	400.50.804	3600 mm	
Kit straightener (optional)	400.50.011		

BOM LIST	
Description	Article No.
Classic Duo 80 VF for 2 Doors of Thickness 28 mm with 3 m Track and Kit Straightener	409.36.002
Classic Duo 80 VF for 3 Doors of Thickness 28 mm with 3 m Track and Kit Straightener	409.36.003
Classic Duo 80 VF for 2 Doors of Thickness 38 mm with 3 m Track and Kit Straightener	409.36.004
Classic Duo 80 VF for 3 Doors of Thickness 38 mm with 3 m Track and Kit Straightener	409.36.005
Classic Duo 80 VF for 2 Doors of Thickness 28 mm with 3 m Track	409.36.006
Classic Duo 80 VF for 3 Doors of Thickness 28 mm with 3 m Track	409.36.007
Classic Duo 80 VF for 2 Doors of Thickness 38 mm with 3 m Track	409.36.008
Classic Duo 80 VF for 3 Doors of Thickness 38 mm with 3 m Track	409.36.009

Note: The Central door in case of 3 door application can be moved on either side (i.e. left or right) with feature of soft opening and closing for all 3 doors.

Section View:

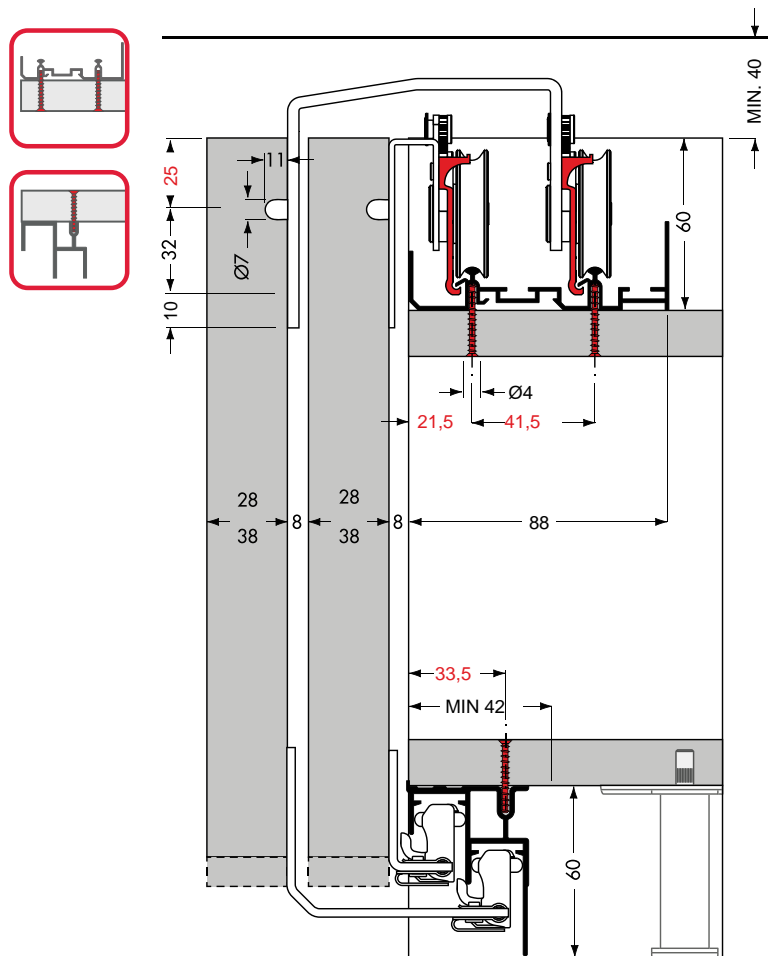

Drilling Pattern:

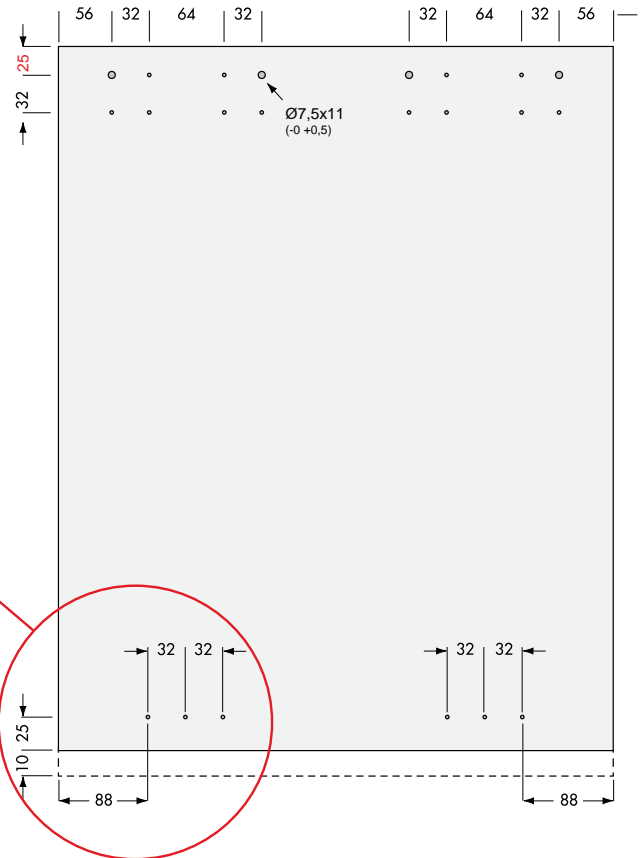
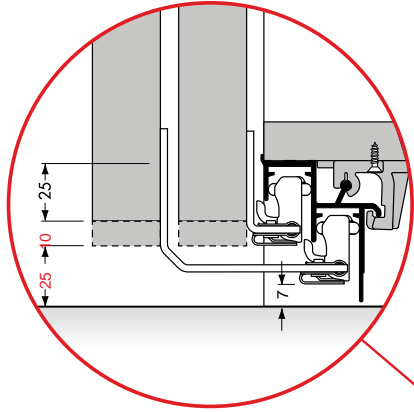
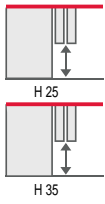

Plan:
External Central Double Side Soft Close

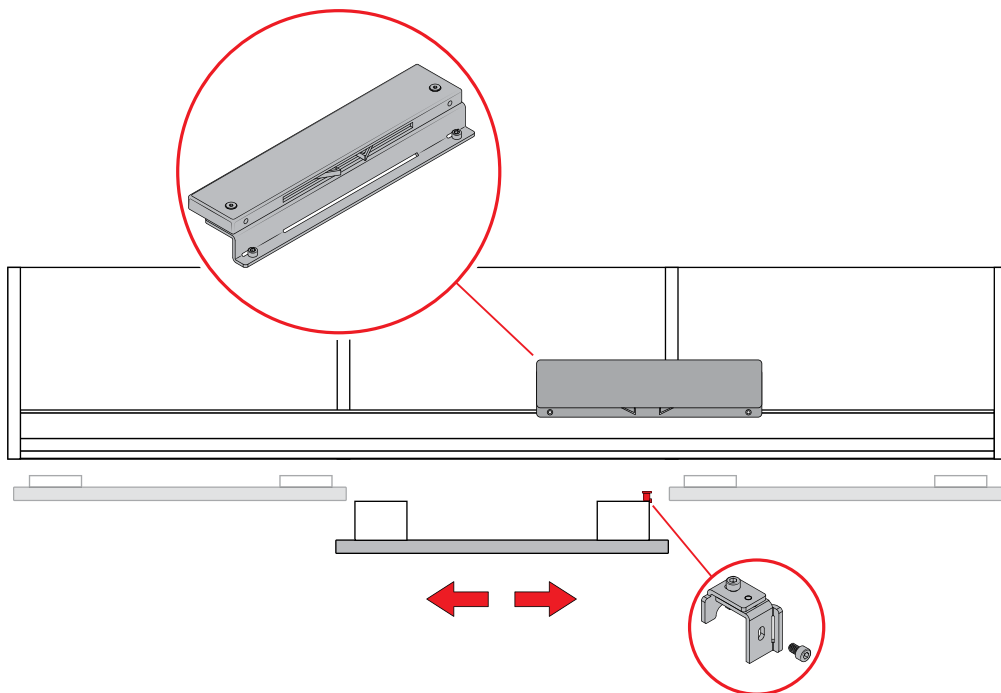

Carcass Drawing:

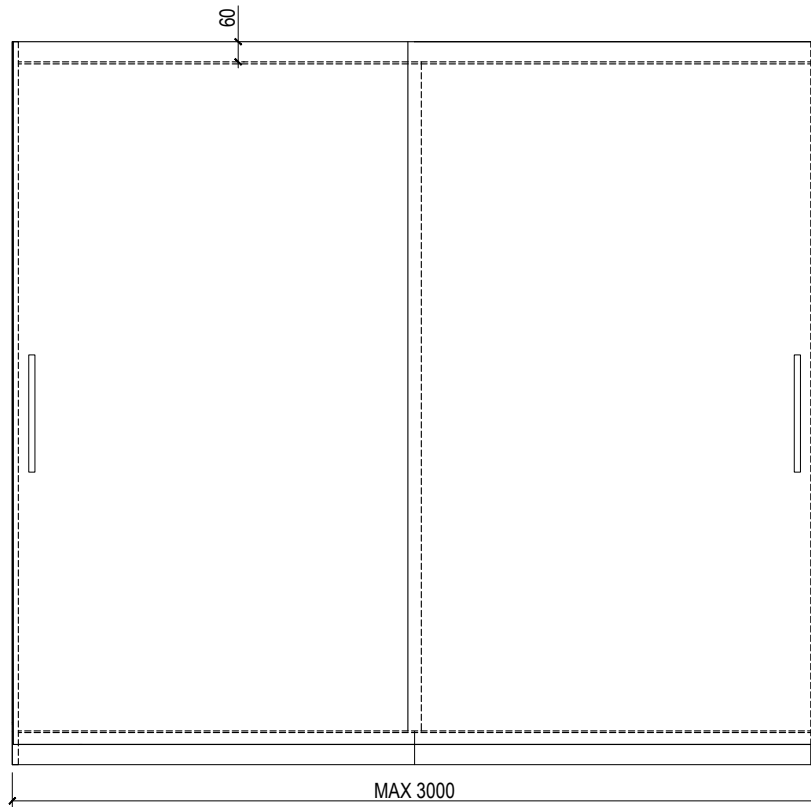

ELEVATION

*Minimum gap of 135 mm is required between the top panel and the ceiling to install the fitting

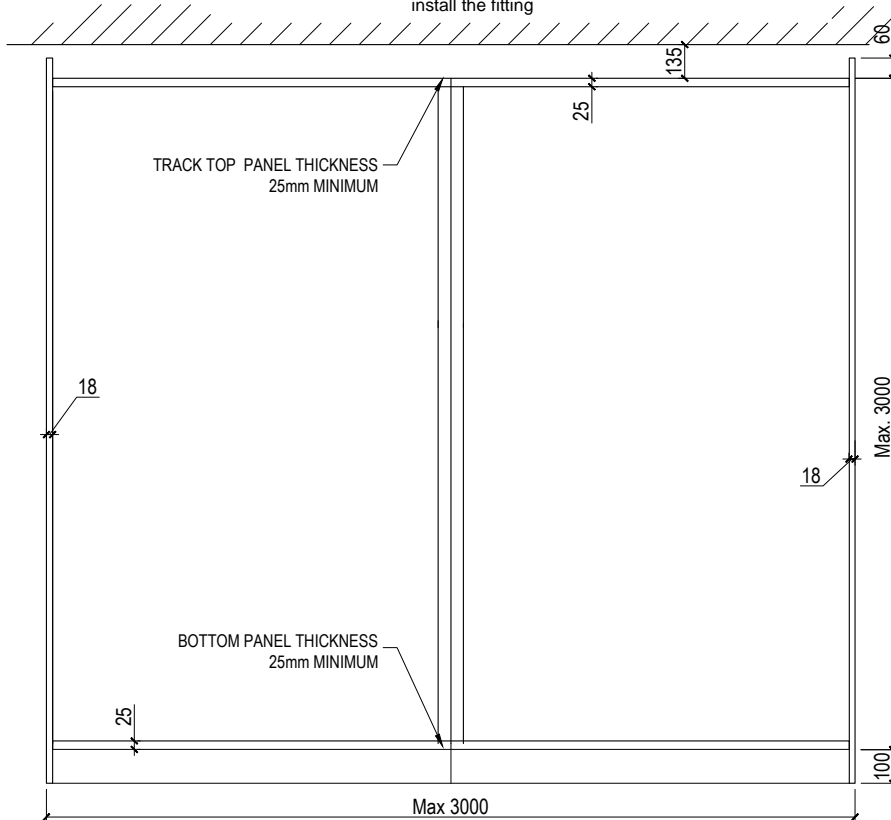

INTERNAL ELEVATION

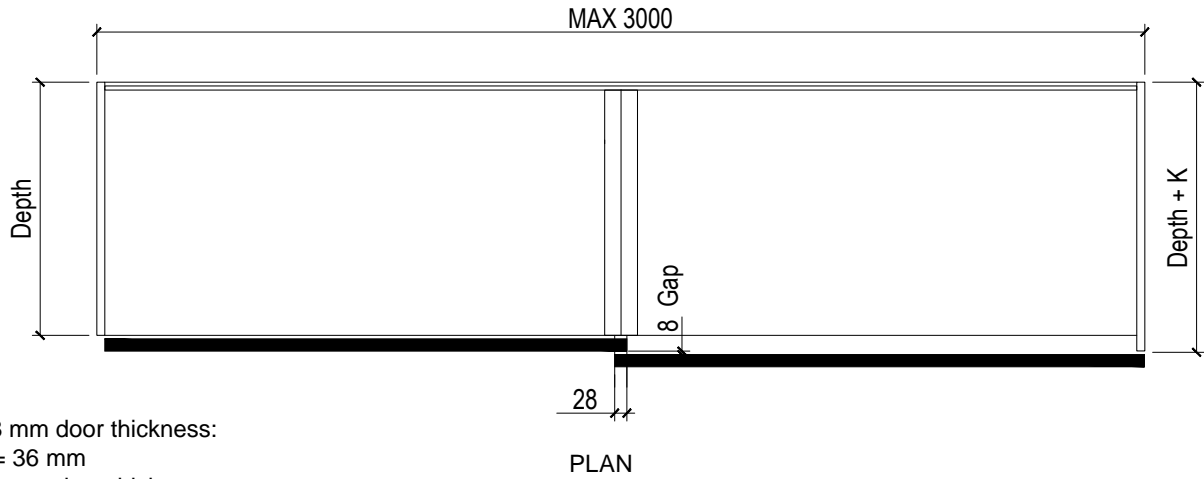

28 mm door thickness:
K= 36 mm
38 mm door thickness:
K=46 mm

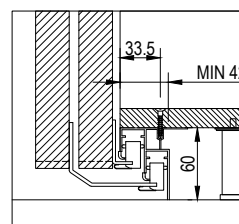
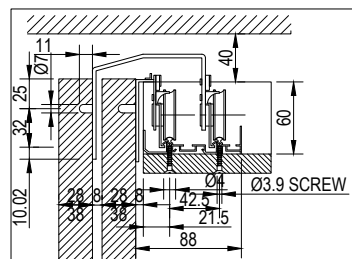
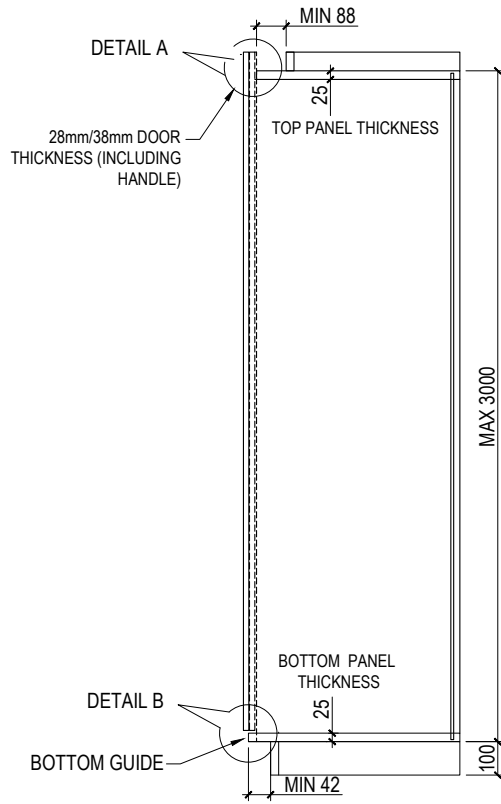

*Carcass Dimension only for reference

Fold 40 MF

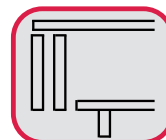
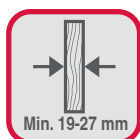
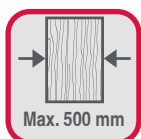
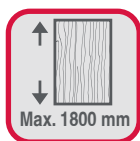

Mixfront wardrobe sliding folding system for wooden doors (Floating Panel).

Hardware Specification:

- Door stacks can consist of any number of individually coupled and free moving doors
- Smooth and efficient stacking of coupled door pairs
- Bottom guide is not required for doors attached at the side



Note: If you place the order using the individual components (as listed below), please order the track separately. Alternately if you place the order using the BOM Articles (mentioned in the BOM LIST table), the track is included.



Article No.: 410.25.000

Sliding door kit 1 pair consists of:

- 1 Running Gear Left
- 1 Running Gear Right
- 1 Top Guide
- 1 Bottom Guide (Left)
- 1 Bottom Guide (Right)
- 1 Bottom Guide
- 3 Panel to Panel Hinges
- 2 Door Deflectors
- 1 End Stop, Top Left
- 1 End Stop, Top Right
- 2 Door Stoppers, Bottom



Product Name	Article No.	L mm	
Silver anodized aluminium top track	410.25.622	2500 mm	
	410.25.623	3500 mm	
	410.25.625	5000 mm	
Silver anodized aluminium bottom track	410.25.812	2500 mm	
	410.25.813	3500 mm	
	410.25.815	5000 mm	

BOM LIST (Track Included)	
Description	Article No.
Fold 40 MF with 2500 mm track	401.29.025
Fold 40 MF with 3500 mm track	401.29.026
Fold 40 MF with 5000 mm track	401.29.027

Section View:

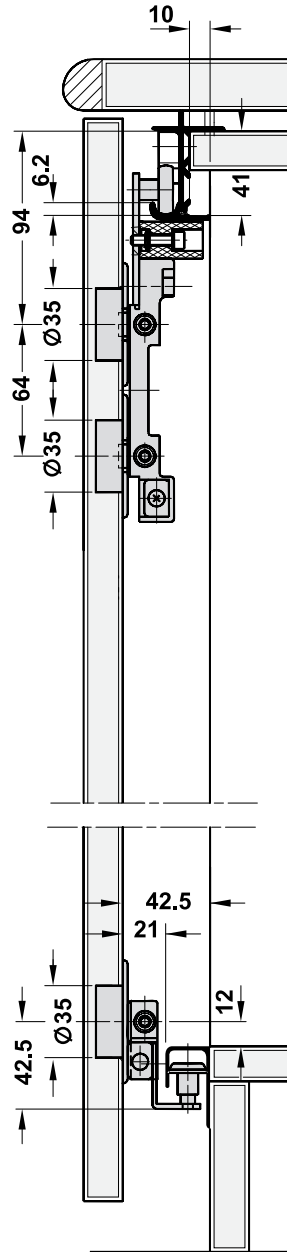

Calculation of door width

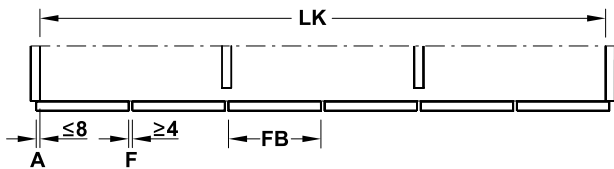

$$FB = \frac{LK + (2 \times A) - (\text{number of gaps} \times F \text{ mm})}{\text{Number of doors}}$$

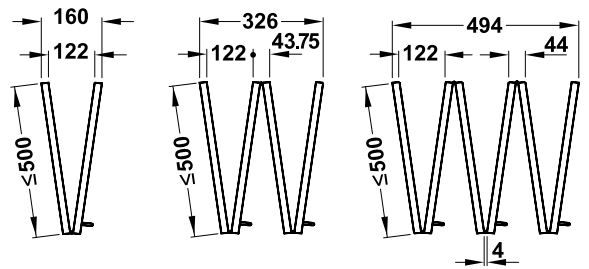

- LK = internal cabinet width
- FB = door width
- A = door overlay
- F = gap

Drilling Pattern for Door:

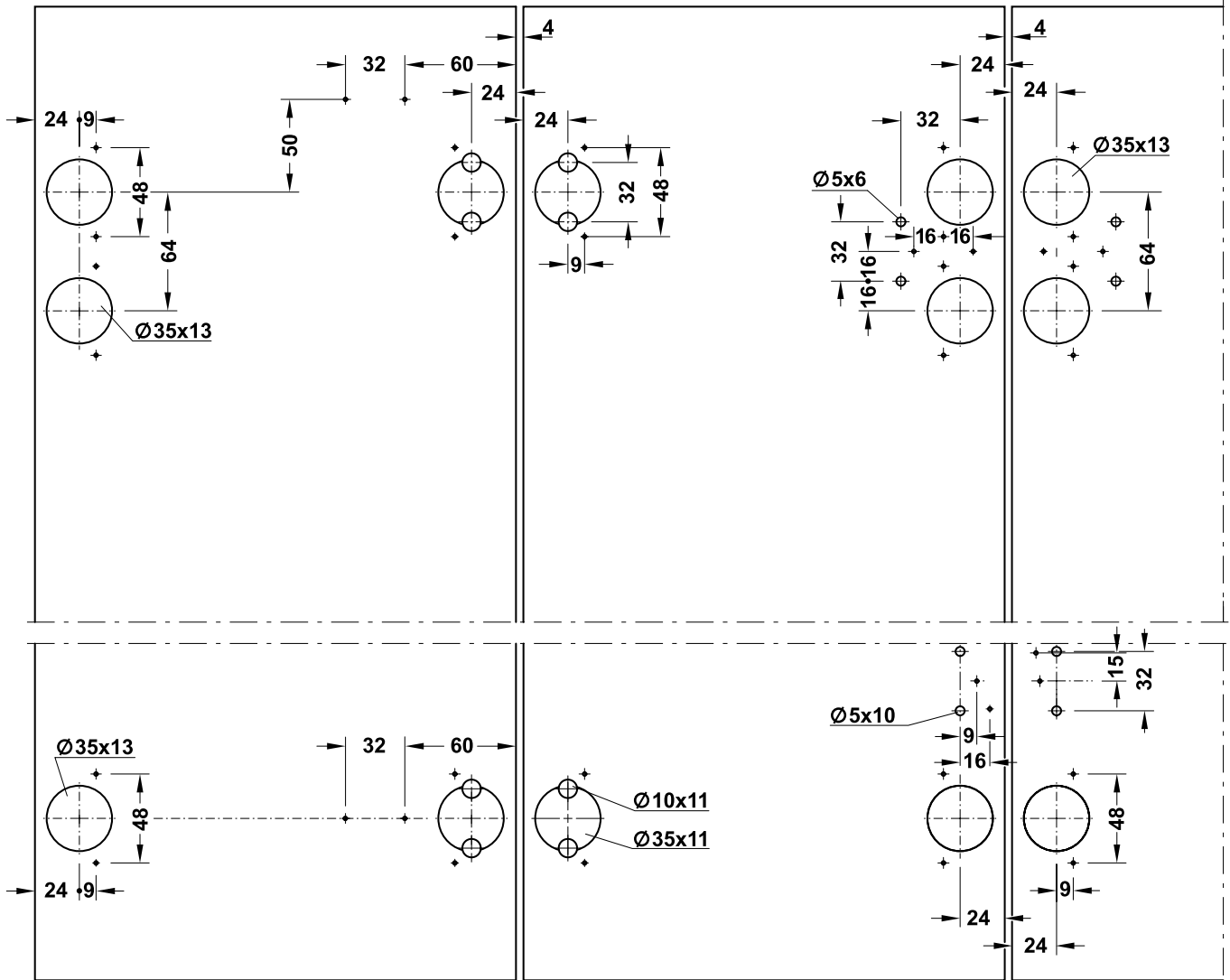

Slide Fold 25/50



Slide Fold 50

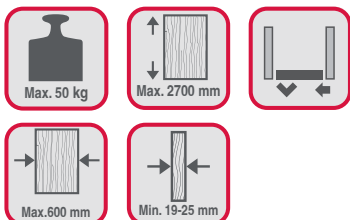

Slide Fold 25

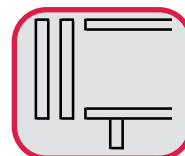
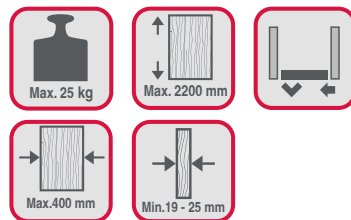

Vorfront wardrobe end-fixing sliding systems for wooden doors.

Slide Fold 50

Hardware Specification:

- 50 kgs for 2 panels
- Door thickness from 19mm - 25mm
- Number of doors: 2 or 4
- End fixing sliding folding system without a bottom track
- Soft closing

Slide Fold 25

Hardware Specification:

- 25 kgs for 2 panels
- Door thickness from 19mm - 25mm
- Number of doors: 2 or 4
- End fixing sliding folding system without a bottom track
- Soft closing



KIT FOR SLIDE FOLD 50

Article No.: 409.36.100

Left side opening



- 1 Kit of steel upper slide with
- 2 hinge
- 1 screw



KIT FOR SLIDE FOLD 50

Article No.: 409.36.101

Right side opening

- 1 Kit of steel upper slide with
- 2 hinge
- 1 screw



KIT FOR SLIDE FOLD 25

Article No.: 409.36.102

Left side opening

- 1 Kit of steel upper slide with
- 1 hinge
- 1 screw



KIT FOR SLIDE FOLD 25





Article No.: 409.36.103

Right side opening

- 1 Kit of steel upper slide with
- 1 hinge
- 1 screw



SLIDE FOLD 25/50

Product Name	Article No.		
Plastic cover (Optional)	409.36.410	-	
Steel hinge	409.36.411	-	
Upper track (Note: Track to be ordered separately)	409.36.610	3000 mm	

Note:

- 1) Hinges for the sides need to be ordered separately as per the door thickness and material.
- 2) In order to achieve a soft closing effect, use the Hafele Metalla Hinges with in-built soft close or Blum Hinges with built-in BLUMOTION

Section View:
Wood

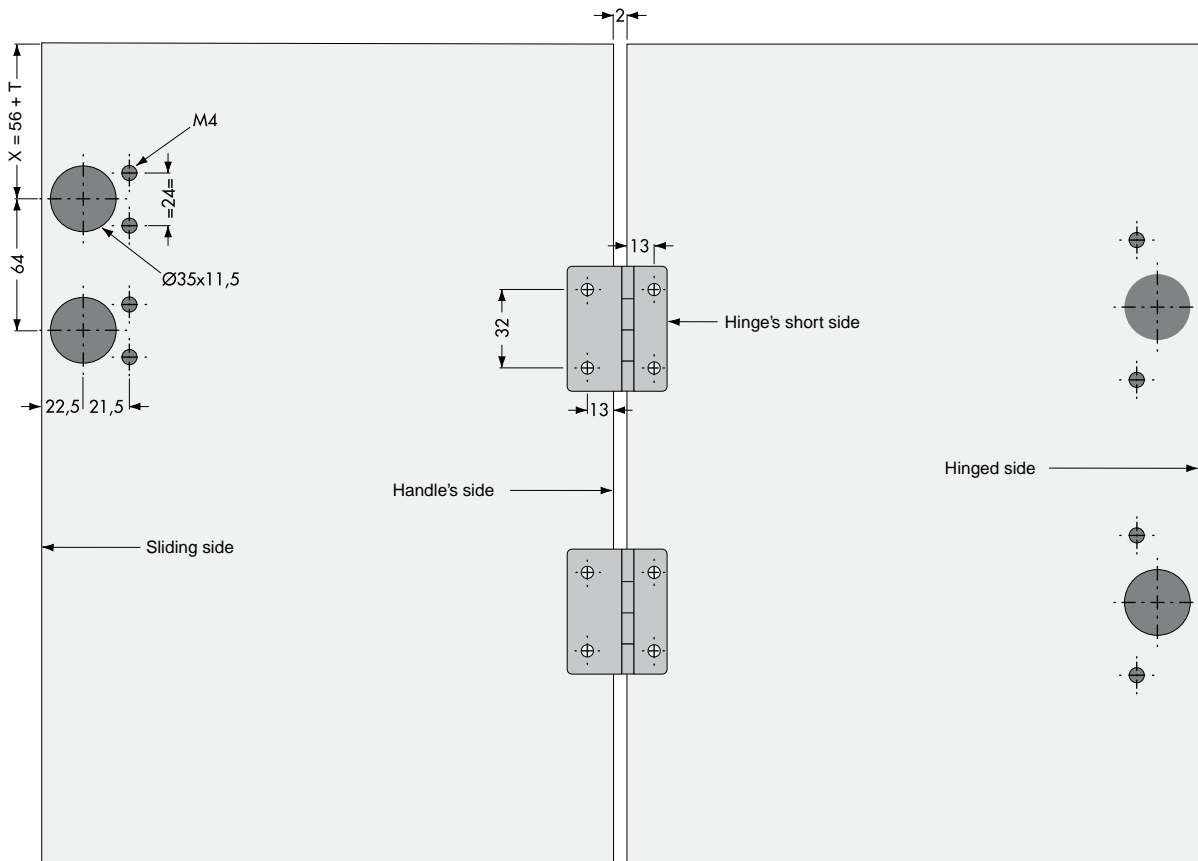
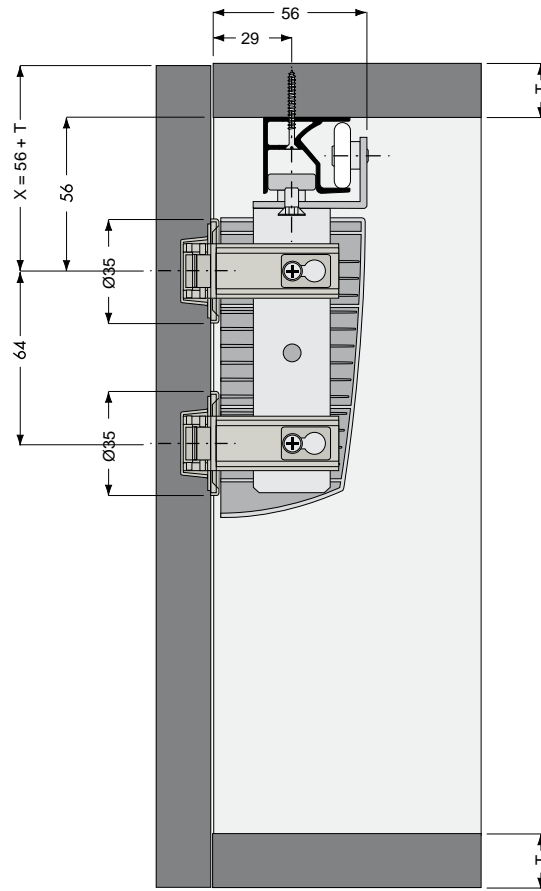

Section View:
Glass

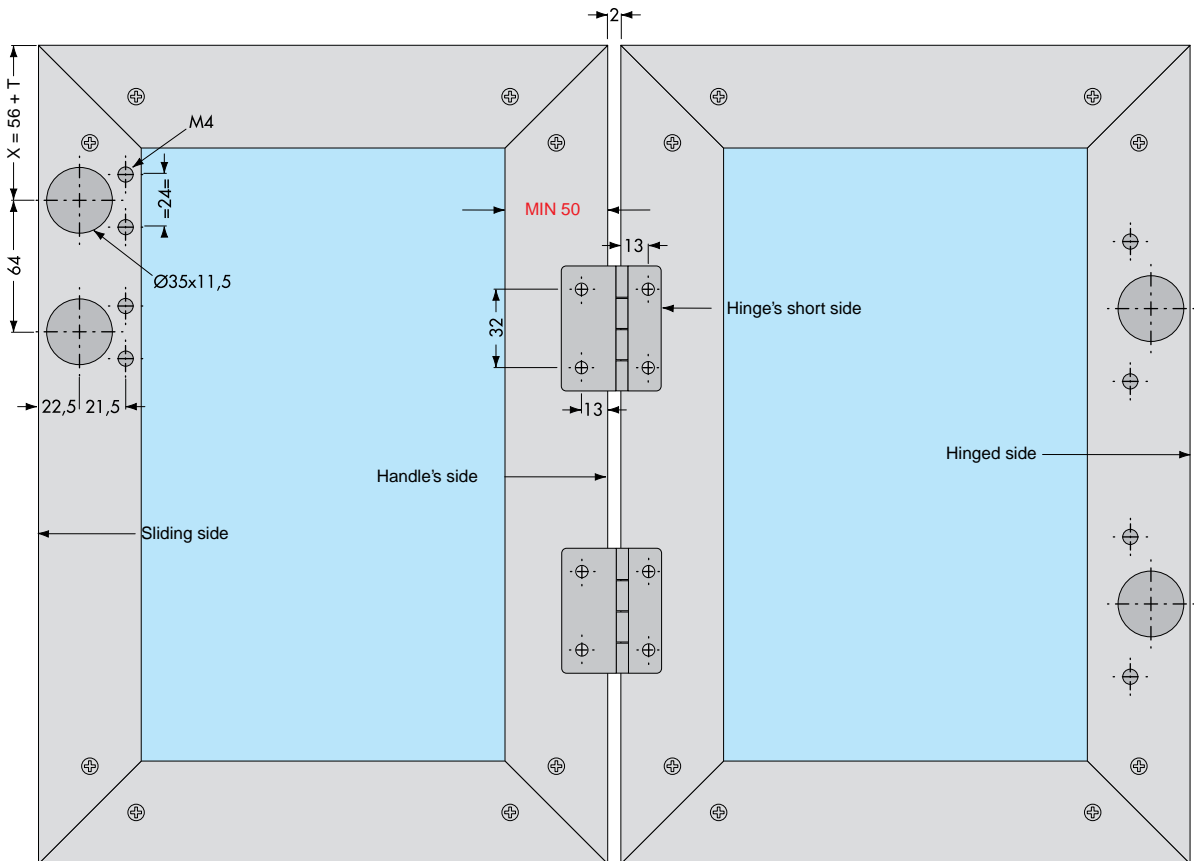
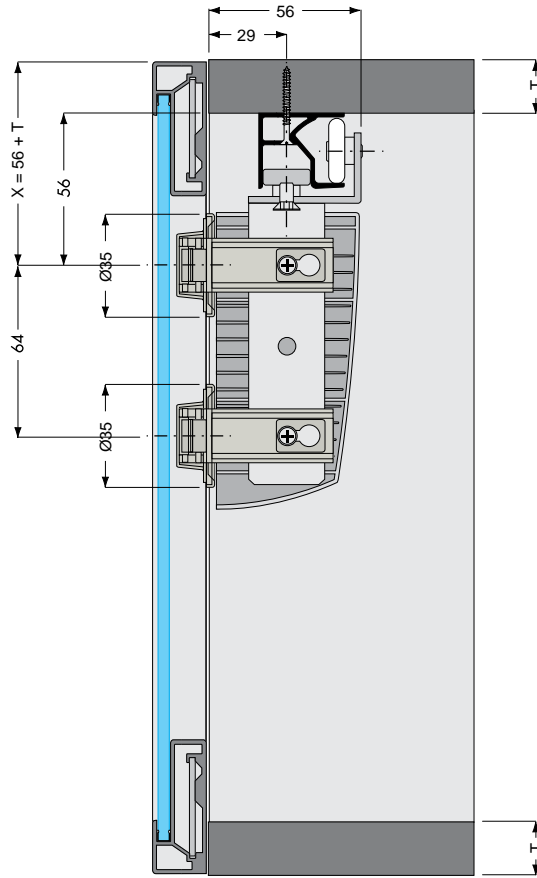

Application:

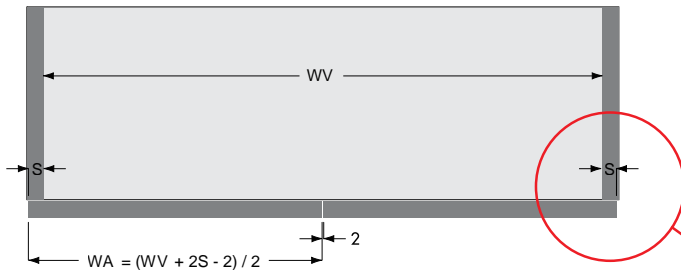

ABBREVIATIONS:
 WA = Half-Door width
 WV = Internal cabinet width
 S = Overlapping

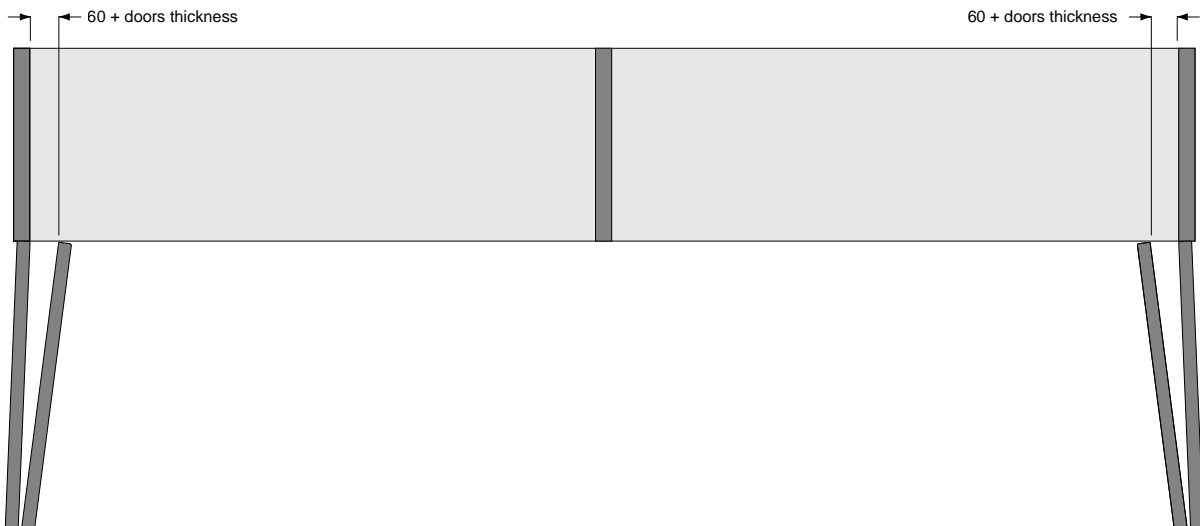
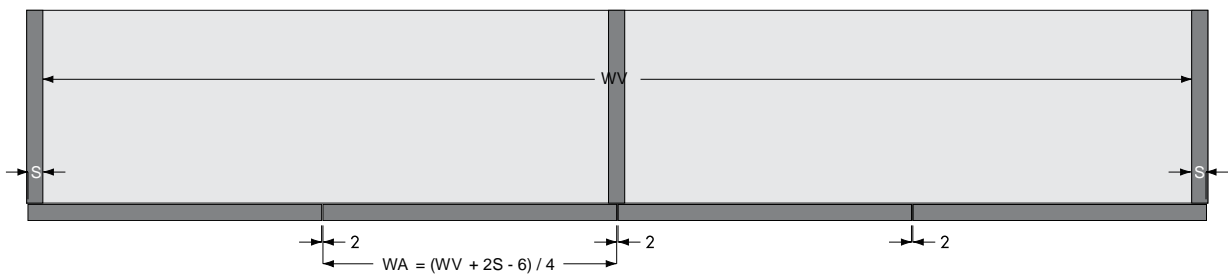
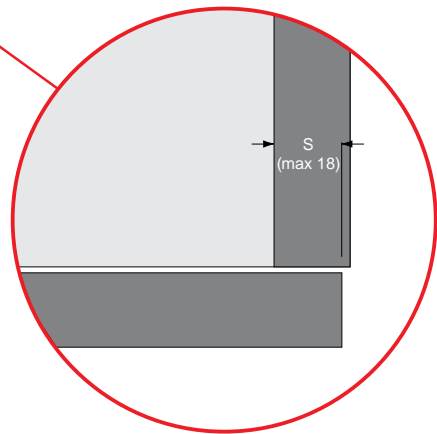

Carcass Drawing:

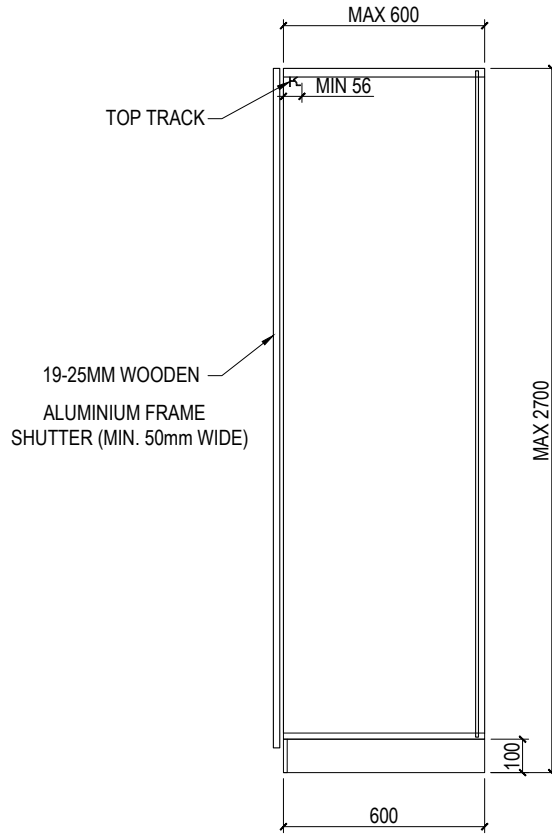

SECTION

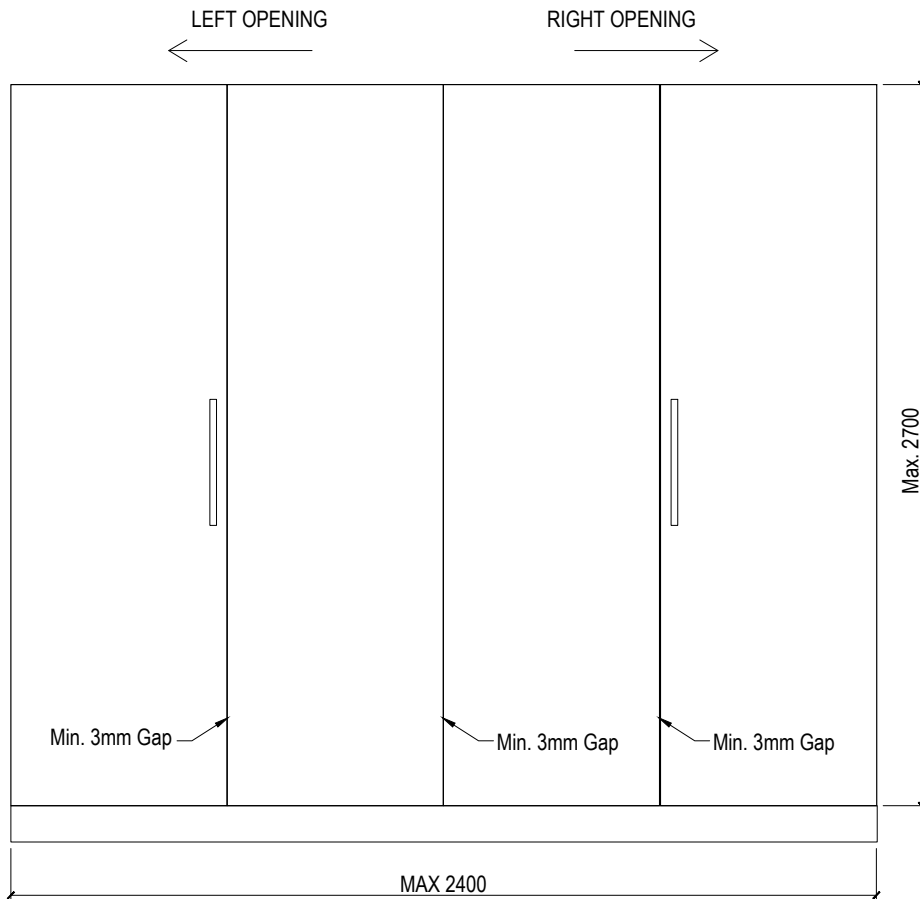

ELEVATION

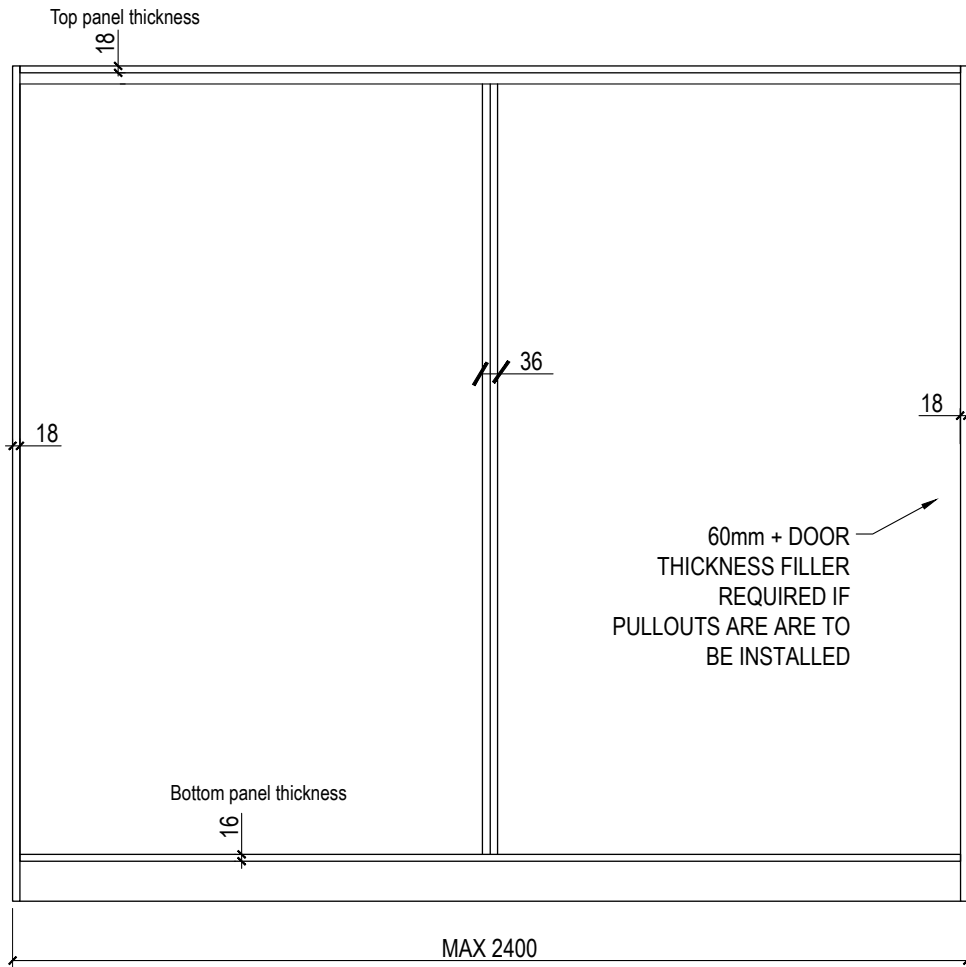

INTERNAL ELEVATION

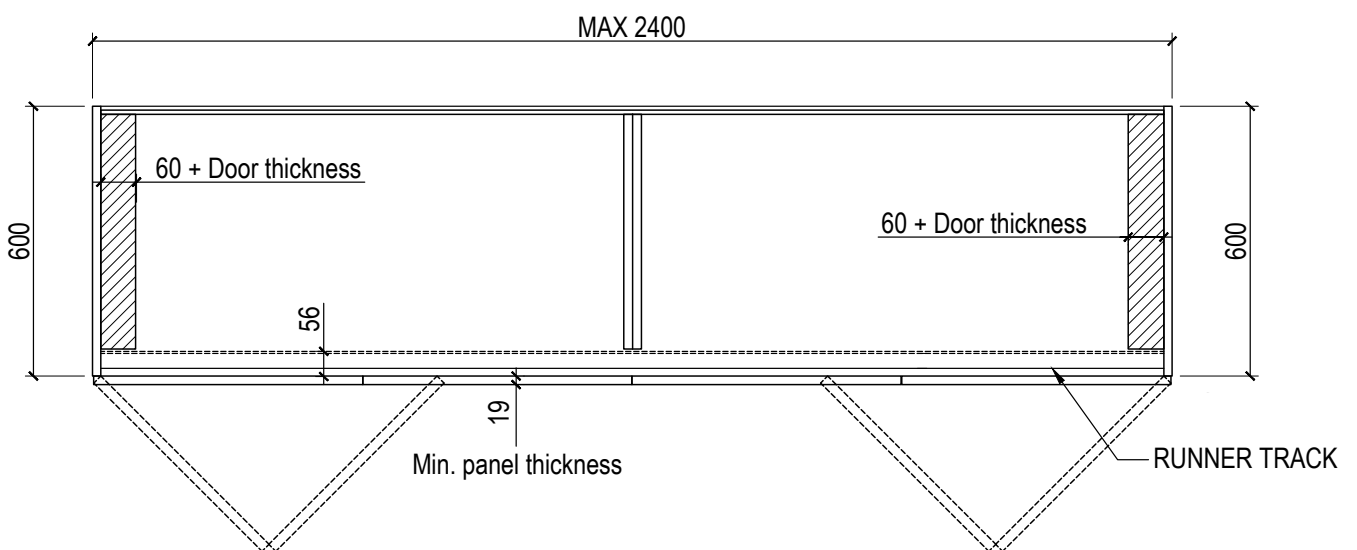

PLAN

*Carcass Dimension only for reference

Saliscendi

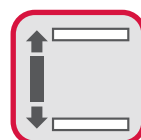

Vertical sliding system for wooden and glass doors.

Hardware Specification:

- Two door sliding system with doors opening upwards and downwards simultaneously
- Doors made of aluminium or wood
- Noiseless and smooth mechanism
- Side wall of the carcass behind the sliding mechanism should be 40 mm

Door Specification: In order to ensure smoothness and avoid obstruction, the width of the door must be maximum 5 times the height of the door
(Eg. H= 200 mm, maximum width =1000 mm)



Application:

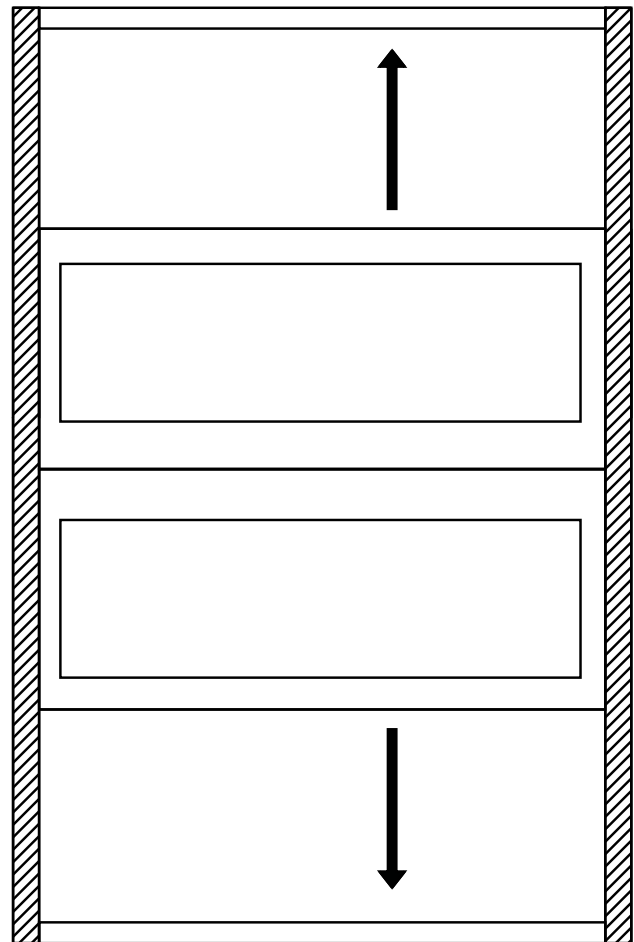
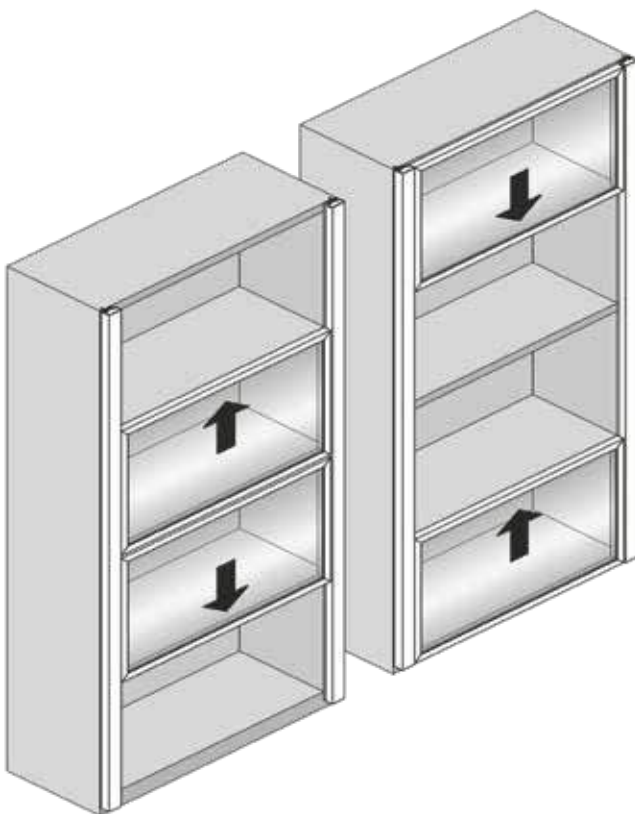

**Section View:
Wooden Door**

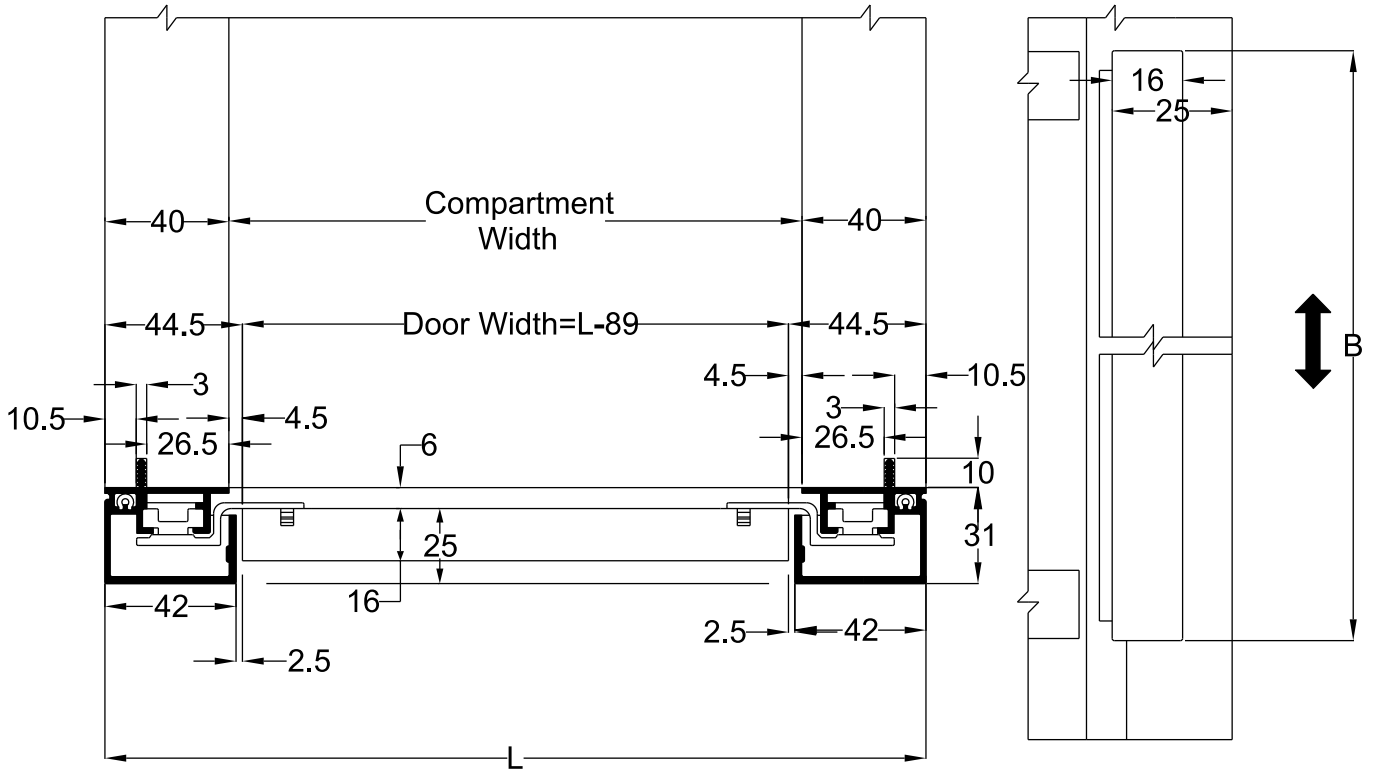

Aluminium Framed Glass Door

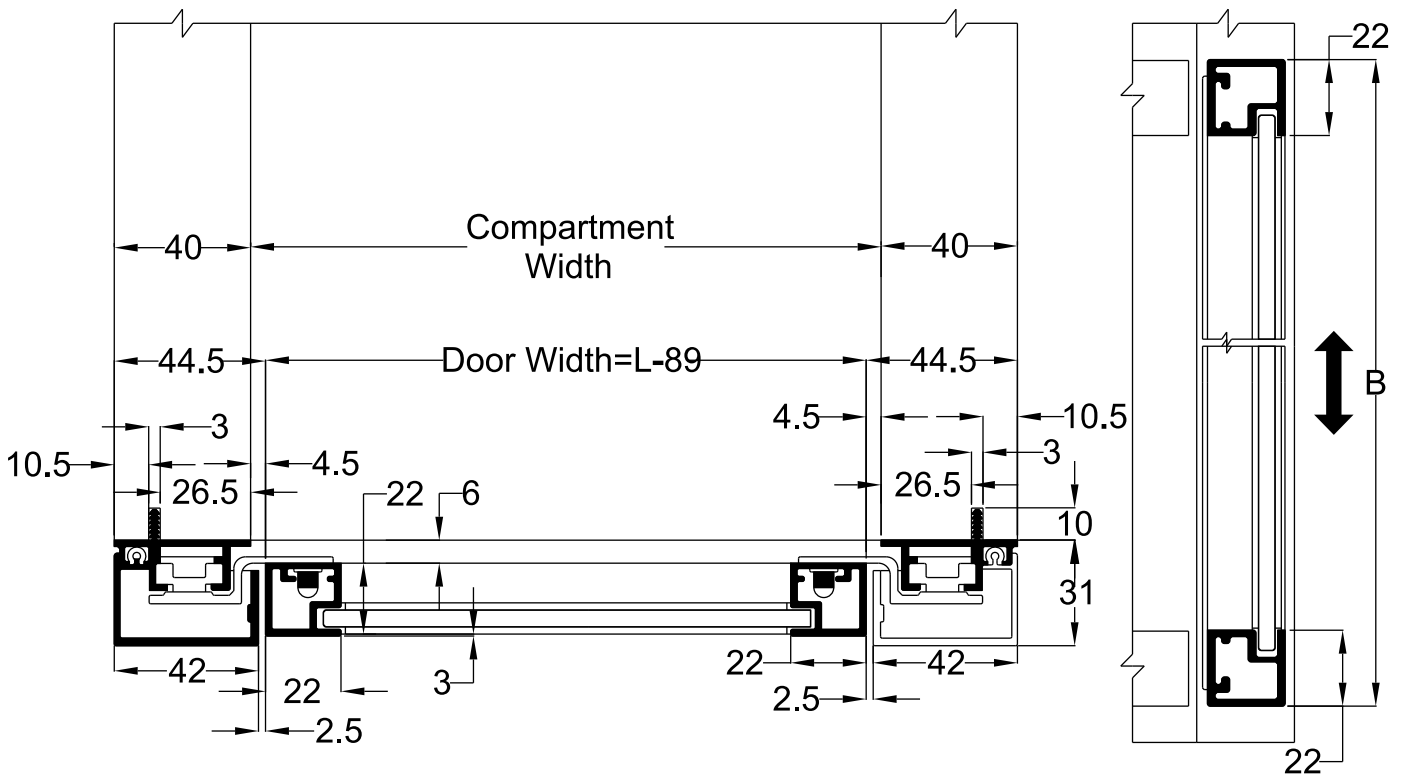

Duemezzi

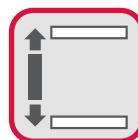
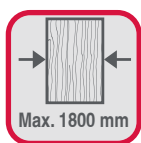
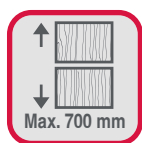

Vertical sliding system for wooden and glass doors.

Hardware Specification:

- Vertical sliding system with 2 equal aligned doors
- No counterbalances: the mechanism is balanced with identical doors
- Completely concealed fittings for better aesthetics
- Door Material: Glass, aluminium or wood
- This system is suitable for doors up to 1800mm in width
- The side panel of the unit should be 74mm shorter than depth (top & bottom panel)
- Recommended height of the system from 500mm to 700mm



Article No.: 403.30.006

For 2 Doors - Sliding door kit consists of:

- 2 Upper End Cap Pairs
- 2 Lower End Cap Pairs

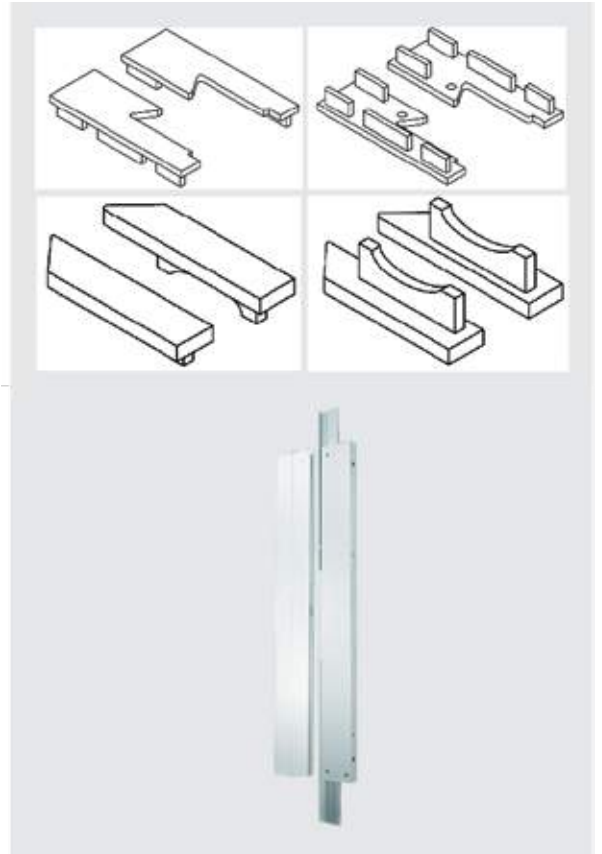

Application:

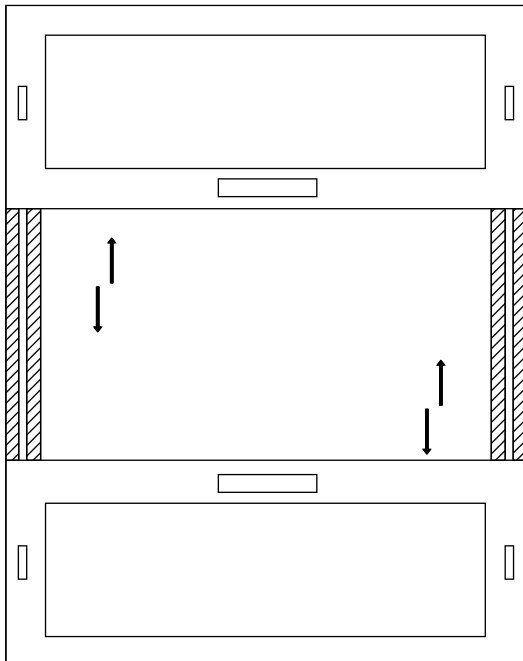

Section View:

Wooden Door

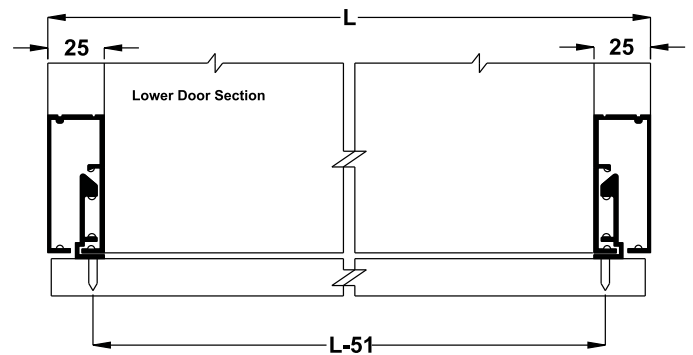
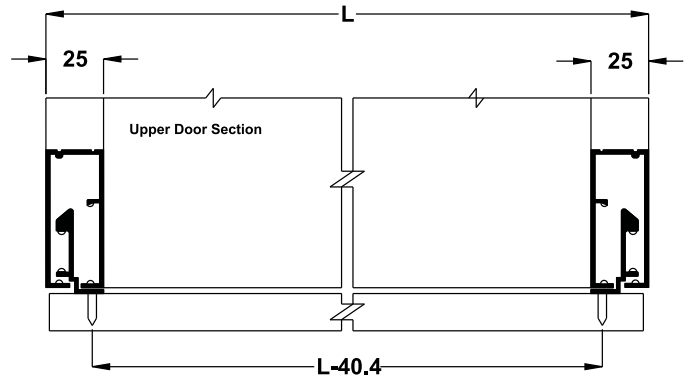



Design 50 VF SR (ST-18)

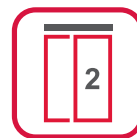
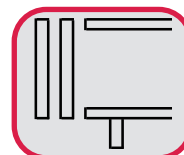

Vorfront sliding system for aluminium profile with glass and furniture doors

Hardware Specification:

- Smooth and effortless Sliding Doors
- Easy Installation
- Suitable for 2 door and 3 door applications



For 2 Doors - Article No.: 400.51.144

Door Thickness: 21mm

Sliding door kit consists of:

- 2 Running Gears with Ball Bearing
- 1 Running Gear for Inner Door
- 1 Running Gear with Pins
- 2 End Stoppers
- 2 Bottom Guides for Inner Door
- 2 Bottom Guides Adjustable
- 4 Clips for Guide
- 2 Support Blocks

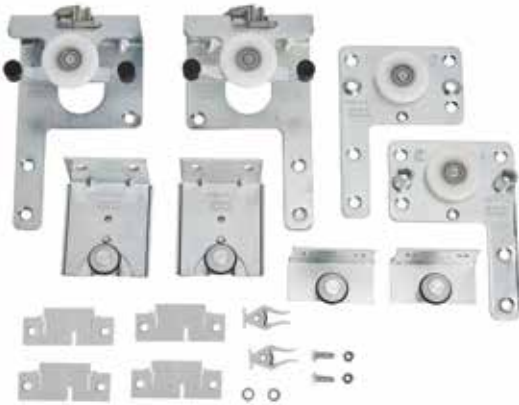

For 3 Doors - Article No.: 400.51.145

Door Thickness: 21mm

Sliding door kit consists of:

- 2 Running Gears with Ball Bearing
- 2 Running Gears for Inner Door
- 2 Running Gears with Pins
- 2 End Stoppers
- 4 Bottom Guides for Inner Door
- 2 Bottom Guides Adjustable
- 6 Clips for Guide
- 2 Support Blocks



For 2 Doors - Article No.: 400.51.141

Door Thickness: 27 mm

Sliding door kit consists of:

- 2 Running Gears with Ball Bearing
- 1 Running Gear for Inner Door
- 1 Running Gear with Pins
- 2 End Stoppers
- 2 Bottom Guides for Inner Door
- 2 Bottom Guides Adjustable
- 4 Clips for Guide
- 2 Support Blocks





For 3 Doors - Article No.: 400.51.143

Door Thickness: 27 mm

Sliding door kit consists of:

- 2 Running Gears with Ball Bearing
- 2 Running Gears for Inner Door
- 2 Running Gears with Pins
- 2 End Stoppers
- 4 Bottom Guides for Inner Door
- 2 Bottom Guides Adjustable
- 6 Clips for Guide
- 2 Support Blocks



Product Name	Article No.		
Silver anodized aluminium top track (Note: Track to be ordered separately)	400.52.026	2500 mm	
	400.52.036	3500 mm	
Silver anodized aluminium bottom track (Note: Track to be ordered separately)	400.52.952	2500 mm	
	400.52.953	3500 mm	

Note: Shutter profile to be ordered separately

Section View:
Installation dimensions

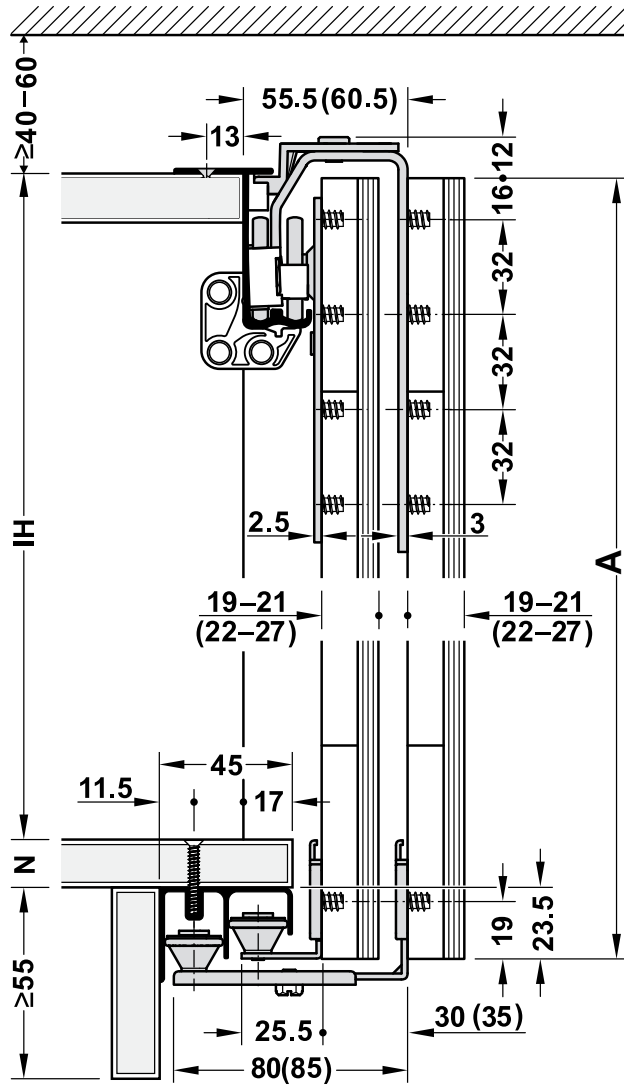

A = Door height

IH = Internal cabinet height + Top panel thickness

N = Cabinet base panel thickness

Calculation: $A = IH + N + 23.5 \text{ mm}$

Carcass Drawing

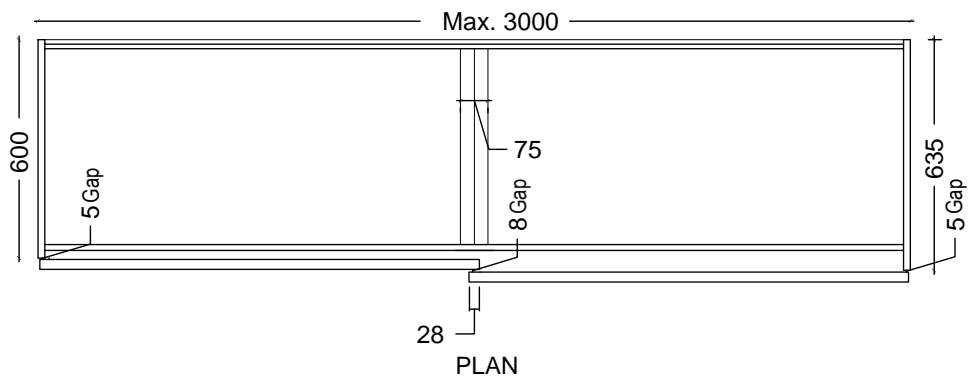

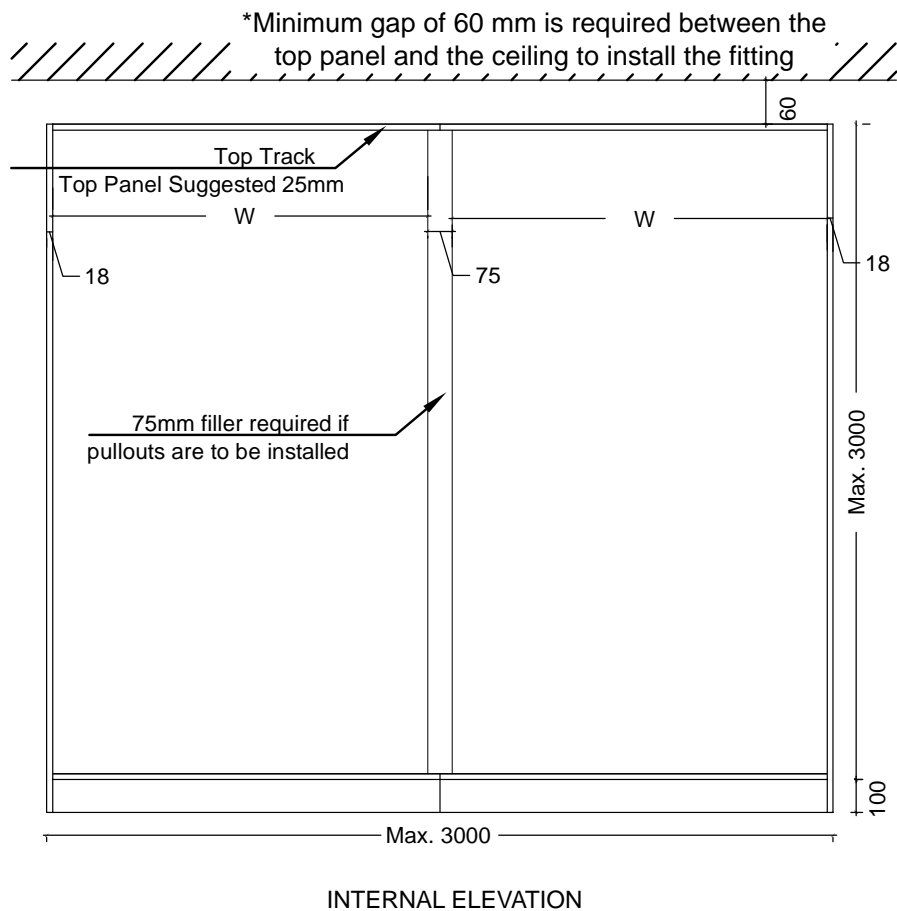
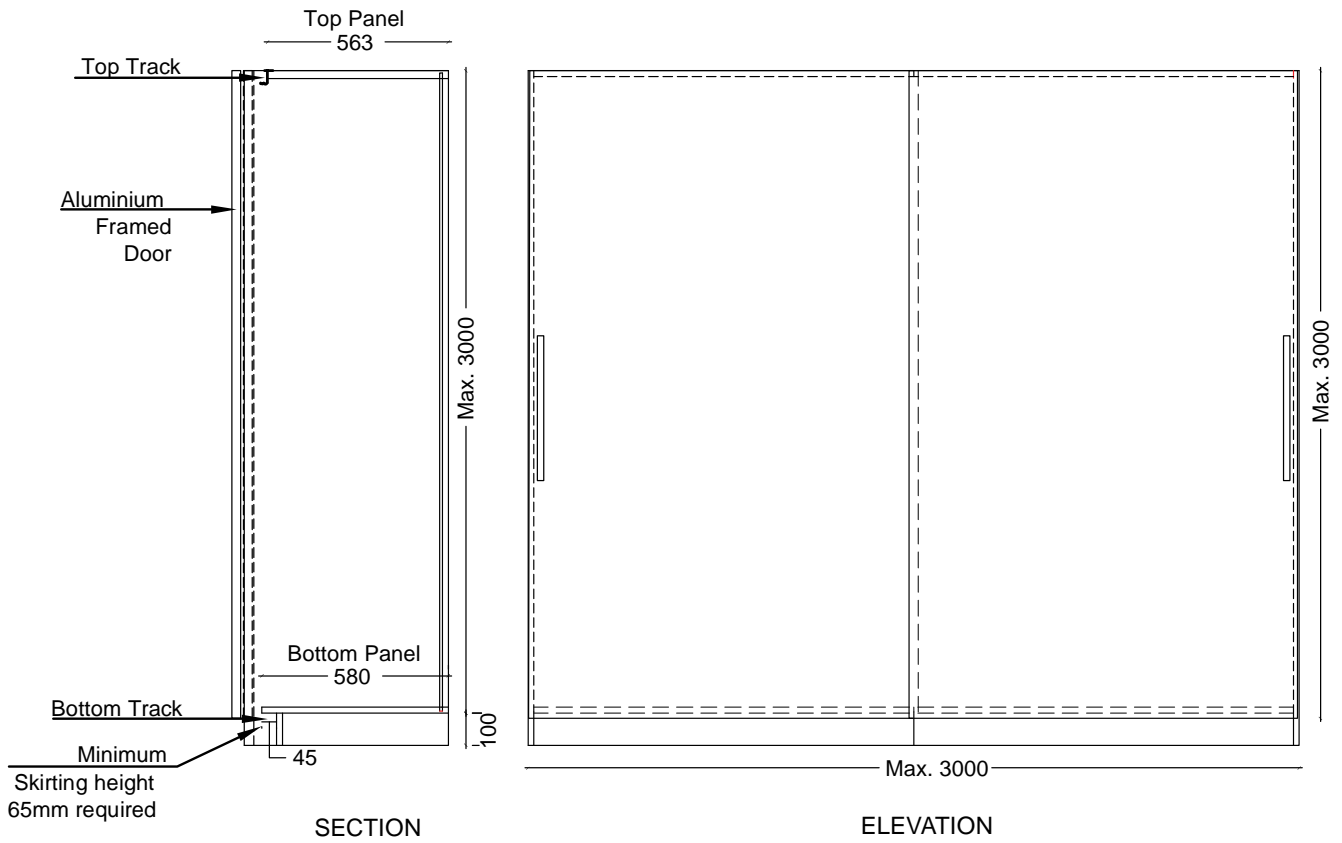

*Carcass Dimension only for reference

Design 60 VF

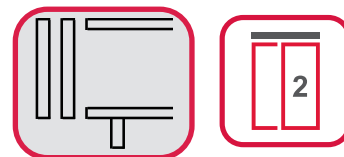

Flush (Vorfront) sliding system for aluminium profile with glass/wooden wardrobe and furniture doors.

For E-Drive please refer to Page No.: 239

Hardware Specification:

- 100% Flexibility:
 - No work of millings or drillings on upper and lower rails
 - No special construction of the cabinet
 - Standard stock management (one type profile and kit)
- Easy assembly:
 - The mechanism is inserted in the rail before fixing it on the cabinet
 - Vertical Adjustments: +6mm/ -4mm
 - Softspace: Soft closing & opening

Note: If you place the order using the individual components (as listed below), please order the track separately. Alternately if you place the order using the BOM Articles (mentioned in the BOM LIST table), the track is included.



For Left Door- Article No.: 400.50.008

Slide kit for left door 1 pair consists of:

- 1 Steel Upper Slide
- 1 Steel Lower Slide
- 2 Zamac Hooking Device
- 2 Fixing For Lower Slide
- 1 Plastic Upper Lock
- 1 Zamac Lower Lock
- 1 Door Corner Spacers Kit

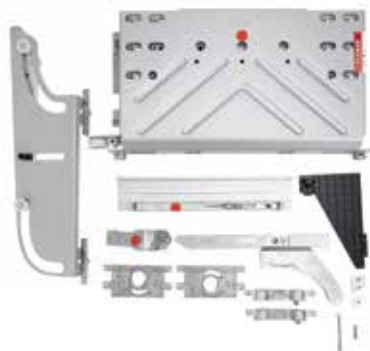





For Right Door - Article No.: 400.50.001

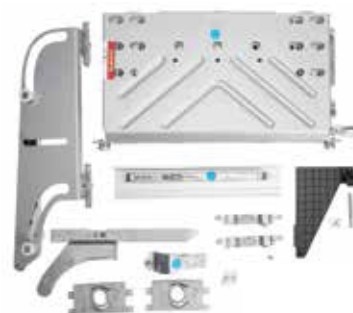

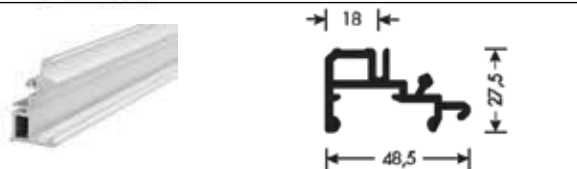
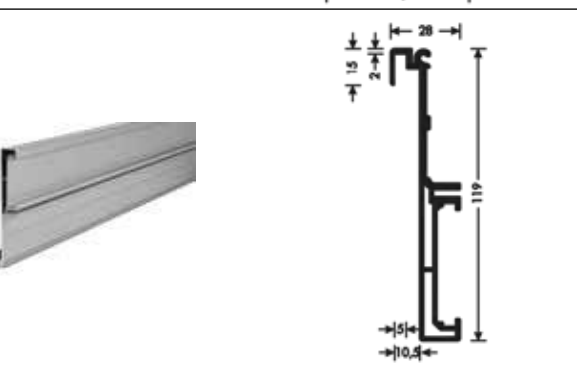
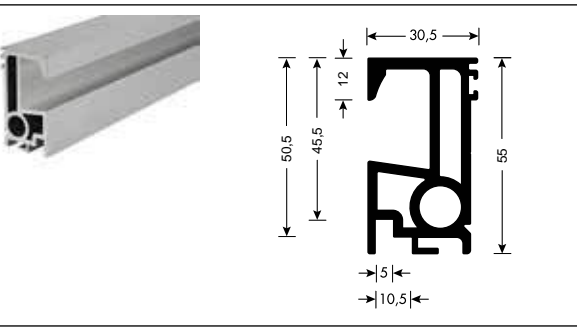
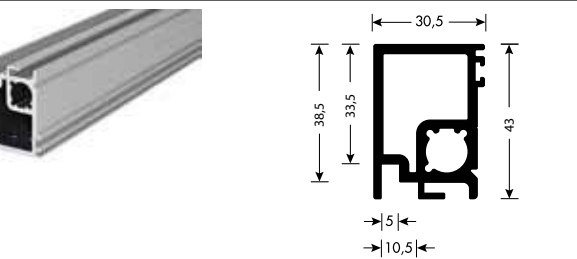

Slide kit for right door 1 pair consists of:

- 1 Steel upper slide
- 1 Steel lower slide
- 2 Zamac hooking device
- 2 Fixing for lower slide
- 1 Plastic upper lock
- 1 Zamac lower lock
- 1 Door corner spacers kit

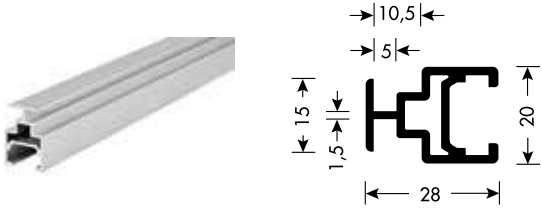

SOFTSPACE Device Kit with Activator
(Note : Available in the kit)

Product Name	Article No.		
Aluminium upper rail	409.50.600	3050mm	
Aluminium lower rail	409.50.800	3050mm	
Upper and lower cross profile	400.50.539	3050mm	
Vertical rod profile with handle	400.50.540	3050mm	
Vertical rod profile	400.50.541	3050mm	
Kit plates for steel and aluminium	400.50.037		
Kit of aluminum fixing plates for middle crossbeam	400.50.400		

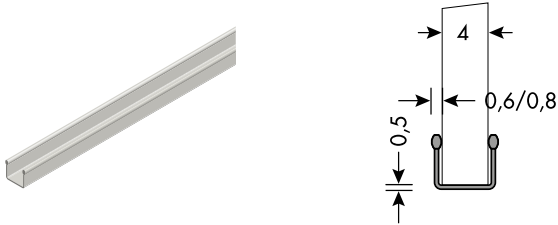
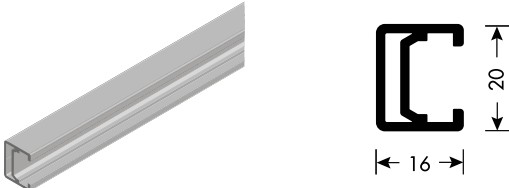
Product Name	Article No.	L mm 	
Middle crossbeam alu profile with glass or wood panel seat	400.50.932	3050mm	
Kit straightner door device for threaded bar	400.50.402		
Threaded bar M5 for straightner device bundle of 2 bars	400.50.403		
Save dust brush	400.50.503		
Gasket for glass length 3m	400.50.450		
*Hidden aluminium cross beam	400.50.933	3050mm	

* Note: 1) For single wooden panel use Article no. 400.50.933 (Silver Anodised Aluminium) at distance of 450mm (Not applicable in case of glass)
2) For Glass use standard horizontal profiles

BOM LIST (Track Included)	
Description	Article No.
Design 60 VF for 2 doors with 3 mtr track	400.50.018

Section View:

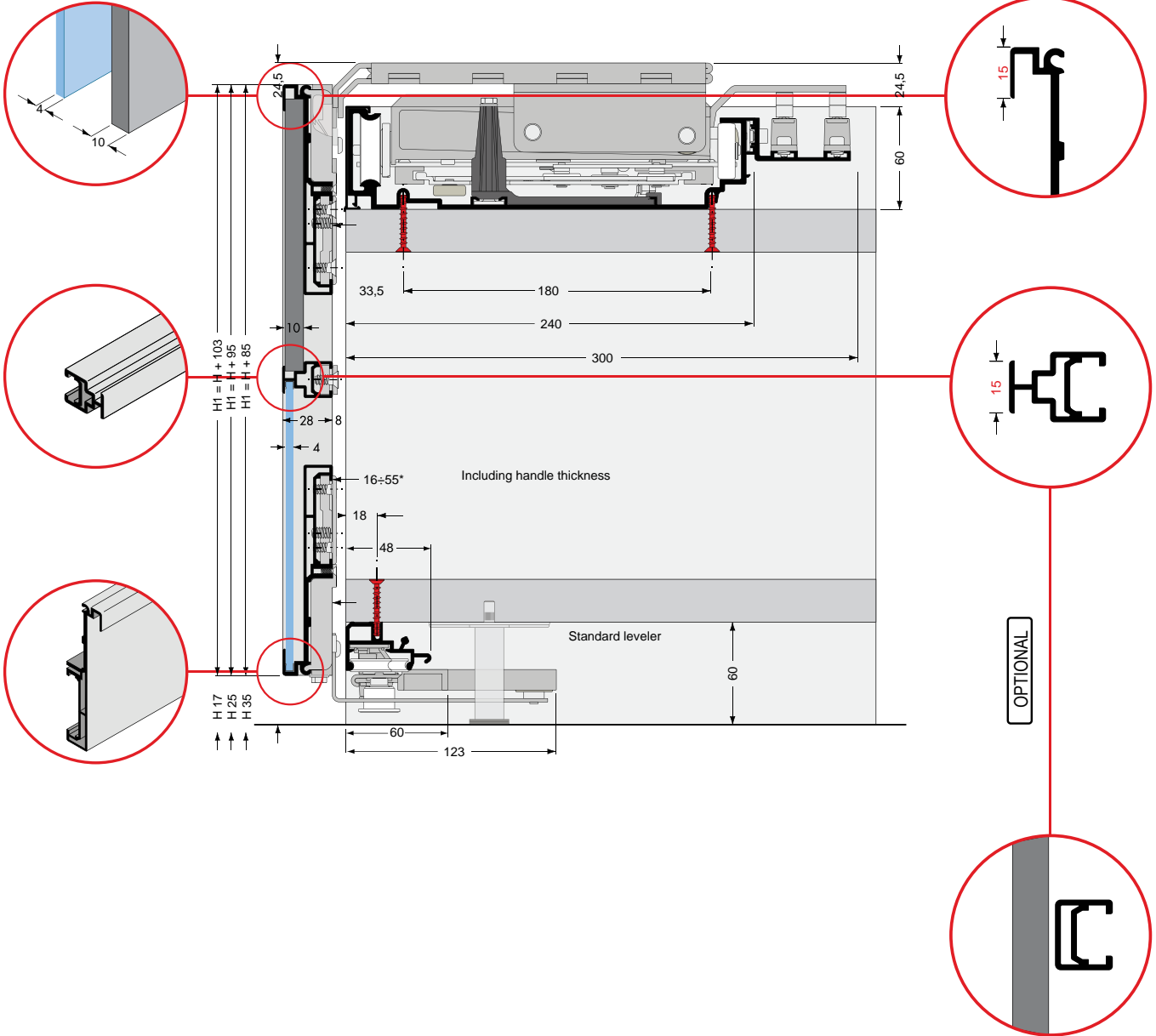

Design 60 VF - Door Thickness	
Wood	10mm
Glass	4mm

Application:

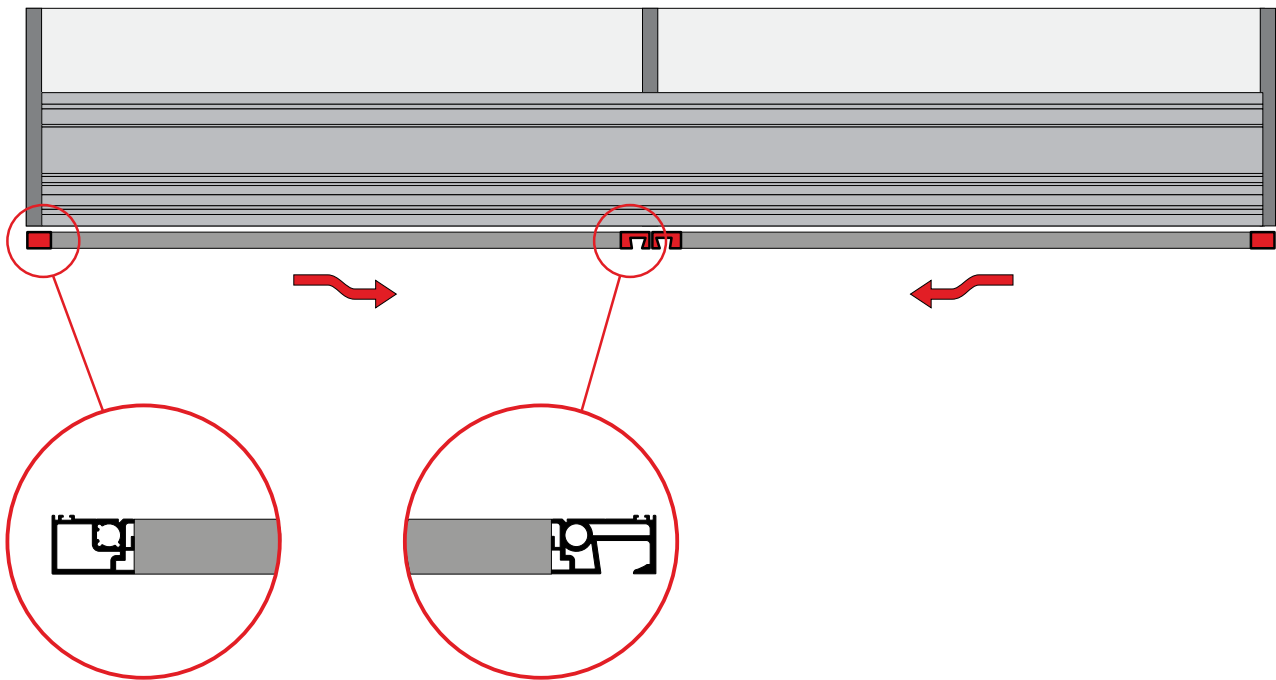

ABBREVIATIONS:
 W = Width
 WP = Panel width
 WV = Glass width
 H1 = Height
 HP = Panel height
 HV = Glass height

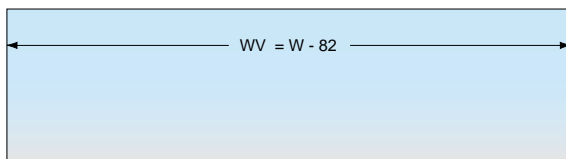
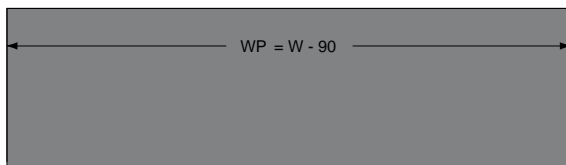
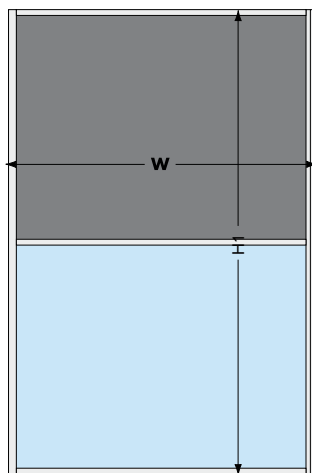

Calculation of the dimensions of glasses and wooden panels divided in equal parts.

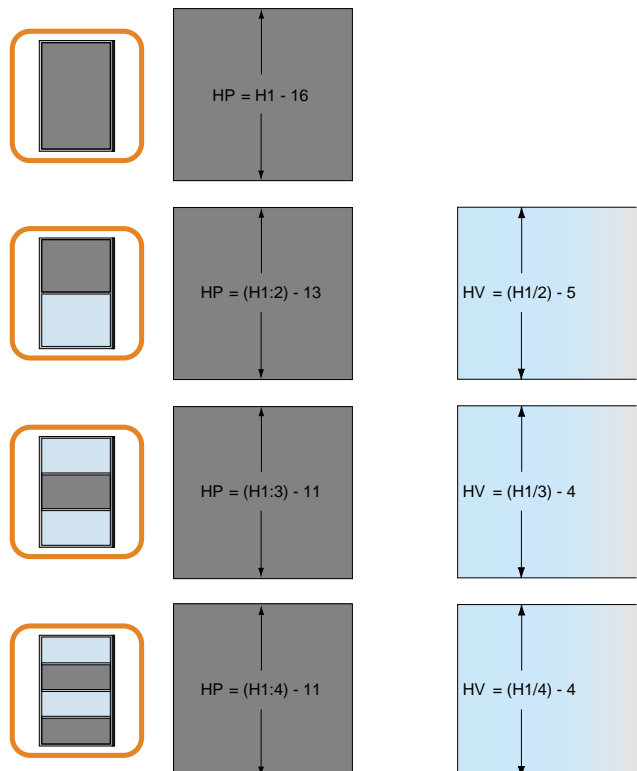

Carcass Drawing:

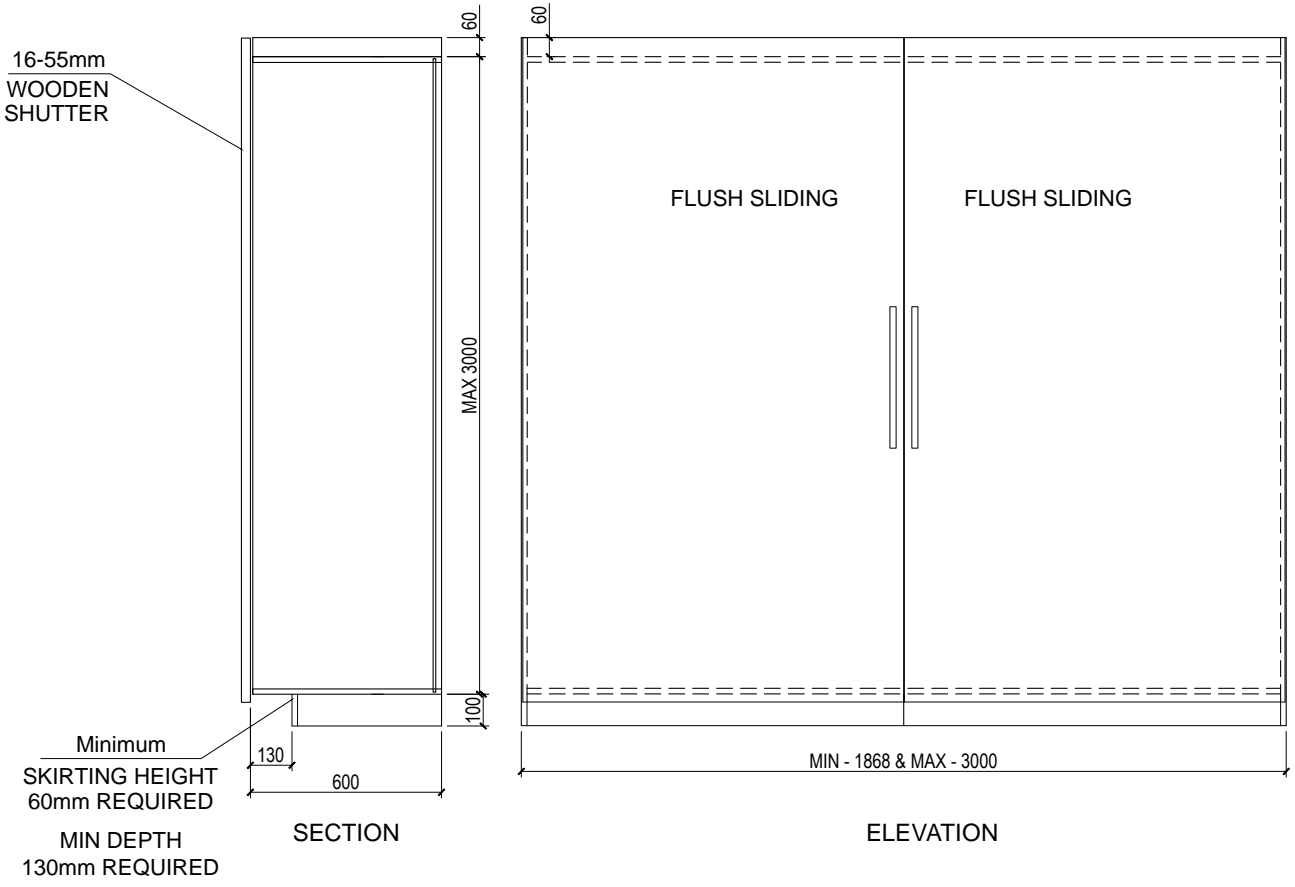

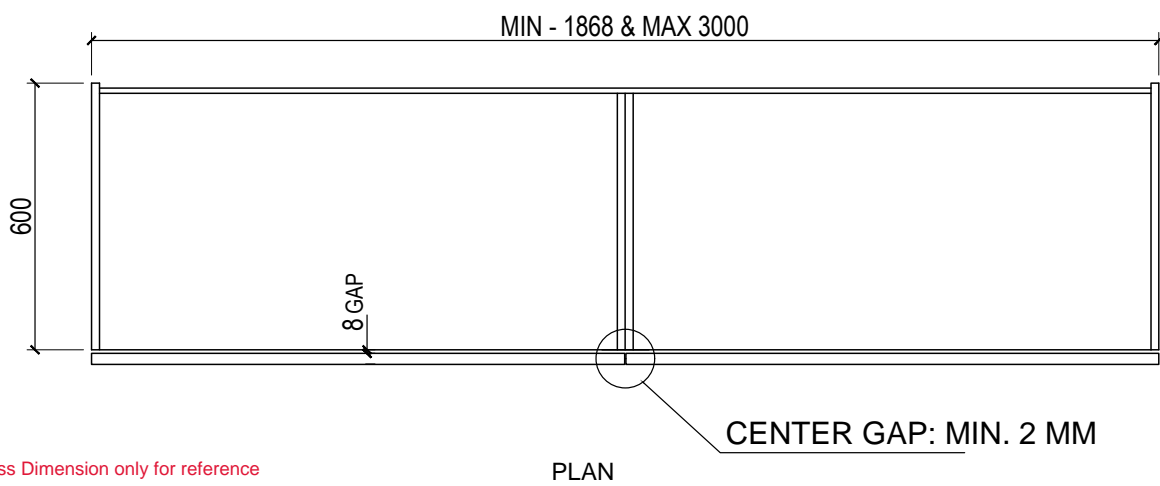
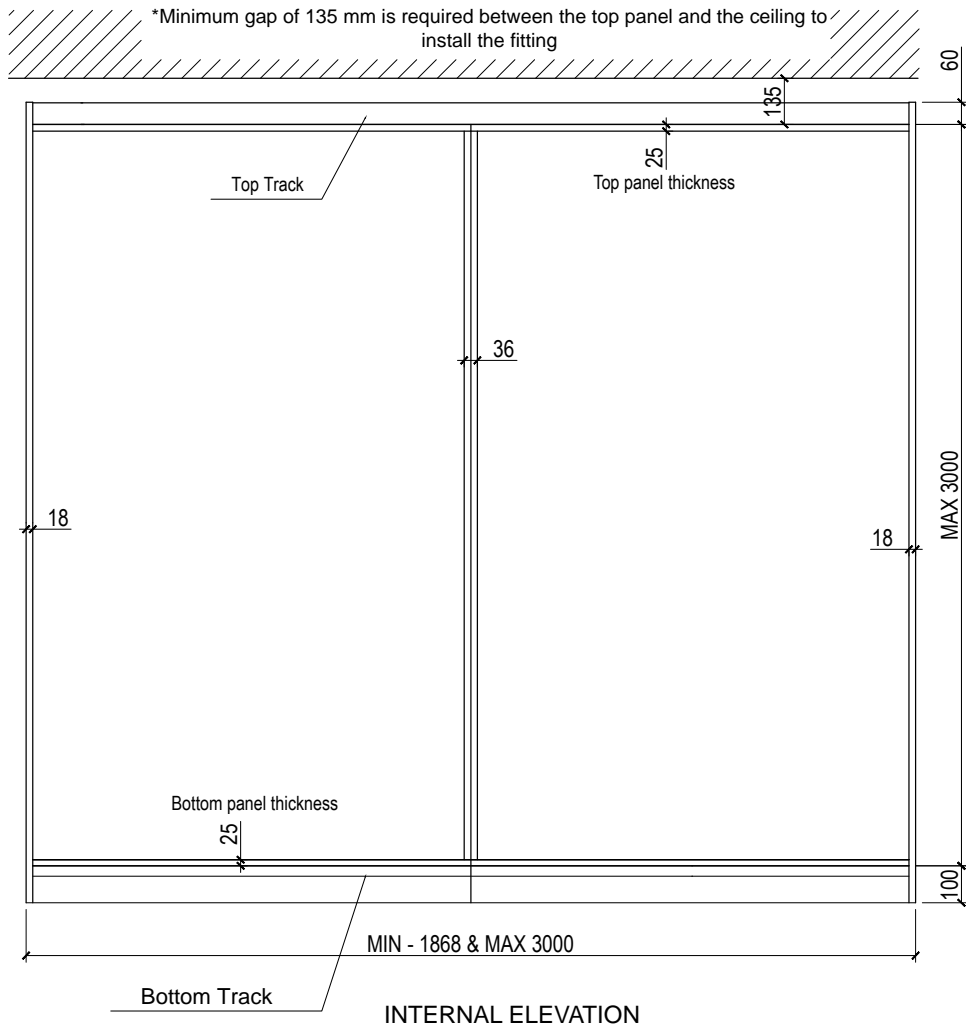

*Carcass Dimension only for reference

NEW Design Duo 80 VF

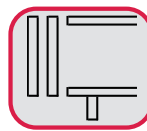
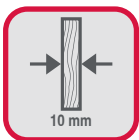
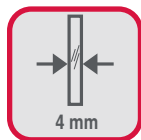
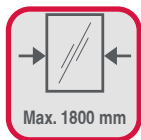

Aluminium profiled sliding systems for glass furniture and wardrobe doors.

For E-Drive please refer to Page No.: 239

Hardware Specification:

- High load capacity up to 80 kg
- More than one adjustment
- Door thickness: 28mm
- Anti derailing system inside the lower slide
- Provides easy way to mount heavy doors onto the furniture with just a clack
- Adjustment: +3mm/-3mm (vertical adjustment)
- Soft Closing: opening and closing



Note: If you place the order using the individual components (as listed below), please order the track separately. Alternately if you place the order using the BOM Articles (mentioned in the BOM LIST table), the track is included.



Article No.: 409.36.112

External door kit consists of:

For Door Thickness of 28 mm

- 2 Steel Adjustable Upper Slide
- 2 Steel Lower Slide with Wheel and O-Ring
- 1 Right Plastic Adjustable Upper Lock
- 1 Left Plastic Adjustable Upper Lock
- 1 Plastic Upper Central Lock.
- 2 Plastic Lower Lock
- 1 Rounded Socket Key with 4 mm Hexagonal Ends



Article No.: 409.36.111

Internal door kit consists of:

- 2 Steel Adjustable Upper Slide
- 2 Steel Lower Slide with Wheel and O-Ring
- 1 Right Plastic Adjustable Upper Lock
- 1 Left Plastic Adjustable Upper Lock
- 1 Plastic Upper Central Lock.
- 2 Plastic Lower Lock
- 1 Rounded Socket Key with 4 mm Hexagonal Ends



Only for 3 Door Application

Article No.: 409.36.050

For door thickness of 28 mm

External central double side soft close door kit consists of:

- 2 Steel Adjustable Upper Slide
- 2 Steel Lower Slide with Wheel and O-Ring
- 1 Right Plastic Adjustable Upper Lock
- 1 Left Plastic Adjustable Upper Lock
- 1 Plastic Upper Central Lock.
- 2 Plastic Lower Lock
- 1 Rounded Socket Key with 4 mm Hexagonal Ends



SOFTSPACE Device For External & Internal Door
(Note: Available in the kit)



Accessories

Article No.: 400.50.504

External Door Save- Dust Plastic Profile

Length : 3000 mm

Article No.: 400.50.505

White Tape Bi- adhesive

Length : 40 X 10 X 1.5 for Save Dust Plastic Profile

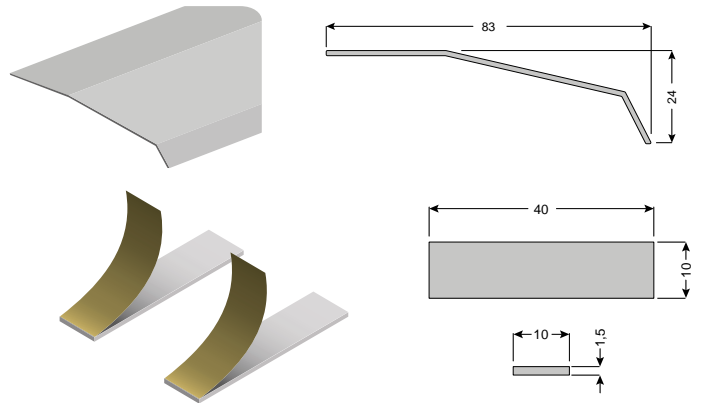





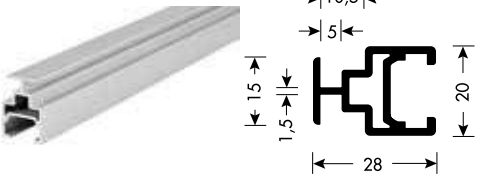
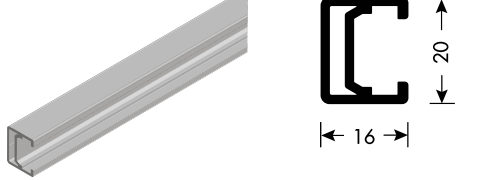

Product Name	Article No.	L mm	
Silver anodized aluminium top track	409.36.606	3000 mm	
	409.36.604	3600 mm	
Silver anodized aluminium bottom track	400.50.936	3000 mm	
	400.50.804	3600 mm	

Product Name	Article No.	Finish	L mm	
Upper and lower cross aluminium profile	400.50.931	Silver anodised aluminium	3050 mm	
Vertical aluminium profile without handle	400.50.927	Silver anodised aluminium	3050 mm	
Vertical aluminium profile with handle	400.50.926	Silver anodised aluminium	3050 mm	
Vertical aluminium profile with handle and side gap cover	400.50.928	Silver anodised aluminium		

Product Name	Article No.	Finish		
Middle cross beam aluminium profile with glass/wood panel seat	400.50.932	Silver anodised aluminium		
*Hidden aluminium cross beam	400.50.933	Silver anodised aluminium	3050mm	

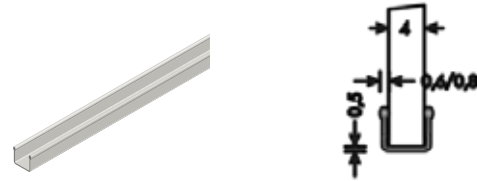
* Note: 1) For single wooden shutter use Article no. 400.50.933 at distance of 450mm (Not applicable in case of glass)
 2) For Glass use standard horizontal profiles

Product Name	Article No.	
Kit for assembly of horizontal cross profile	400.50.400	
Kit plates for assembly of external door	400.50.007	
Kit plates for assembly of internal door	400.50.002	
Straighten door gear for threaded bar	400.50.402	
Threaded bar M5	400.50.403	
Gasket for glass	400.50.450	
Save dust brush	400.50.503	

Section View:

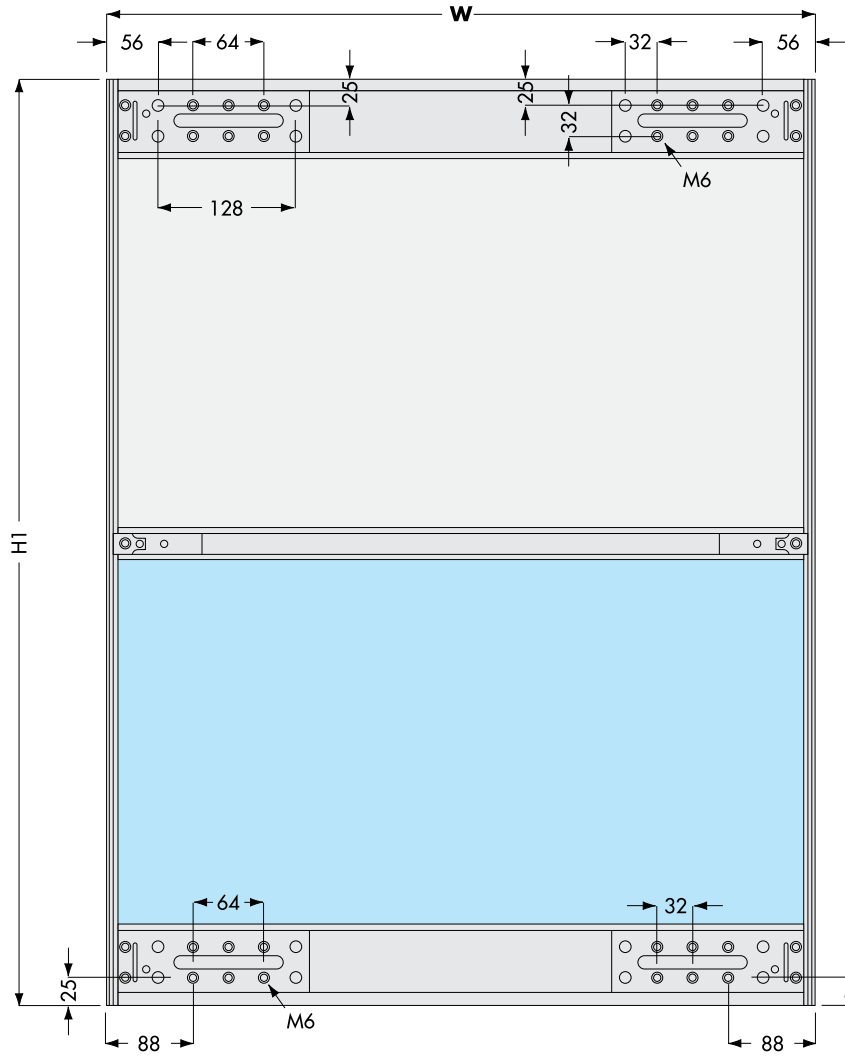

Application:

- ABBREVIATIONS:**
 W = Width
 WP = Panel width
 WV = Glass width
 H1 = Height
 HP = Panel height
 HV = Glass height

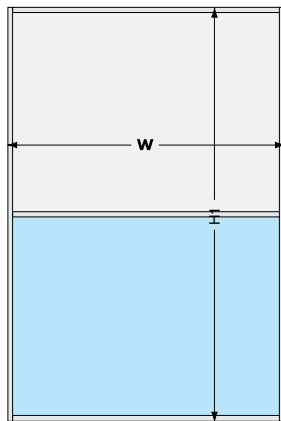

Calculation of the dimensions of glasses and wooden panels divided in equal parts.

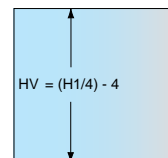
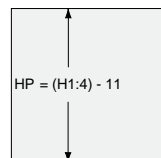
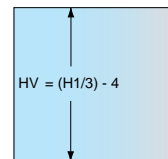
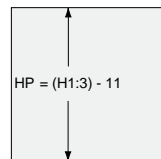
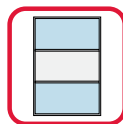
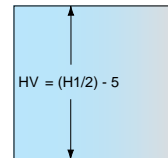
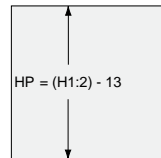
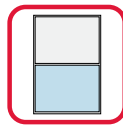
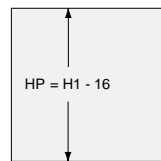
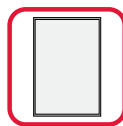
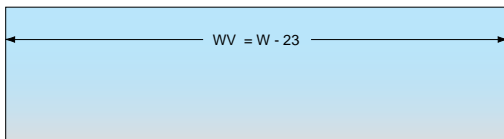
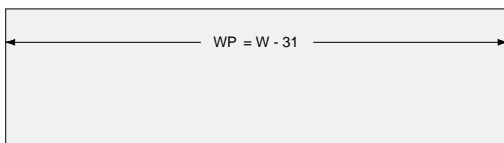

Carcass Drawing:

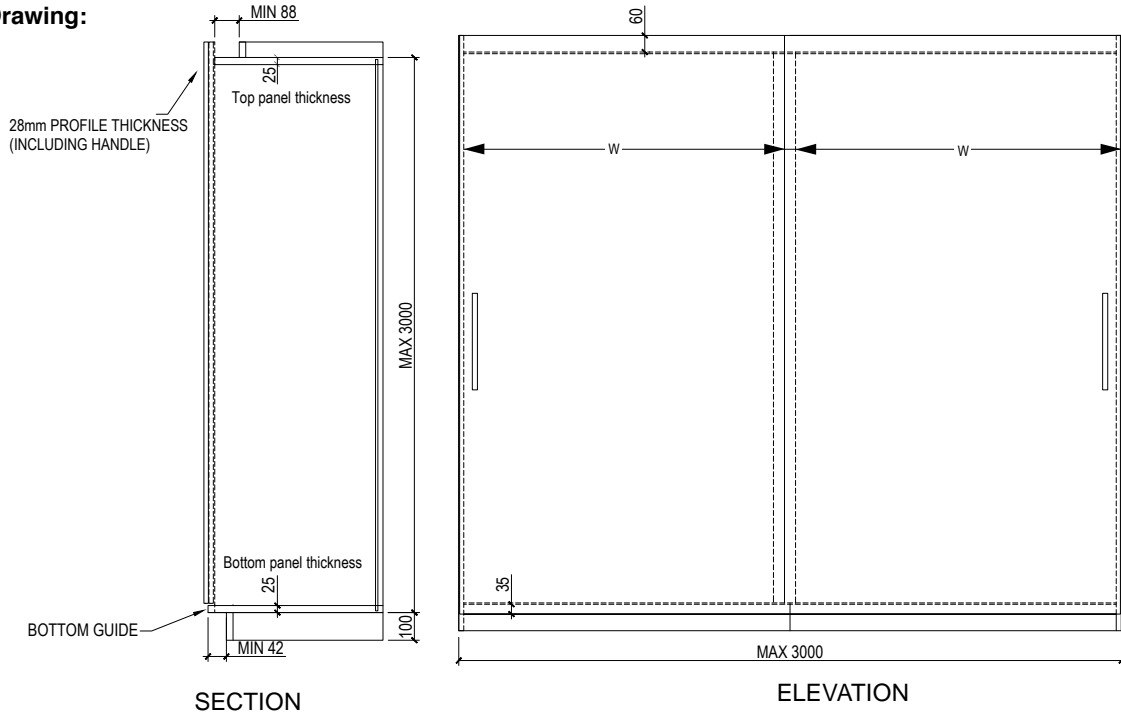

SECTION

ELEVATION

*Minimum gap of 135 mm is required between the top panel and the ceiling to install the fitting

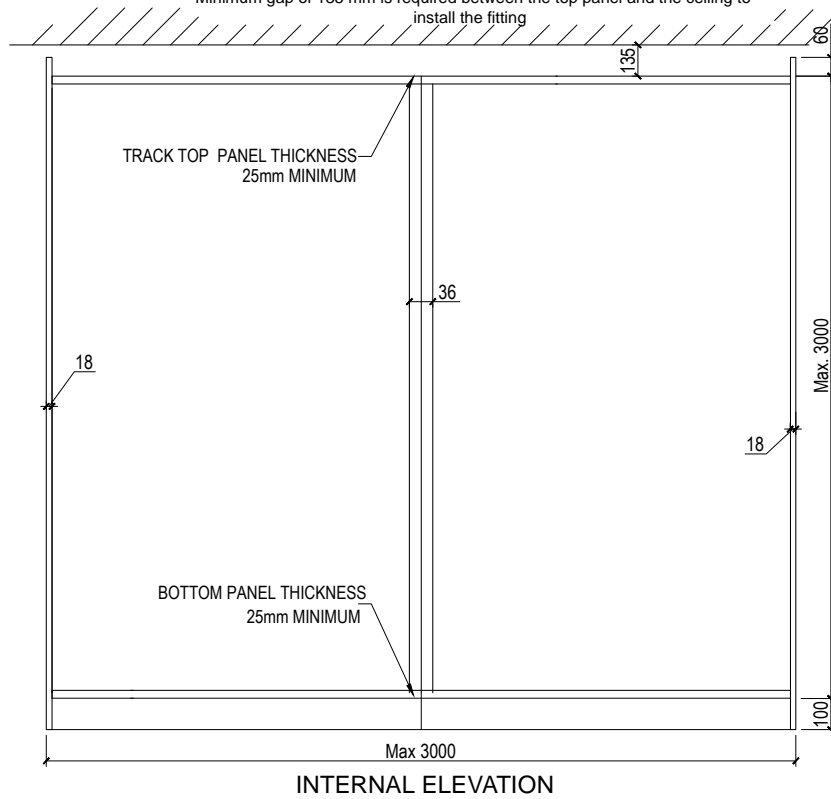

INTERNAL ELEVATION

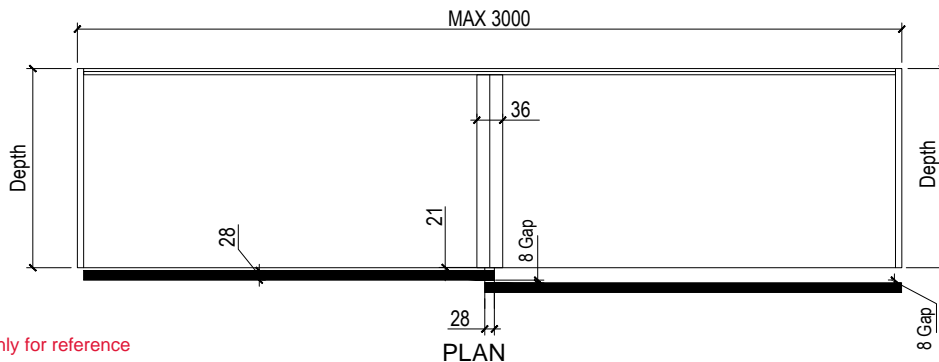

PLAN

*Carcass Dimension only for reference

NEW E Drive



Classic 50 VF S/ SR
Classic 60 VF - Design 60 VF
Classic Duo 80 VF - Design Duo 80 VF





Classic 50 VF S/ SR

E Drive for Classic 50 VF S/ SR

Hardware Specification:

- 1 Motorised Drive Track
- 1 Cable
- 1 Power Supply Unit
- 1 Adapter
- 1 Adapter Cable

***Additional Hardware Specification:**

- 1 Connecting Arms
- 1 Internal Roller
- 1 External Roller

* To be ordered separately

Technical Specifications:

- Only for 2 doors.
 - Version: plug-and-go connection
 - Cabinet width: For 2 doors 1600-2400/ 2400-4000 mm,
 - Door weight: 20-100 kg
 - Nominal voltage: 100–240 V AC, 50/60 Hz, standby power <1 W
 - Wattage: 25.0 W
 - Voltage: 12 V
 - Features: Integrated safety shut-off, opening speed 0.2 m/s, closes automatically after 2 minutes, a gentle tap opens one door and closes the other one, if open.
- (Not applicable for Design 50 VF SR)**



For Cabinet Width 1600-2400mm

Article No.: 405.15.000



- 1 Motorised Drive Track
- 1 Cable
- 1 Power Supply Unit
- 1 Adapter
- 1 Adapter Cable

For Cabinet Width 2400-4000mm

Article No.: 405.15.001

- 1 Motorised Drive Track
- 1 Cable
- 1 Power Supply Unit
- 1 Adapter
- 1 Adapter Cable



Product Name	Article No.	
Connecting Arms	405.15.102*	
External Roller	405.15.201*	
Internal Roller	405.15.200*	

* Necessary to order for E drive installation along with standard articles (Classic 50 VF S/SR)

Connecting arms

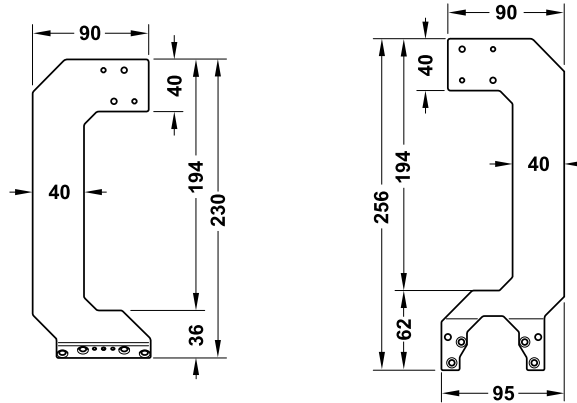

Elevation

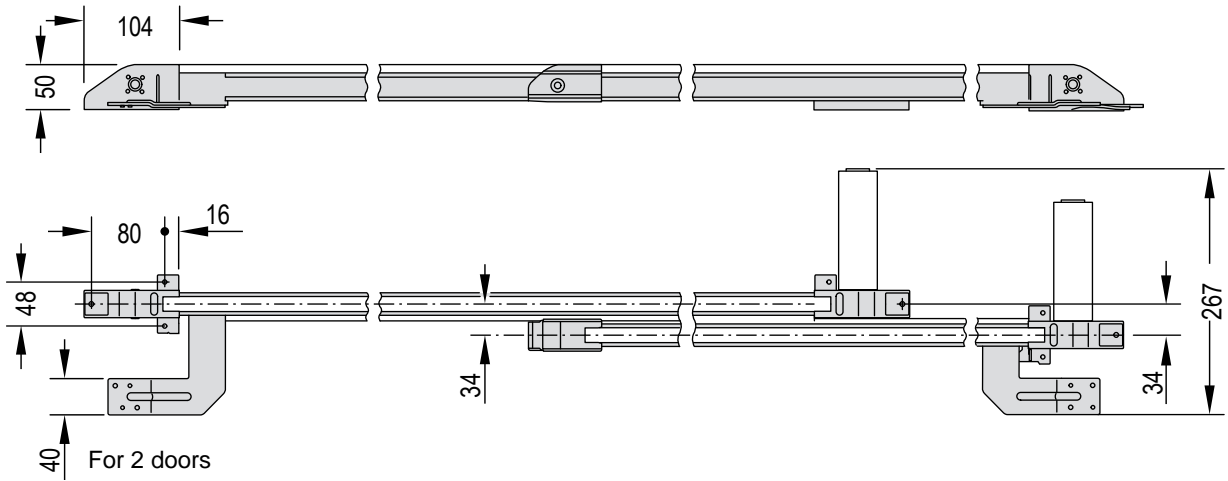



Classic 60 VF

E Drive for Classic 60 VF

- Suitable for : For 2 doors (wood or aluminium frames)
- Functionality : Activation with push button or radio remote control
- Installation : Track for screw fixing to cabinet behind running track



Article No.: 400.50.552

- 1 Controller
- 1 Adapter
- 1 Adapter cable
- 1 Remote
- 1 Normal cable



Product Name	Article No.	
Motion transmission bar for E-Drive - TYPE A*	400.50.550	
Motion transmission bar for E-Drive - TYPE B*	400.50.551	
Kit of connector brackets for upper slide to E- Drive	400.50.556	
Profile for E- Drive	400.50.967	

	Panel Width	No. of Doors	Article No.
TYPE A*	934-1296 mm	2	400.50.550
TYPE B*	1154-1500 mm	2	400.50.551

Sectional View of Classic 60 VF

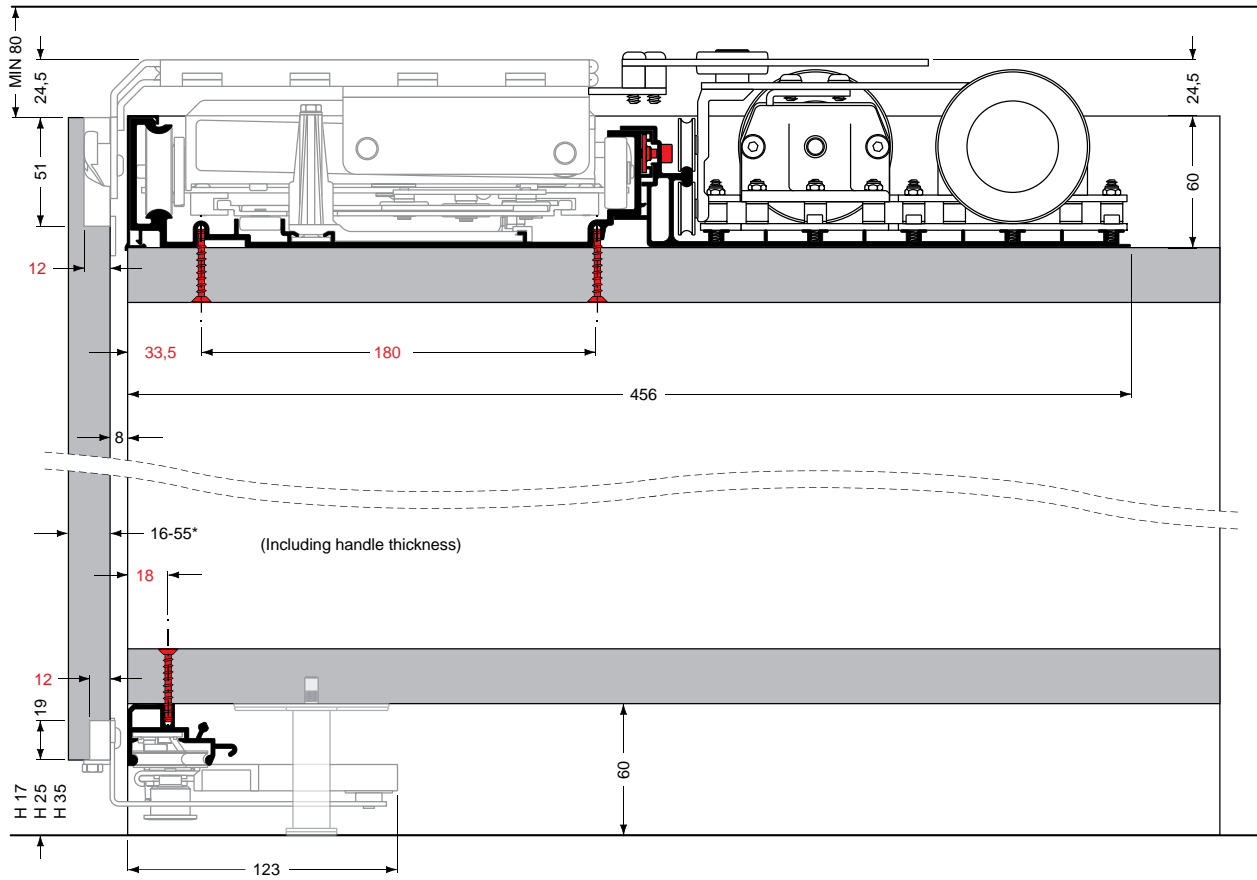

Top View of Classic 60 VF

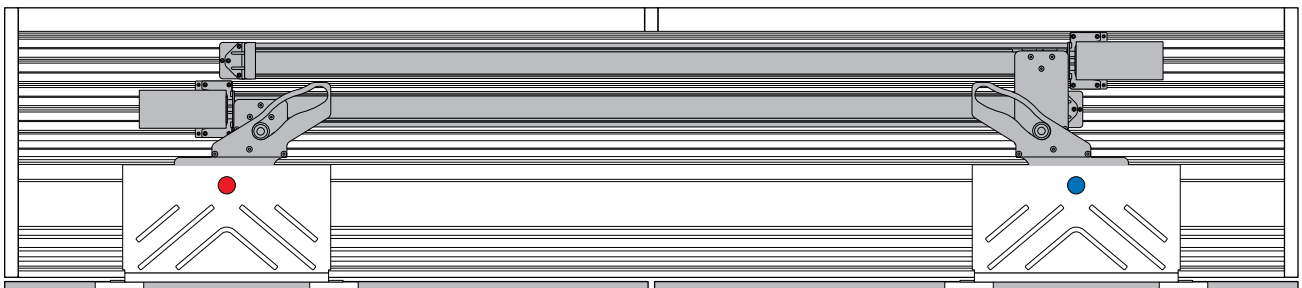



Classic Duo 80 VF

E DRIVE FOR CLASSIC DUO 80 VF

- **Suitable for :** For 2 & 3 doors (wood or aluminium frames)
- **Functionality :** Activation with push button or radio remote control
- **Installation :** Track for screw fixing to cabinet behind running track

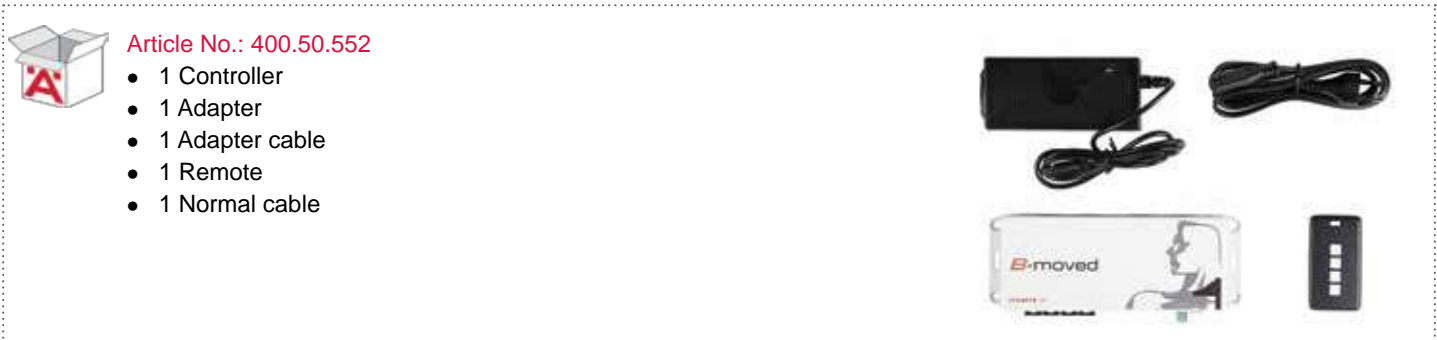

Product Name	Article No.	
Motion transmission bar for E-Drive -Type A*	400.50.550	
Motion transmission bar for E-Drive -Type B*	400.50.551	
Kit of connector brackets for upper slide to E-Drive system (2 doors)	400.50.554	
Kit of connector brackets for upper slide to E-Drive system (3 doors)	400.50.555	
Profile for E- Drive	400.50.966	

	Panel Width	No. of Doors	Article No.
TYPE A*	900-1400 mm	2	400.50.550
TYPE A*	1190-1400 mm	3	400.50.550
TYPE B*	1154-1800 mm	2	400.50.551
TYPE B*	1154-1800 mm	3	400.50.551

Positioning of the upper locks



Wardrobe with two overlapping doors

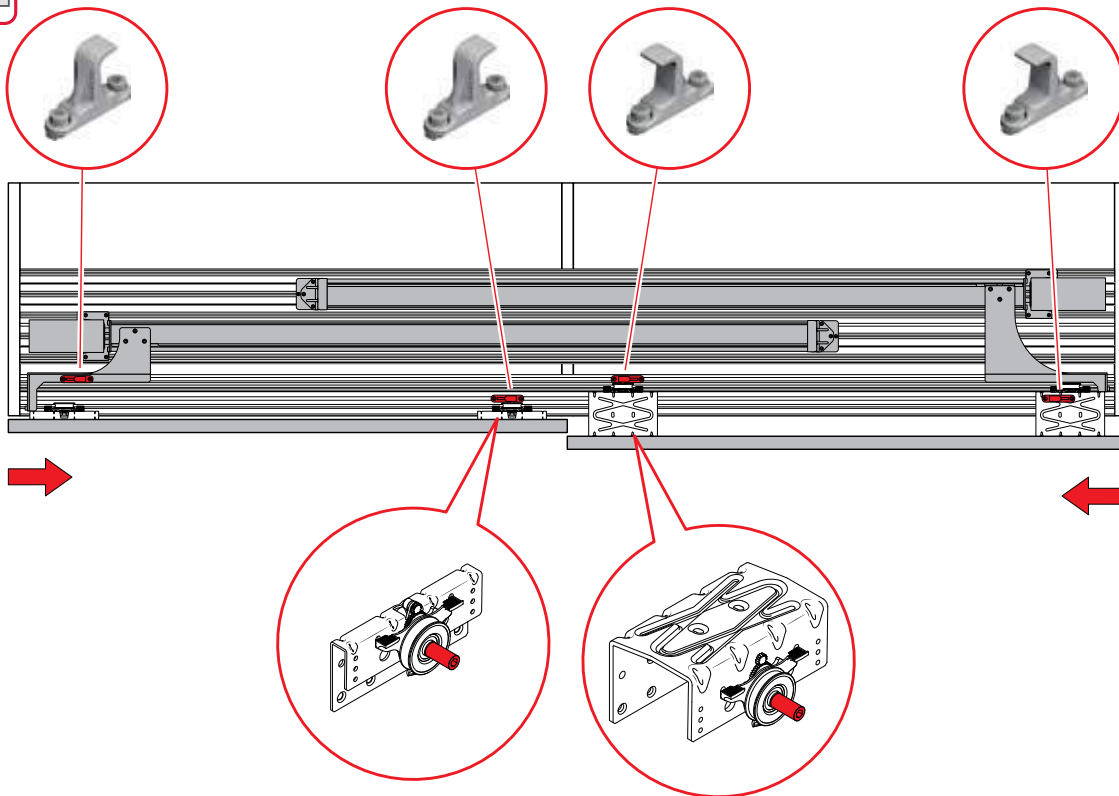

Wardrobe with two overlapping doors

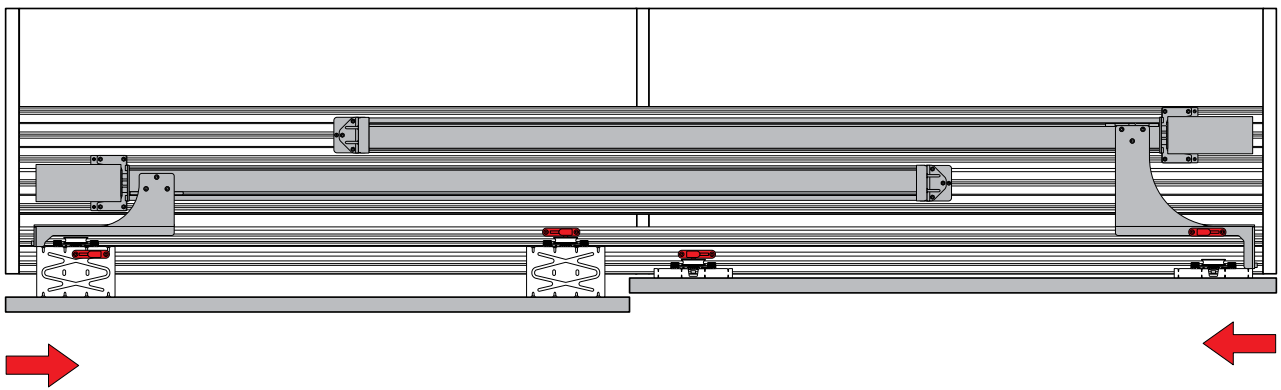

Wardrobe with three overlapping doors

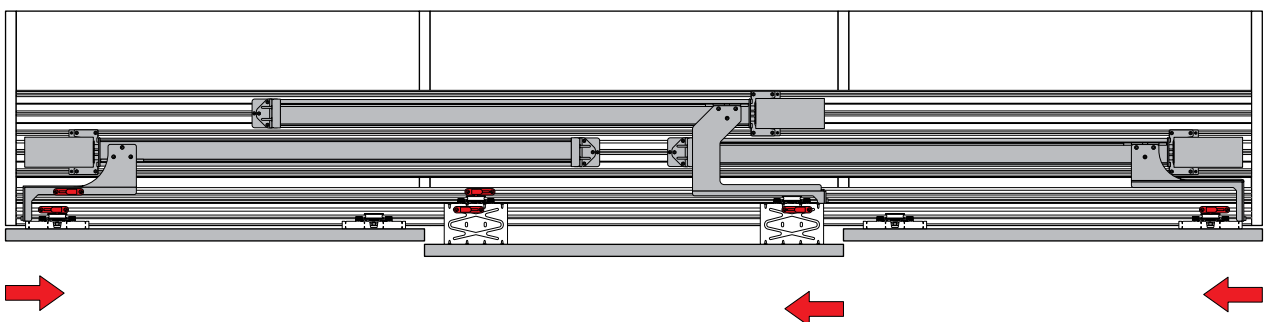

AUTOTEC AUTOMATIC DOORS







Autotec Alpha Drive

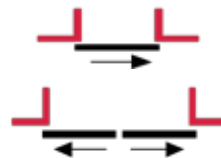
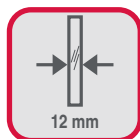

Hardware Specification :

- High load capacity up to 125 kg
- Door thickness 12 mm
- Automatic sliding system for internal glass doors
- Comes configured with an energy saving system which leads to lower power consumption (less than 0.5 W)
- Boasts of 70% less electricity consumption
- Highest level of safety – EN16005 standard
- Cycle testing: 10,00,000 cycles

Features :

- The system has a smooth and silent operation due to the roller and track mechanism
- Different configurations (modes) are available as per the application desired
- In case of power failure, there is an option of battery backup
- IP54 rated - Limited dust ingress and protection against water spray (canopy is required if the system is exposed to the external environment)

Note: If you place the order using the individual components (as listed below), please order the track separately. Alternately if you place the order using the BOM Articles (mentioned in the BOM LIST table), the track is included.

935.06.000

Assembly Kit for Drive

- 1 Controller EC4
- 2 End Stoppers
- 1 Motor
- 2 Rollers
- 1 Pulley
- 2 Maintenance Holders
- 2 Cover Holders
- 1 Distribution Box
- 1 Belt Clamp
- 6 Wire Holders
- 1 Cable For Motor
- 1 Electric Socket
- 2 Safety Thread













935.06.001

Additional Assembly Kit for Double doors









- 2 Rollers
- 1 Belt Clamp
- 2 Cover Holders
- 4 Wire Holders

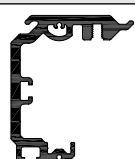

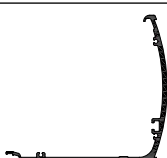
ACCESSORIES

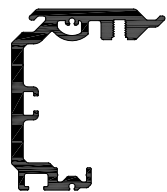
Product Name	Article No.	
Accessory for sensor installed on the cover	935.06.021	
Rubber for operator	935.06.022	
Assembly kit for lateral cover L+R SL300	935.06.023	
BELT	935.06.039	
HR100CT active IR motion and presence sensor	935.06.083	
Microwave movement sensor Hr-50	935.06.084	
COM 20 advanced module selector	935.06.082	
Autotec glass clamp offset	941.10.100	
SS Clamp for Sly glass rollers	941.10.020	
OPTIONAL		
Battery BU3	935.06.019	
ES lock EL5	935.06.018	

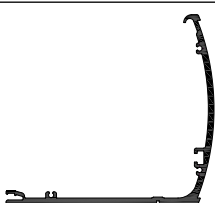
TRACK

Product Name	Article No.	 L mm	Finish	
Running track 4.2m (profile d11)	935.06.011	4280 mm	Silver anodised aluminium	
Profiles module carrier 4.2m (profile 13)	935.06.012	4280 mm	Silver anodised aluminium	
Cover profiles 4.2m (profile d14)	935.06.013	4280 mm	Silver anodised aluminium	
Track profiles for seal 4.2m(profile d8)	935.06.015	4280 mm	Silver anodised aluminium	
Running track 6.28m (profile d12)	935.06.006	6280 mm	Silver anodised aluminium	
Profiles module carrier 6.6m (profile d13)	935.06.007	6280 mm	Silver anodised aluminium	
Cover profiles 6.6m (profile d14)	935.06.008	6280 mm	Silver anodised aluminium	
Track profiles for seal 6.28m (profile d8)	935.06.010	6280 mm	Silver anodised aluminium	

BOM LIST (Track Included)	
Description	Article No.
Single door kit with 4.28 track with lock & battery, mode selector with a touch screen (COM 20)	935.06.106
Double door kit with 4.28 track with lock & battery, mode selector with a touch screen (COM 20)	935.06.107
Double door kit with 6.28 track with lock & battery, mode selector with a touch screen (COM 20)	935.06.108
Single door kit with 4.28 track with lock & battery, mode selector with a touch screen (COM 20) and double side safety sensor- HR100CT	935.06.109
Double door kit with 4.28 track with lock & battery, mode selector with a touch screen (COM 20) and double side safety sensor- HR100CT	935.06.110
Double door kit with 6.28 track with lock & battery, mode selector with a touch screen (COM 20) and double side safety sensor- HR100CT	935.06.111

Single Door Installation with Offset Glass Bracket

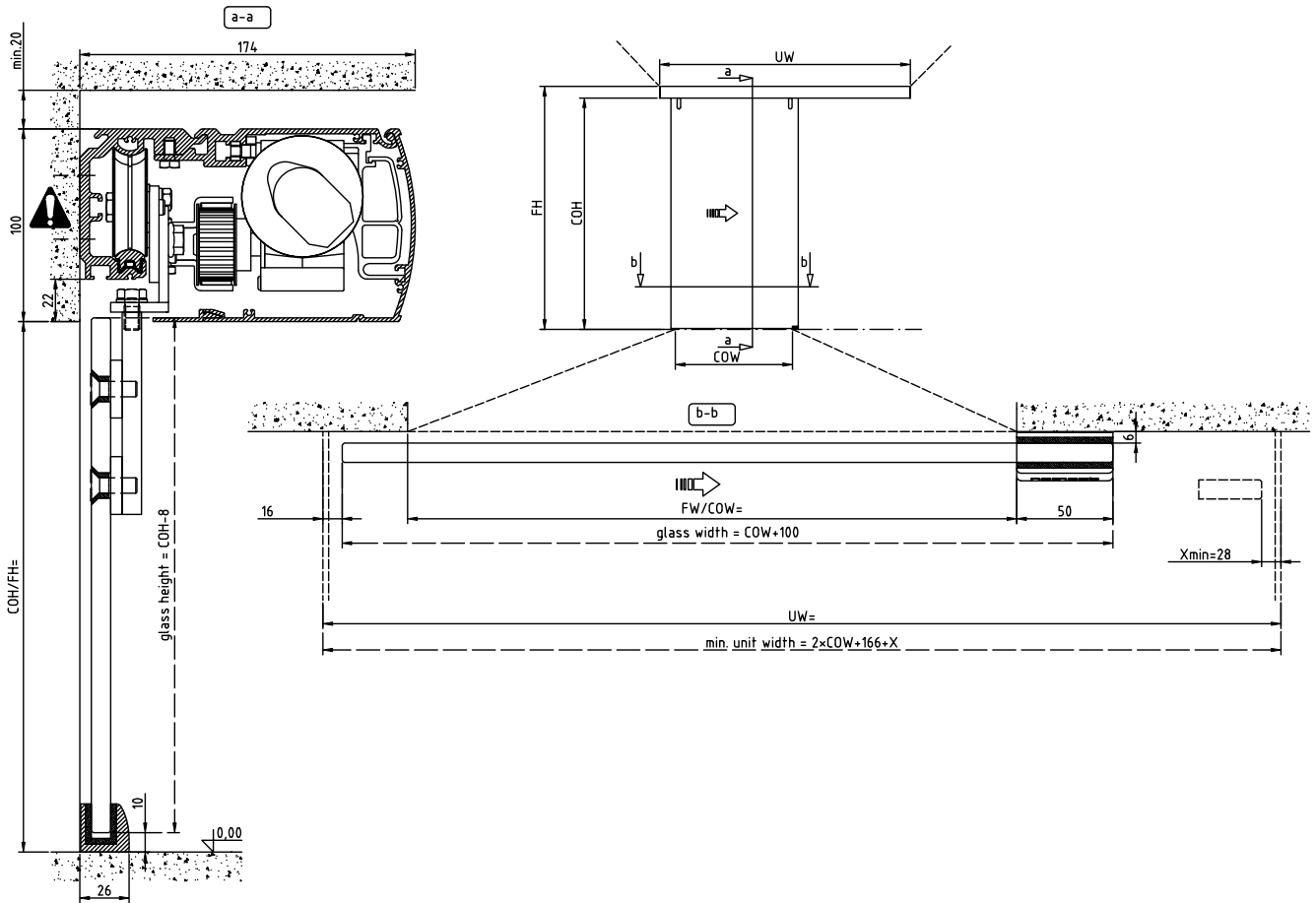

FW	Frame Width	Min. 800 /Max. 1500	<p>COW = FW COH = FH UW (Min.) = (2 × FW) + 166 + X approx. Xmin = 28</p>
COW	Clear Opening Width	Min. 800 /Max. 1500	
FH	Frame Height	Min. 1900 /Max. 3000	
COH	Clear Opening Height	Min. 1900 /Max. 3000	
UW	Min. Unit Width	Min. 1670 /Max. 6500	
X	Safety Distance	Xmin = 28	

Note: If there are no walls on the path of the sliding doors, you do not need to consider the safety distance.

**Double Door Installation with Offset
Glass Bracket**

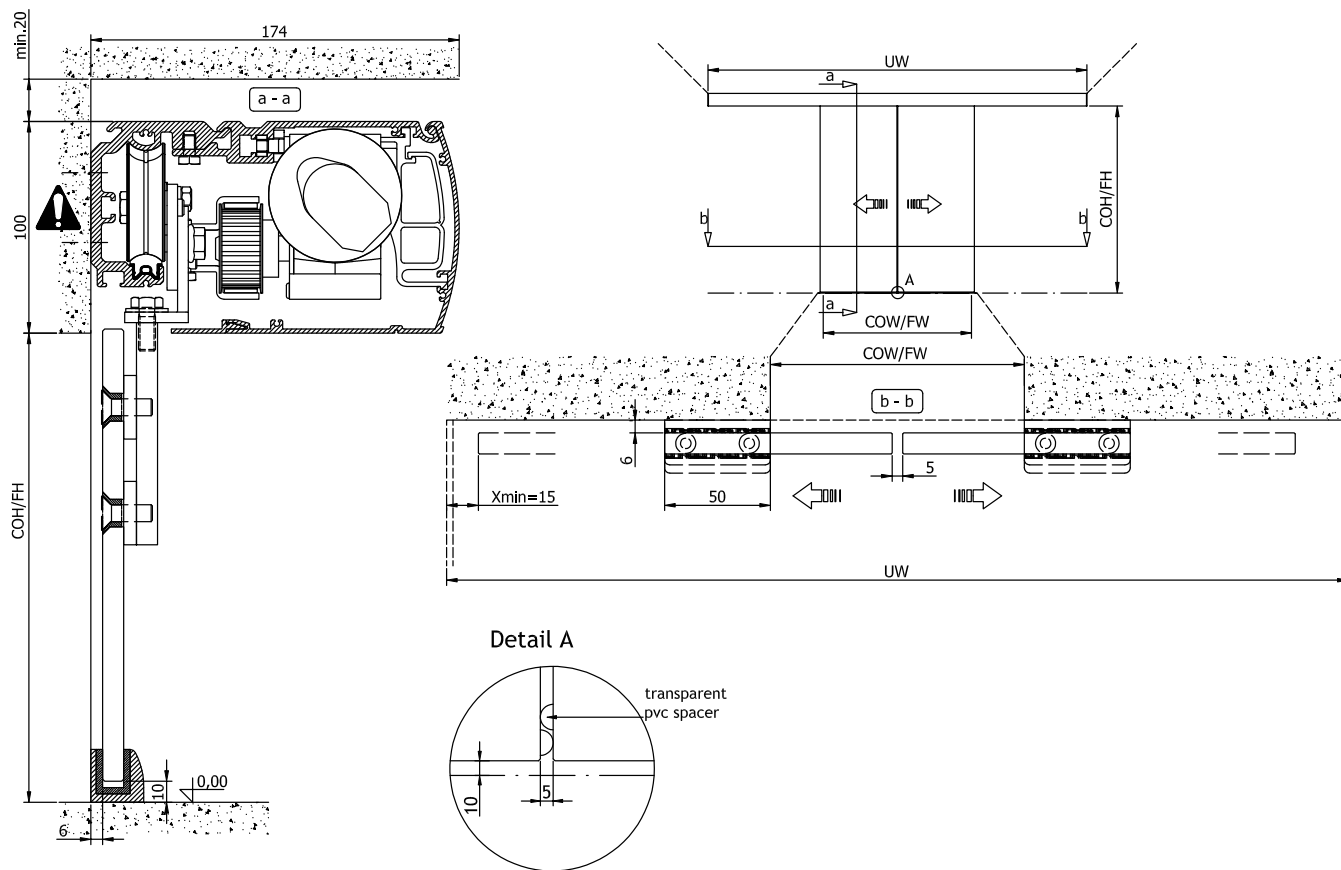

FW	Frame Width	Min. 800 /Max. 3000	<p>COW = FW COH = FH $UW = (2 \times FW) + 95 + (2 \times X)$ approx. Xmin = 15</p>
COW	Clear Opening Width	Min. 800 /Max. 3000	
FH	Frame Height	Min. 1900 /Max. 3000	
COH	Clear Opening Height	Min. 1900 /Max. 3000	
UW	Min. Unit Width	Min. 1670 /Max. 6500	
X	Safety Distance	Xmin = 15	

Note: If there are no walls on the path of the sliding doors, you do not need to consider the safety distance.

GLASS CUT-OUT DIMENSIONS

Installation with Offset Glass Bracket

Single Door

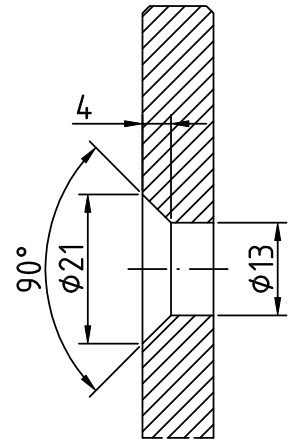
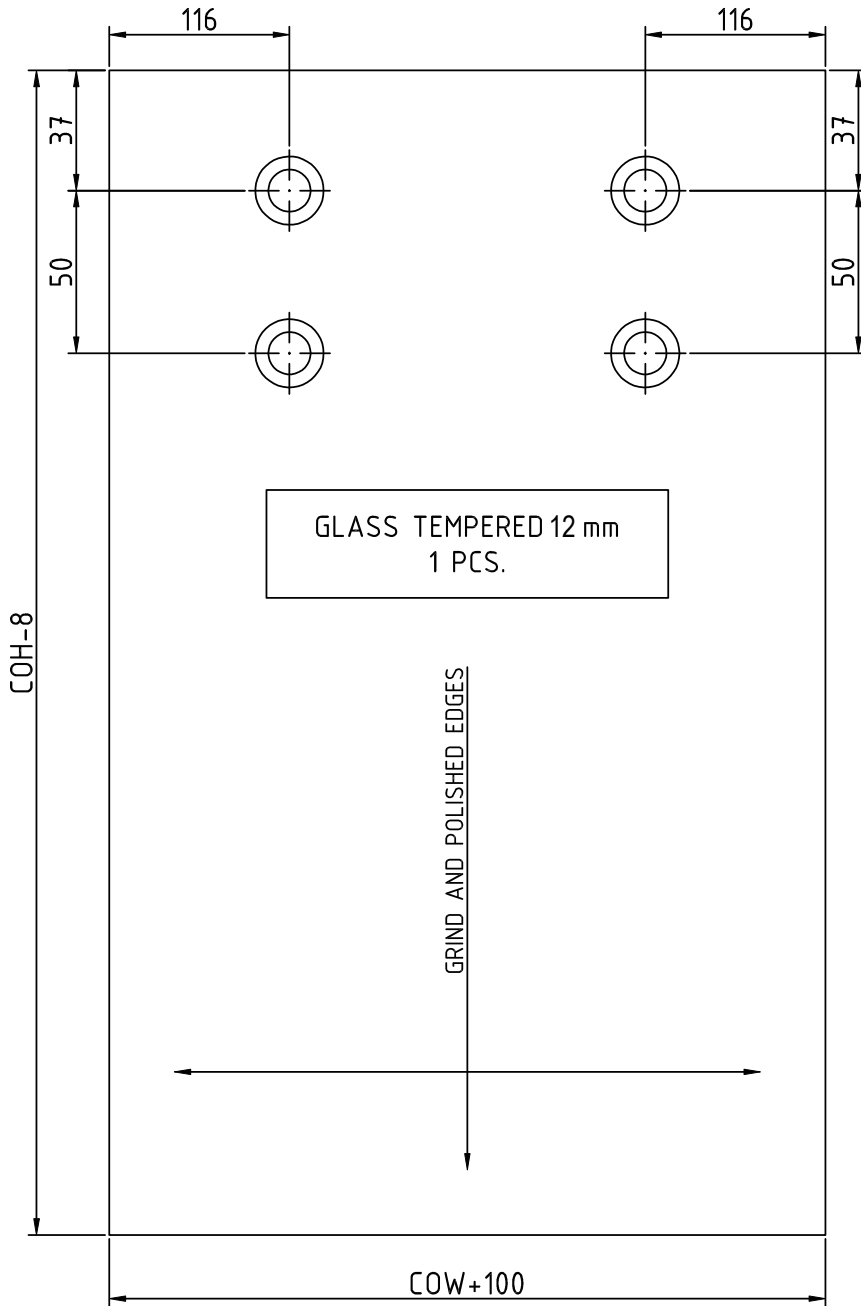

Double Door

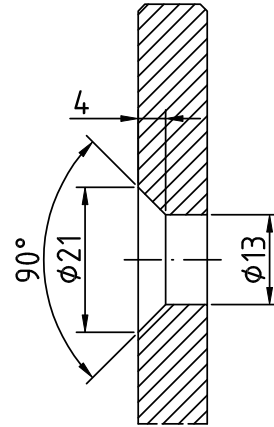
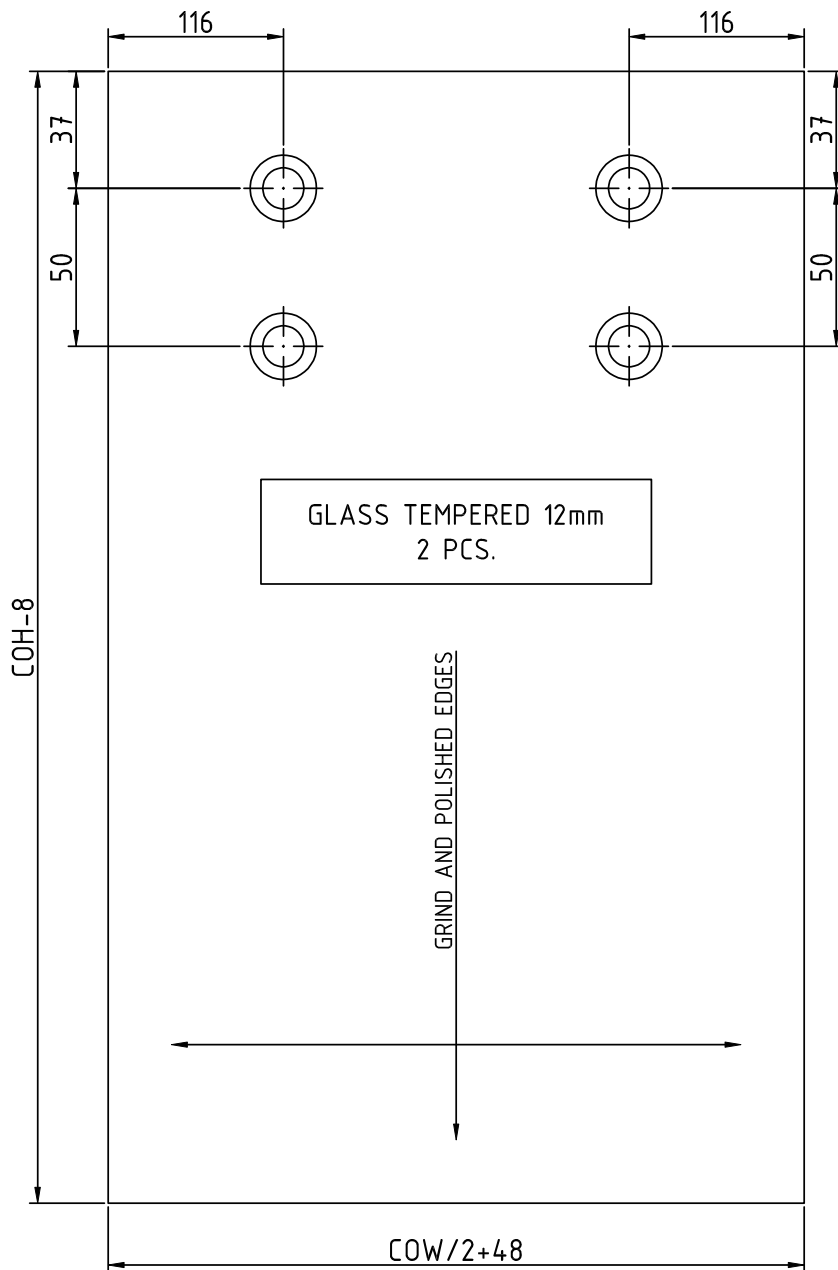

Installation with Standard Glass Bracket

Single Door

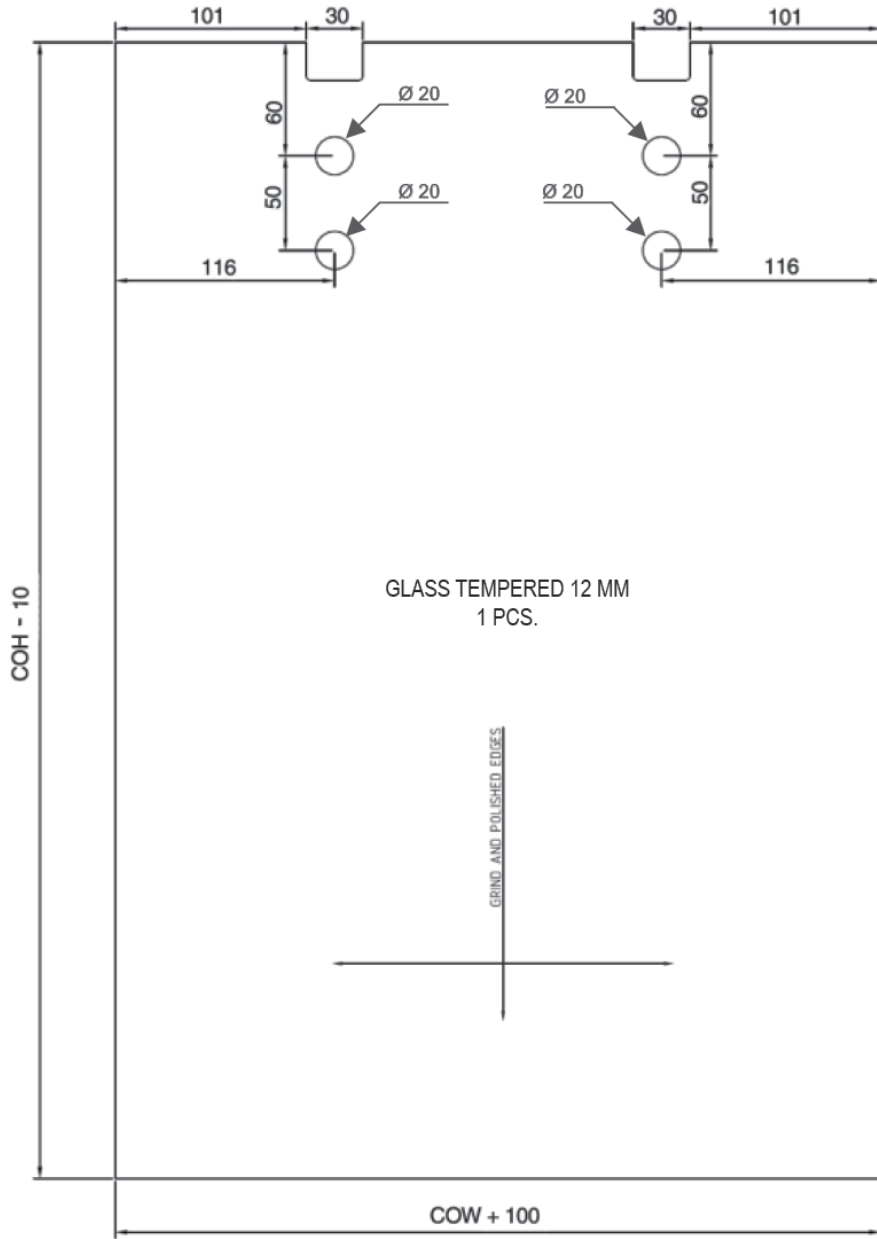

Double Door

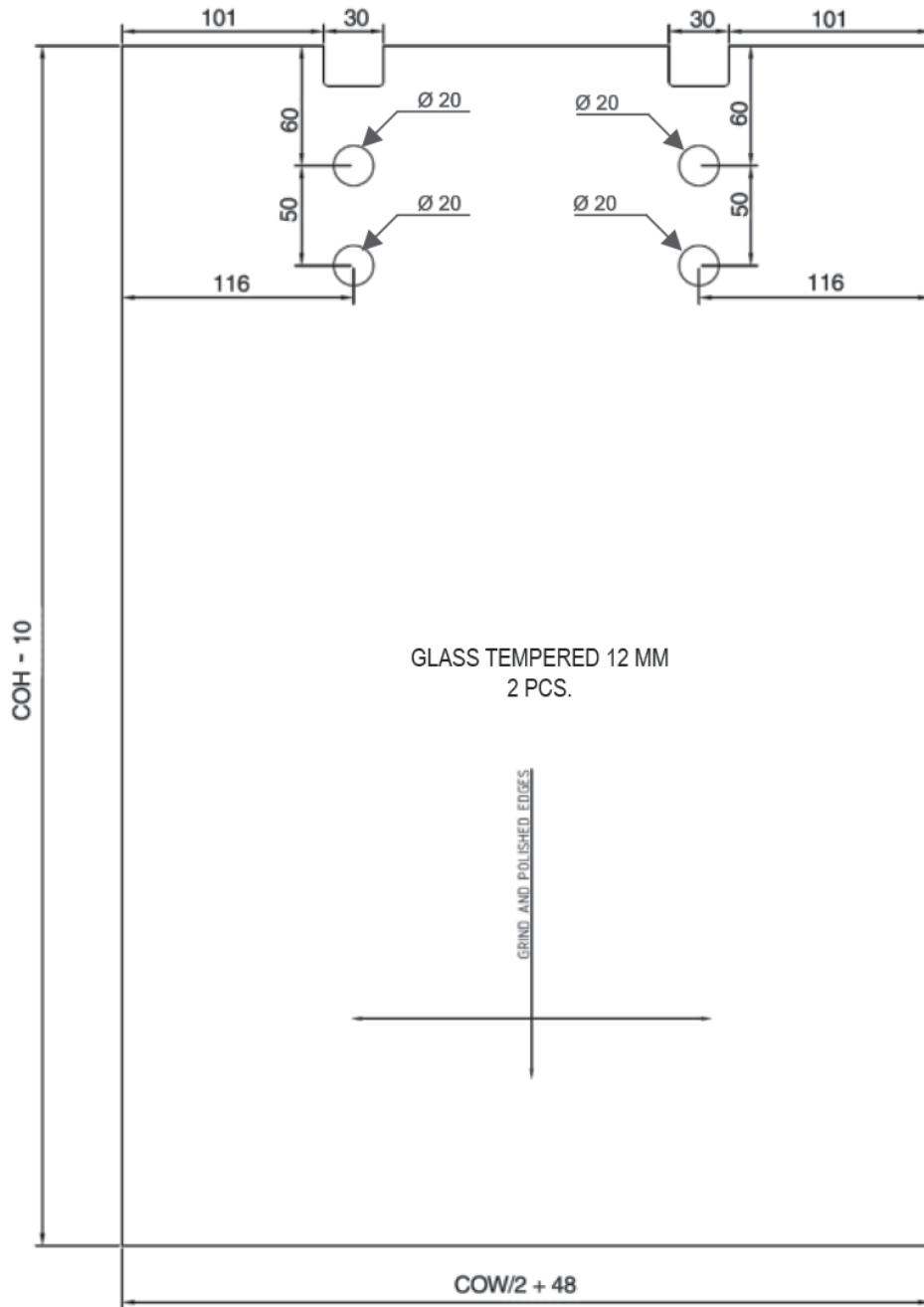

Autoslide

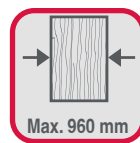
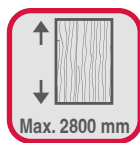

Autoslide can be installed only on wooden doors

Hardware Specification :

- Max. door weight for single door up to 100 kg
- Max. door weight for double door up to 60 kg
- Max. door width: 960 mm (37 inches)
- Power supply: 110-240 V AC, 24V DC Power Adapter
- Safety cut-off: Yes
- Automatic to manual mode: Yes
- Autoslide drive unit dimensions:
 - Length: 490 mm (19 in)
 - Height: 70 mm (2.75 in)
 - Width: 65 mm (2.5 in)

Features:

- Converts any manual sliding (under 100kg) into automatic
- Cannot be installed with frameless glass sliding doors
- Intended for residential applications
- 5 star energy rating
- Helps save on air conditioning costs
- Power consumption: 40 Watts (equivalent to that of a CFL bulb)
- Easy installation
- For wooden & residential applications

Black Kit

940.27.000

- 1 Autoslide Drive Unit
- 1 Optional Mounting Bracket
- 2 Racks
- 2 End Rack Caps
- 2 Wireless Push Button Controls
- 1 Friction Tester
- 1 Power Adapter
- 1 Switch Operator
- Various Screw Fittings
- Installation DVD

Autoslide with motor lock- Black

940.27.437







- 1 Autoslide Drive Unit
- 1 Optional Mounting Bracket
- 2 Racks
- 2 End Rack Caps
- 2 Wireless Push Button Controls
- 1 Friction Tester
- 1 Power Adapter
- 1 Switch Operator
- Various Screw Fittings
- Installation DVD

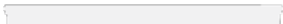

White Kit

940.27.001

- 1 Autoslide Drive Unit
- 1 Optional Mounting Bracket
- 2 Racks
- 2 End Rack Caps
- 2 Wireless Push Button Controls
- 1 Friction Tester
- 1 Power Adapter
- 1 Switch Operator
- Various Screw Fittings
- Installation DVD

Product Name	Article No.	
500 mm add-on rack: Black (to achieve wider opening)	940.27.402	
500 mm add-on rack: White (to achieve wider opening)	940.27.412	
Remote control	940.27.430	
Human sensor with wire connected to the drive unit	940.27.431	
Sensor with battery	940.27.432	
Wall mounted wireless push button	940.27.433	
Pressure mat sensor	940.27.434	
Power extension cord: White	940.27.435	
Additional 5 meter cable to connect the drive unit to switches, sensors, keypad activation, card access etc. that do not belong to Häfele	940.27.436	

Section View:

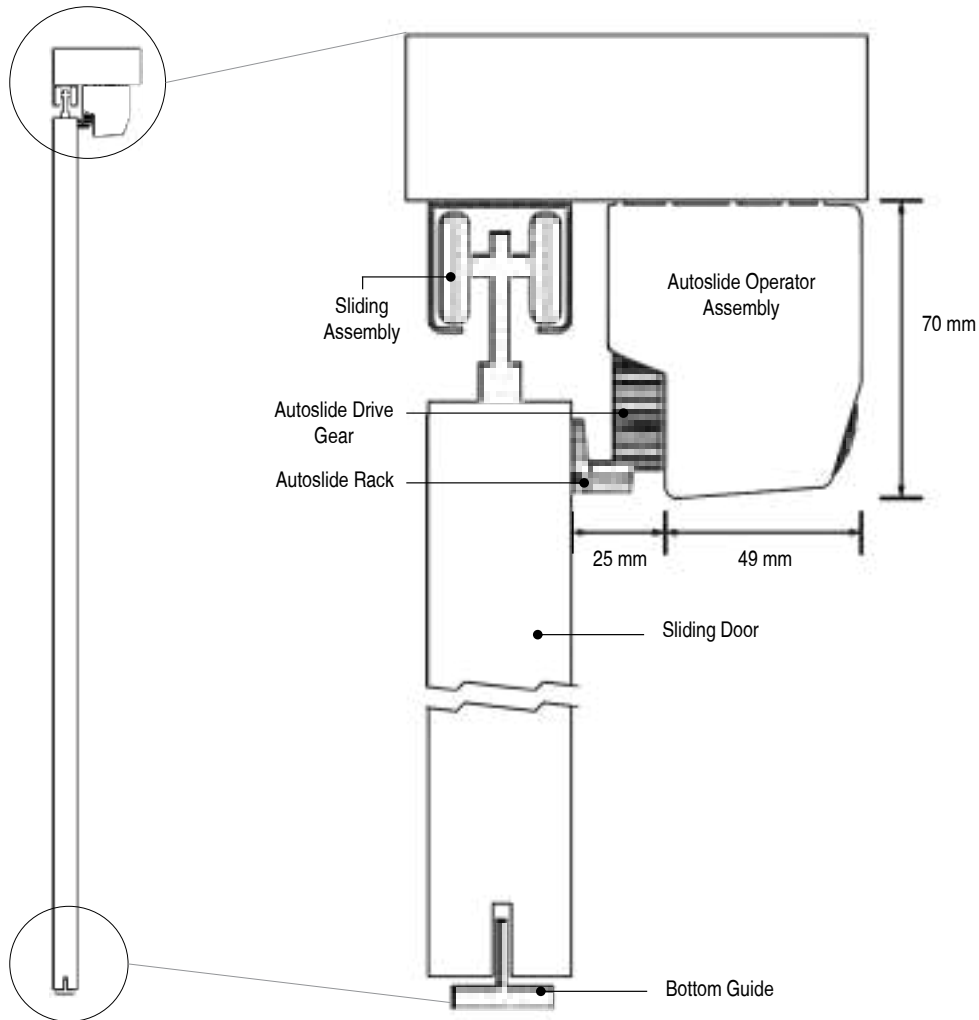

Position 75mm past edge of opening door



Closed Position

490mm

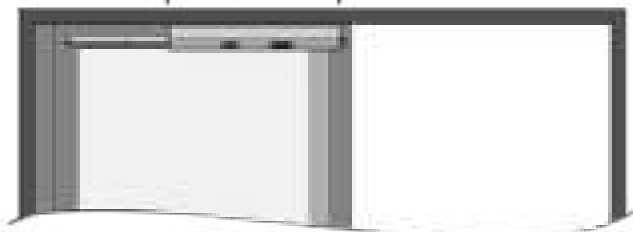

Open Position

Allow a 75 mm overlap of the Autoslide Drive Unit from the past edge of the opening door when the door is in the closed position

Autoslide Mounting Possibilities

TOP MOUNT, OVER CLEAR OPENING



TOP MOUNT, OVER FIXED PANEL

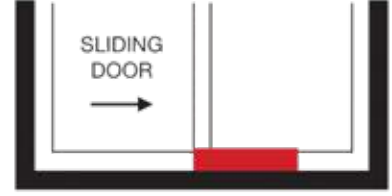

BOTTOM MOUNT

Mounting possibilities over fixed panel



Top Mount, Right Opening



Top Mount, Left Opening

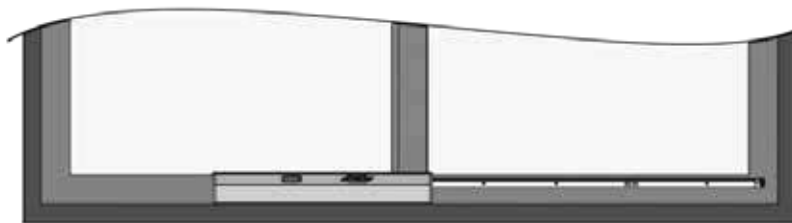

Bottom Mount, Right Opening



Bottom Mount, Left Opening

Programming DIP Switches

The Autoslide Drive Unit comes with 8 switches that helps the door learn and program itself as per the functionality desired by the user

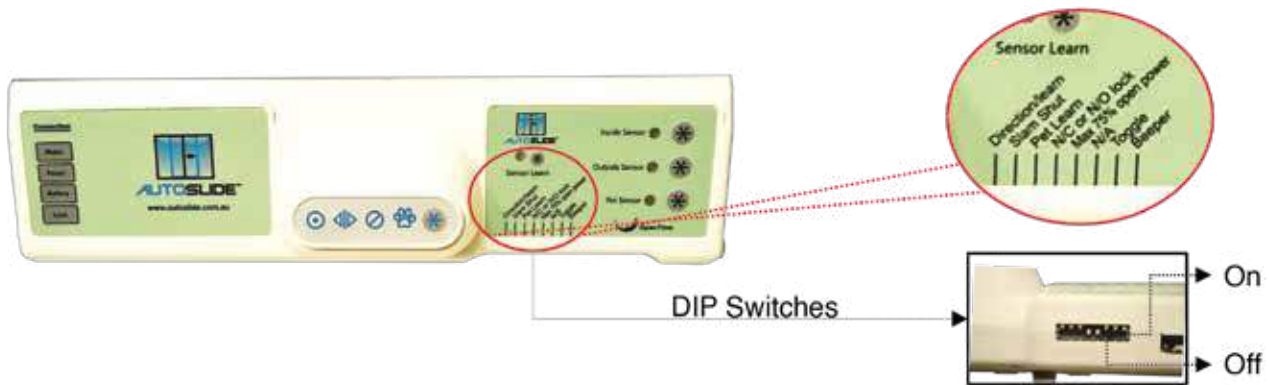

DIP Switch	On	Off
1.Direction	Left Opening	Right Opening
	Toggle (back and forth) to erase memory and re-learn the open/close cycle. Lights will blink and system will self-calibrate again	
2.Slam Shut	Helps overcome resistance	Normal Operation
3.Pet Learn / Partial Opening	Toggle to start pet / partial opening size learn cycle. To have a partial opening, toggle this switch once, the door will then slide towards its closing position. Once it reaches the desired position stop the door. After this, the system will remember this setting.	
4.External Lock	If using an external digital lock	If not using an external lock
5.Less Power / Soft Close	Operates at 75% of the normal speed	Normal Operation
6.N/A	N/A	N/A
7.Toggle	Door does not respond to the automatic closing mode. The wireless push button needs to be activated to open the door post which it continues to rest in the open position. It needs to be activated again in order to close it.	Normal Operation
8.Beeper	Beeper enabled	Beeper disabled

Functioning Modes

Once the door operates in the manner desired by the user through the DIP switches, the preferred mode can be selected

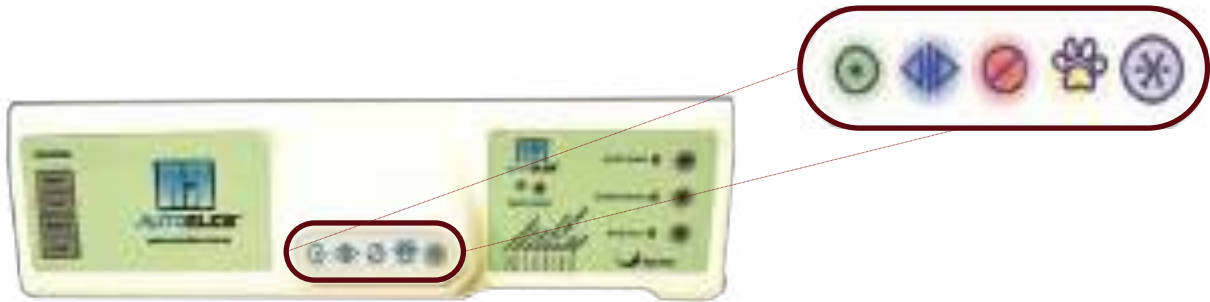

Automatic mode (Green LED)	The door will open when a sensor is triggered and close after the preset dwell time has elapsed.
Hold open mode (Blue LED)	The door will open and remain open until another mode is selected.
Standby mode (Red LED)	The door can be manually operated. The door in this mode will not be driven by Autoslide
Pet / Partial opening mode (Yellow LED)	The door will open to the partial opening width when any safety sensor is triggered and will close after the present dwell time has elapsed. This mode can successfully function only with the installation of a human sensor (details on the next page) and only if the partial opening width has been set.

The desired mode is selected by successive presses of the Mode button (●), to the right of the LED display. The modes will cycle in the order shown above (although the pet mode will be omitted if no pet opening width has been set). The selected mode will engage after a short delay.

**Mumbai Design Centre:**

Haji Moosa Patrawala Ind.(SOBO)
Estate, Near Famous Studio,
Mahalaxmi (West), Mumbai - 400 011.
Tel.: 022 6264 7100.

Mumbai Design Centre:

#2 Filix Building, Opp. Asian Paints,
L.B.S. Marg, Bhandup (West),
Mumbai - 400 078.
Tel.: 022 2596 9660/
2596 9787/2594 7305

New Delhi Design Centre:

D-89 , 1st Floor, Okhla Phase-I,
New Delhi - 110 020.
Tel.: 011-66574999 .
Fax: 011-41605482.

Bangalore Design Centre:

Incubex Nestavera Spaces Pvt Ltd,
No:13, Langford Place, Langford Road,
Shanti Nagar, Bangalore - 560 025.
Tel.: 080 4132 6116.
Fax: 080 4132 6226.

Hyderabad Design Centre:

SJR Building - # 1-57/89/1 & 1-57/89/2
Opp Allahabad Bank, Gachibowli,
Hyderabad – 500032.
Tel.: 040 29557578 / 040 29557588

Kolkata Design Centre:

PS PACE, Premises No. 1/1A,
Mahendra Roy Lane, Topsia,
Kolkata - 700 046.
Tel.: 033 40086814 / 033 40089268
Fax: 033 24988020.

Chennai Design Centre:

First Floor No.24, College Road,
Nungambakkam, Chennai 600 006.
Tel.: 044 - 4215 1542
Fax: 044 2446 0922.

Pune Design Centre:

Showroom No. 2, Ground Floor,
F P no. 403, A/2, ICC Trade tower,
Senapati Bapat Marg,
Shivaji Nagar, Pune -411016
Tel.: 020 2563 3301
Fax: 020 2563 3302

Pune Office:

Office No. 12, Vastushree Complex,
Survey No.587,
Near Hyde Park, Gultekdi,
Market Yard, Pune - 411 037.
Tel.: 020 2426 6264
Fax: 020 2426 6274.

Ahmedabad Office:

Hafele India Pvt. Ltd., Office No. 302, 3rd
Floor,, Shangrila Arcade, Near Shyamal
Cross Road, Satellite,
Ahmedabad - 380015.
Tel.: +91 79695 55505 / 8866220505.

Sri Lanka:**Hafele Design Centre:**

52, Nandana Gardens
(On Duplication Road), Colombo 04.
Tel: +94 112 500 501.
Fax: 0094 112 500 553.

Hafele Design Centre:

448, Galle Road, Rawathawatta,
Moratuwa, Sri Lanka.
Tel.: +94 112 644 600.

Hafele Boutique:

747A, Sirimawo Bandaranayaka
Mawatha, Mulgampola,
Kandy, Sri Lanka.
Tel.: +94 812 223 338.

Bangladesh Office:

2nd Floor, House - 181, Road - 2,
Mohakhali DOHS, Dhaka - 1206.
Tel.: 01844018431/ 01844018432/
01844018433/ 01844018437.

Bangladesh Design Center:

House - 106, Road - 12,
Block - E, Banani, Dhaka - 1213
Phone - 02-48810380-81

Nepal:

Monika Home Decor
Kathmandu Plaza, Kamalddhi,
Kathmandu, Nepal
Tel.: 00 9851 030 556 /
00 977 9818496082 / 9851030556

Bhutan:**SMART HOMES**

Gr Floor, Druk Building (Opp Helipad)
Babesa -Thimpu Expressway, Thimpu
Tel.: +975-2-333419
Mobile: +975-77277615, 17839717,
77114228,1760063,17669840

HÄFELE

Mumbai Corporate Office:

Office No. 3, Building "A", BETA,
I Think Techno Campus, Off J.V.L.R.,
Opp. Kanjurmarg East, Mumbai – 400 042.
Tel.: 022 6142 6100 • Fax: 022 6702 0531.

For Enquiries SMS "HAFELE" to 56070

Toll Free Customer Care: 1800 266 6667
Customer Care WhatsApp: +91 97691 11122
customer care@hafeleindia.com
info@hafeleindia.com

Follow us on

